

PIN HEADER 1.27mm

Pin Header 1.27mm 1 Row H=1.0/1.5/2.0/2.5mm SMT Type

TOPTTEK®

HARDWARE ELECTRONIC COMPONENTS



www.toptek-co.com



RoHS 2002/95/EC

Specifications

Current Rate: 1 AMP | Insulation Resistance: 1000MΩ | Max. Contact Resistance: 20mΩ |
Max. Dielectric Voltage: 500V AC for one minute | Operation Temperature: -40°C to +105°C

Material

Insulator: Polyester, UL 94V-0 | Standard: Nylon 6T | Terminal: Copper Alloy | Plating: Gold Plated

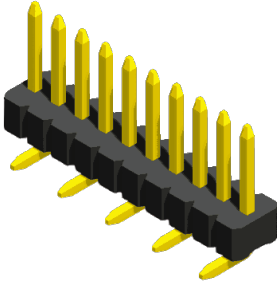

ORDER INFORMATION

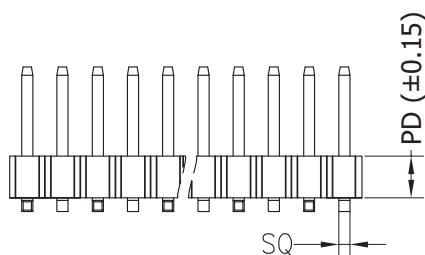
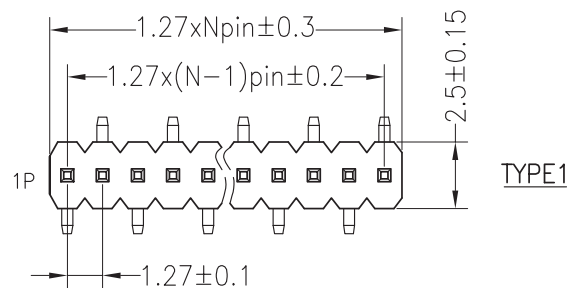
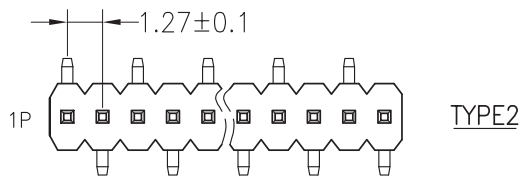
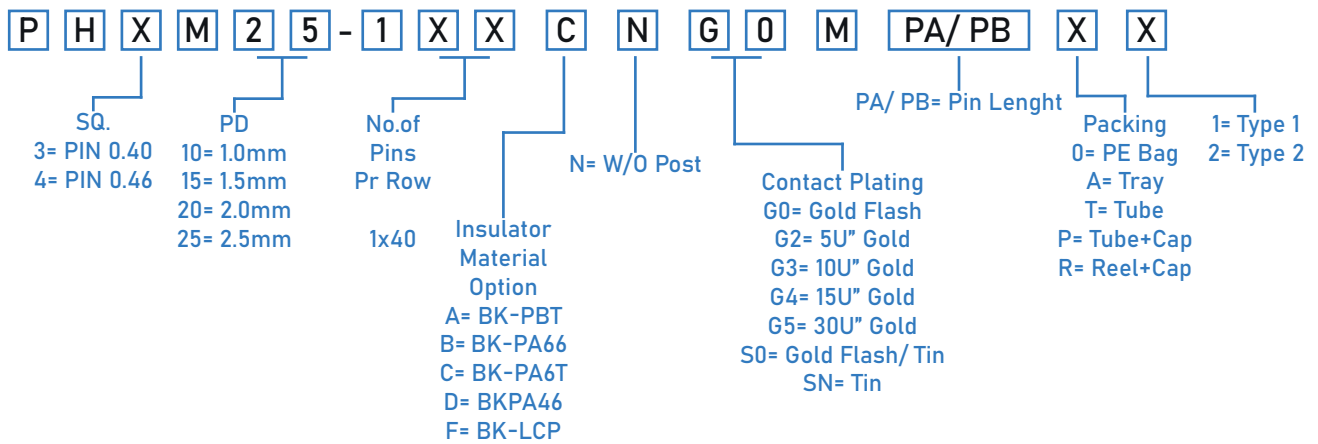

Recommended P.C.B Layout (Top Side)
(PCB BOARD TOLERANCE ±0.05)

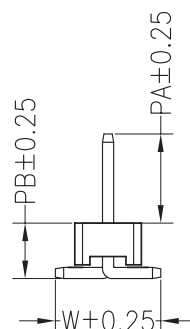
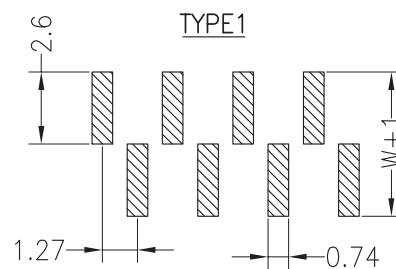
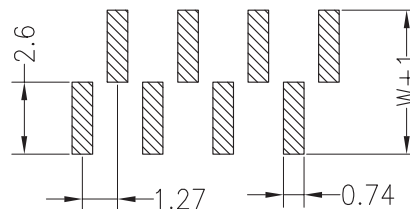

PD
1.00mm
1.50mm
2.00mm
2.50mm

ITEM	PA	PB
Standard	4.00	1.90

Alternate