

PIN HEADER 2.54

Pin Header 2.54mm 1 Row H=2.5mm C Type

TOPTTEK®

HARDWARE ELECTRONIC COMPONENTS



www.toptek-co.com



Specifications

Current Rate: 3 AMP | Insulation Resistance: 1000MΩ | Min. Contact Resistance: 20mΩ |
Max. Dielectric Voltage: 1000V AC for one minute | Operation Temperature: -40°C to +105°C

Material

Insulator: Hi-Temp. Thermoplastic, UL 94V-0 | Terminal: Copper Alloy | Plating: Gold Plated

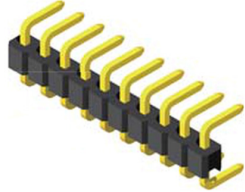

ORDER INFORMATION

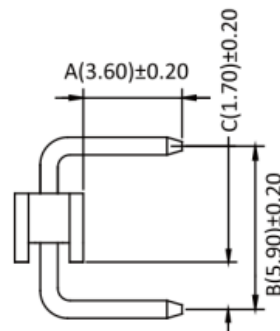
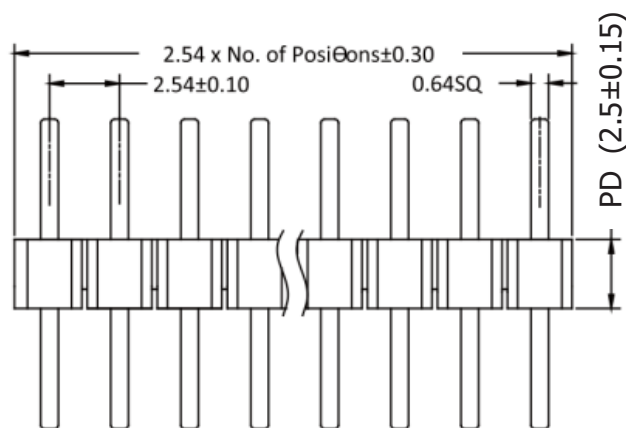
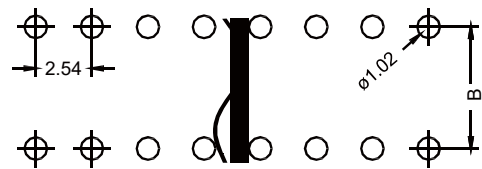
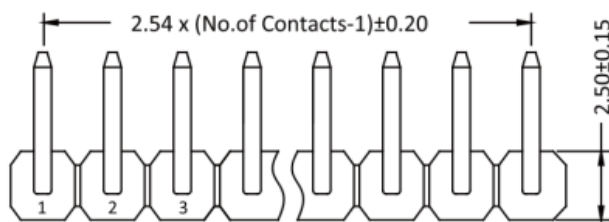
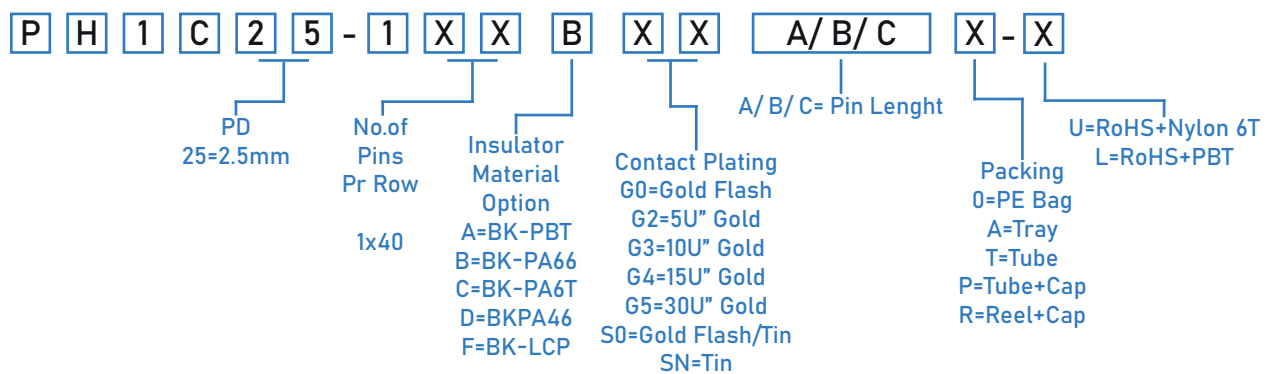

PD
2.50mm

ITEM	A	B	C
Standard	3.60	5.90	1.70
Alternate			