

CONNECTORS MANUFACTURER

Modular Jack Shielded Side Entry With LED H=25.4 W=27.9

Material & Finish:
 Housing: Glass Fiber, PBT, UL94V-0
 Contact: 0.35 mm Thickness Phosphor Bronze,
 Gold Plated Over Nickel on Contact Area,
 Tin Plated Over Nickel on Solder Area.

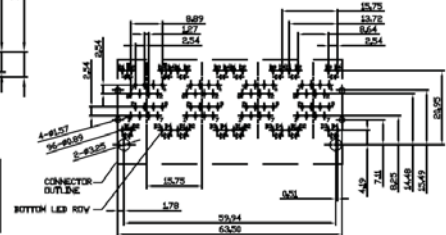
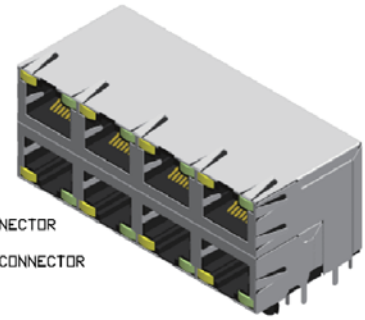
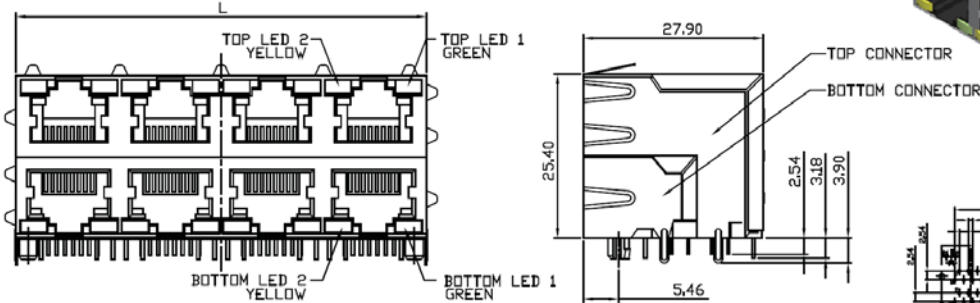

Port	201	202	203	204	206	208
Dim. L	16.45	32.10	47.85	63.75	95.10	126.60

Recommended PCB Layout
(PCB TOLERANCE ±0.05)

Order Information

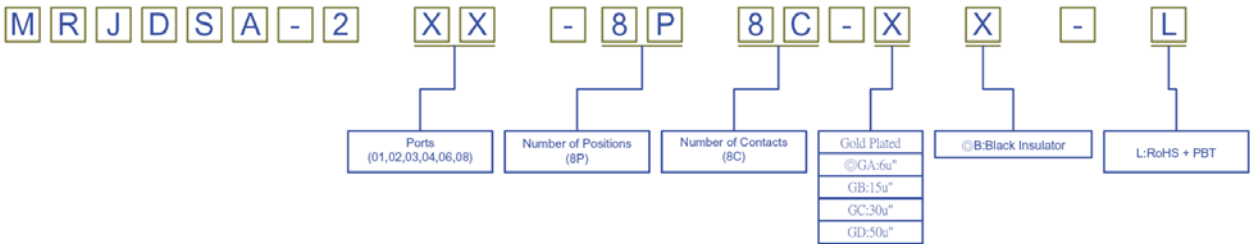

Modular Jack Shielded Side Entry With LED H=25.4 W=28.15

Material & Finish:
 Housing: Glass Fiber, PBT, UL94V-0
 Contact: 0.35 mm Thickness Phosphor Bronze,
 Gold Plated Over Nickel on Contact Area,
 Tin Plated Over Nickel on Solder Area.

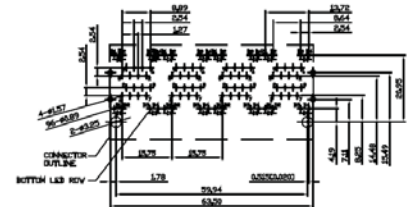
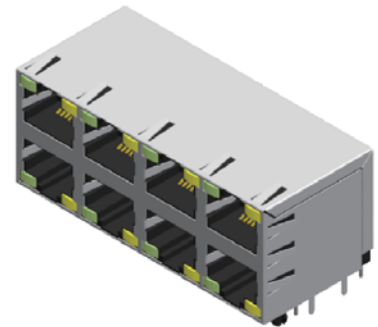
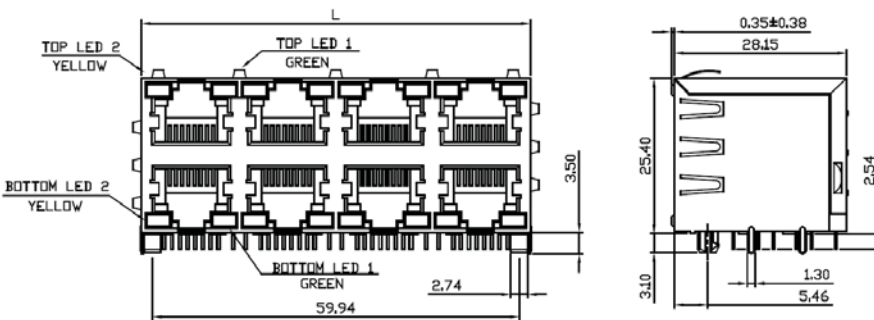

Port	201	202	204	206	208
Dim. L	16.45	32.10	63.75	95.10	126.60

Recommended PCB Layout
(PCB TOLERANCE ±0.05)

Order Information

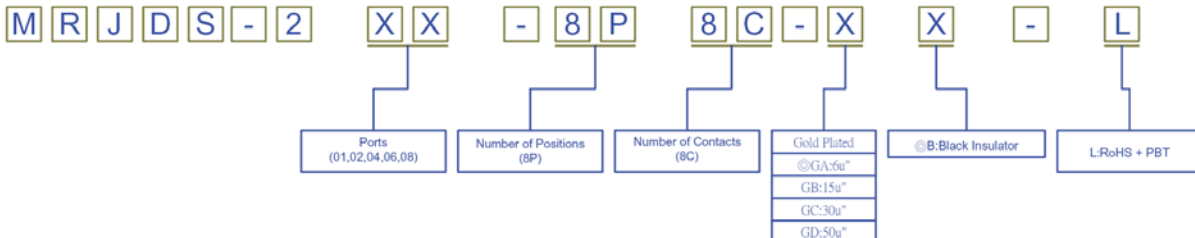

Modular Jack

RoHS