

# CONNECTORS MANUFACTURER

## Modular Jack Shielded Top Entry H=16.6 W=16.5

Material & Finish:  
 Housing: Glass Fiber, PBT , UL94V-0  
 Contact: 0.35 mm Thickness Phosphor Bronze,  
 Gold Plating Over Nickel on Contact Area,  
 Tin Plating Over Nickel on Solder Area.

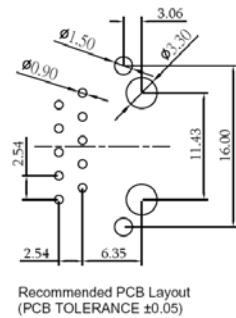
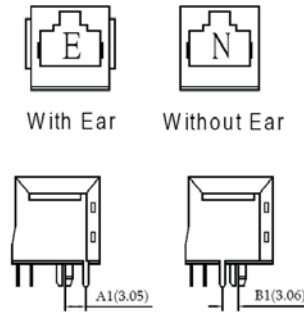
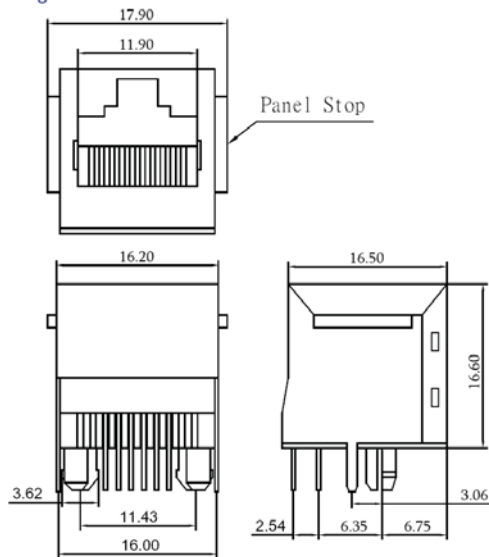
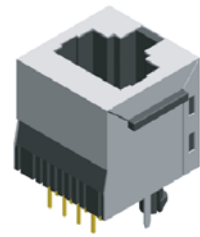

### Order Information

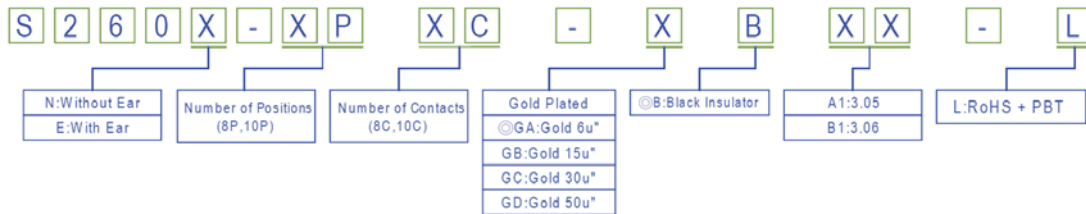

## Modular Jack Shielded Side Entry H=13.1 W=17.9

Material & Finish:  
 Housing: Glass Fiber, PBT , UL94V-0  
 Contact: 0.35 mm Thickness Phosphor Bronze,  
 Gold Plating Over Nickel on Contact Area,  
 Tin Plating Over Nickel on Solder Area.

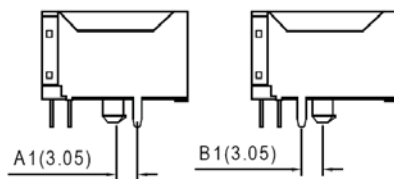
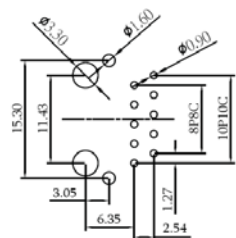
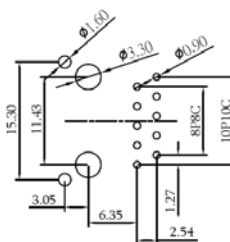
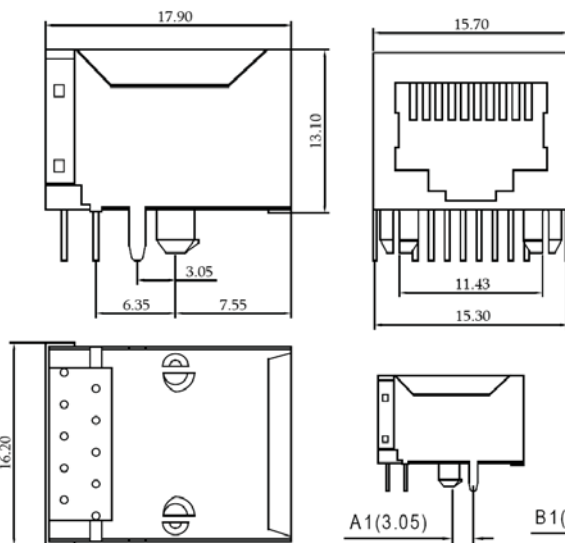
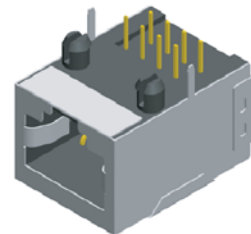

### Order Information

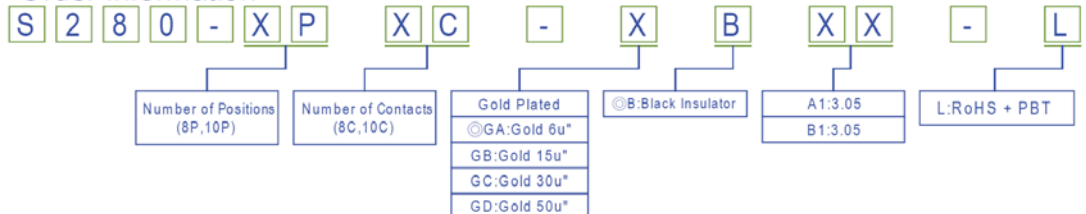

Modular Jack



ROHS