

CONNECTORS MANUFACTURER

Modular Jack Side Entry H=15.7 W=20.5

Material & Finish:

Housing: Glass Fiber, PBT, UL94V-0, Black
 Contact: 0.35 mm Thickness Phosphor Bronze,
 Gold Plating Over Nickel on Contacts Area,
 Tin Plating Over Nickel on Solder Area.

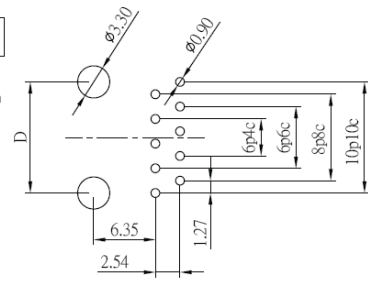
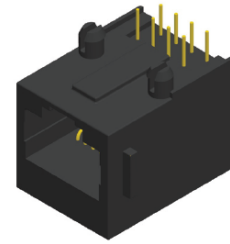
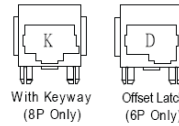
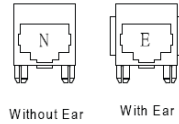
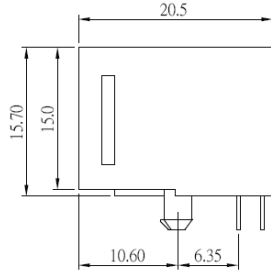
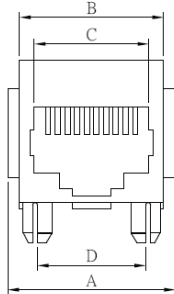

Recommended PCB Layout
(PCB TOLERANCE ±0.05)

Positions	Contacts	A	B	C	D
4P	4C	13.70	11.20	7.70	7.62
6P	2C/4C/6C	15.75	13.20	9.90	10.16
8P	8C	17.70	15.20	11.95	11.43
10P	10C	17.70	15.20	11.95	11.43

Order Information

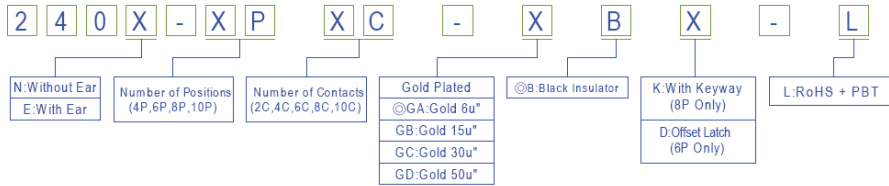

Modular Jack Top Entry H=16.4 W=16.5

Material & Finish:

Housing: Glass Fiber, PBT, UL94V-0, Black
 Contact: 0.35 mm thickness phosphor bronze,
 Gold plating over Nickel on contact area,
 Tin plating over Nickel on solder area.

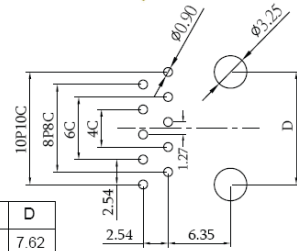
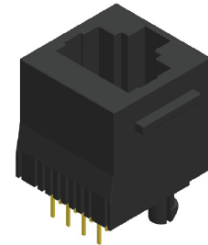
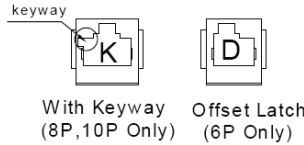
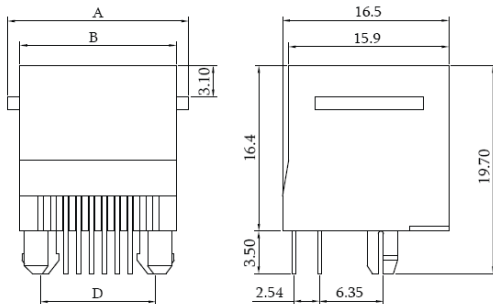
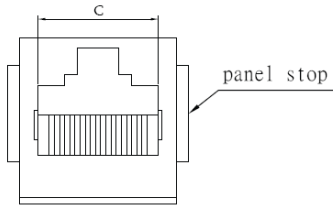

Recommended PCB Layout
(PCB TOLERANCE ±0.05)

Positions	Contacts	A	B	C	D
4P	4C	13.97	11.43	7.90	7.62
6P	2C/4C/6C	16.00	13.46	10.00	10.16
(8P)6P	4C/6C	18.03	15.49	10.00	11.43
8P	4C/6C/8C	18.03	15.49	11.90	11.43
10P	10C	18.03	15.49	11.90	11.43

Order Information

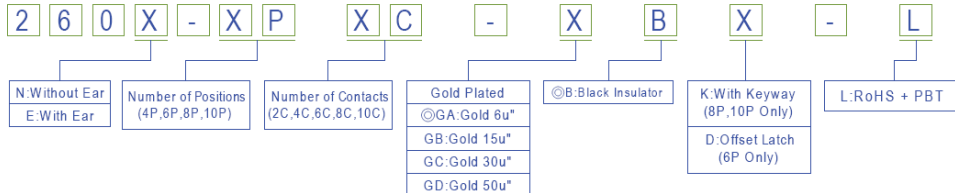

Modular Jack

