

# Audio-Video Combo Jack Series

**TOPTEK®**

HARDWARE ELECTRONIC MANUFACTURER

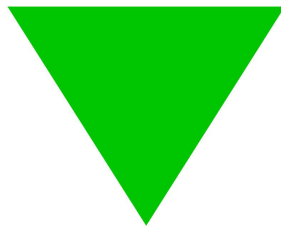

[www.toptek-co.com](http://www.toptek-co.com)

TOPTEK srl  
10015 - IVREA (TO) - ITALY  
tel. +39 0125 251 211 - fax +39 0341 367 607  
[info@toptek-co.com](mailto:info@toptek-co.com)

Contact Resistance:  $\leq 0.03 \Omega$   
 Insulation Resistance:  $\geq 100M \Omega$   
 Withstand Voltage: 500V, AC/minute  
 Temperature Range:  $-25^{\circ}\text{C} \sim +70^{\circ}\text{C}$

Insertion and Extraction Force: 3N ~ 30N (RCA Jack)  
 Insertion and Extraction Force: 4N ~ 40N (DIN (Jack))  
 Terminal Strength:  $\geq 20\text{N}$   
 Rated Load: 30V DC 0.3A      Life:  $\geq 5000$  Cycles



## R-DIN-101

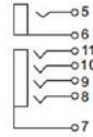
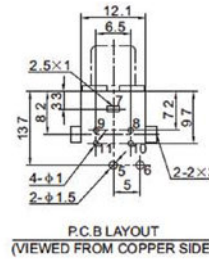
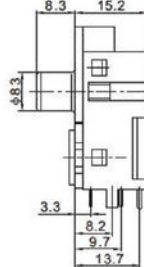
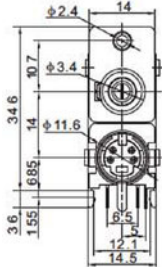

7  
\*  
47

## R-DIN-101A

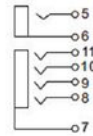
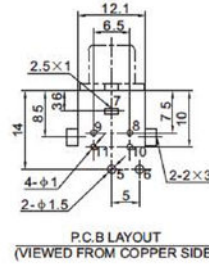
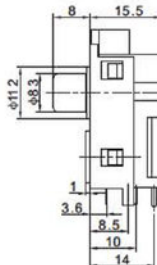
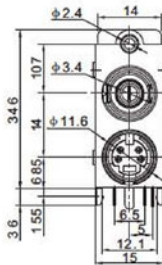

## R-DIN-101C

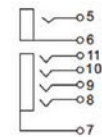
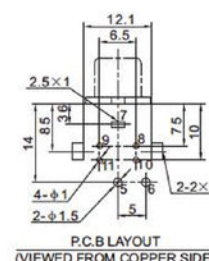
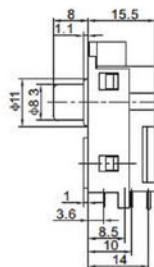
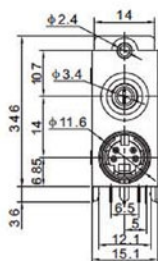

## R-DIN-101D

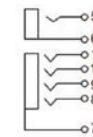
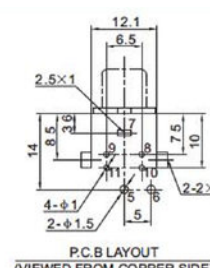
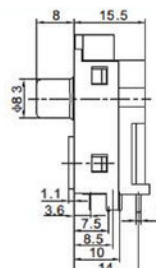
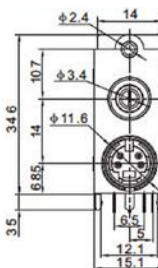

# CONNECTOR MANUFACTURERS

Contact Resistance:  $\leq 0.03 \Omega$   
 Insulation Resistance:  $\geq 100M \Omega$   
 Withstand Voltage: 500V, AC/minute  
 Temperature Range:  $-25^{\circ}\text{C} \sim +70^{\circ}\text{C}$

Insertion and Extraction Force: 3N ~ 30N (RCA Jack)  
 Insertion and Extraction Force: 4N ~ 40N (DIN (Jack))  
 Terminal Strength:  $\geq 20N$   
 Rated Load: 30V DC 0.3A  
 Life:  $\geq 5000$  Cycles

**TOPTEK**<sup>®</sup>  
 HARDWARE ELECTRONIC MANUFACTURER

www.toptek-co.com

## R-DIN-102A

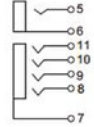
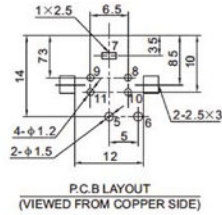
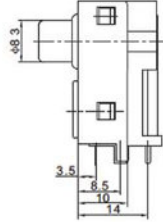
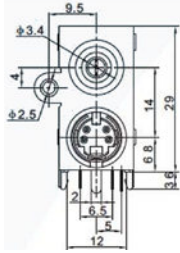

## R-DIN-103A

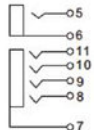
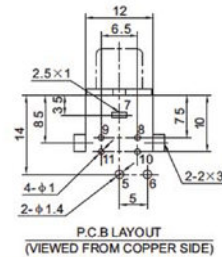
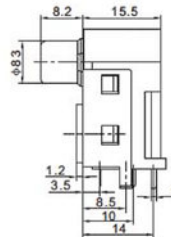
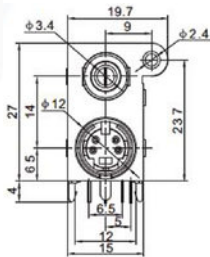

## R-DIN-104

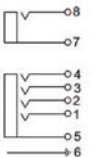
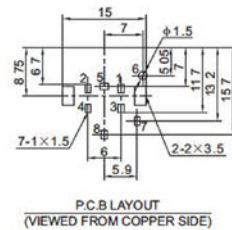
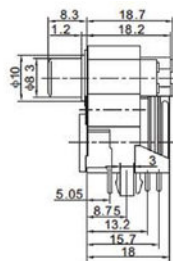
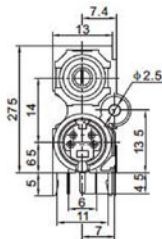

## R-DIN-104K

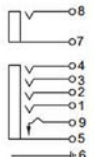
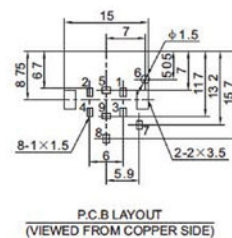
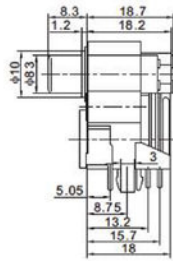
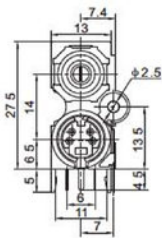

7 \* 48

A-V Combo Series



ROHS

Contact Resistance:  $\leq 0.03 \Omega$   
 Insulation Resistance:  $\geq 100M \Omega$   
 Withstand Voltage: 500V, AC/minute  
 Temperature Range:  $-25^{\circ}\text{C} \sim +70^{\circ}\text{C}$

Insertion and Extraction Force: 3N ~ 30N (RCA Jack)  
 Insertion and Extraction Force: 4N ~ 40N (DIN (Jack))  
 Terminal Strength:  $\geq 20\text{N}$   
 Rated Load: 30V DC 0.3A      Life:  $\geq 5000$  Cycles

## R-DIN-105A

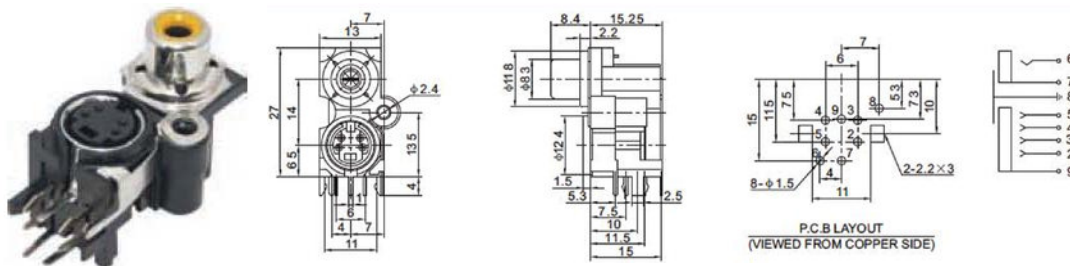

7  
\*  
49

## R-DIN-105K

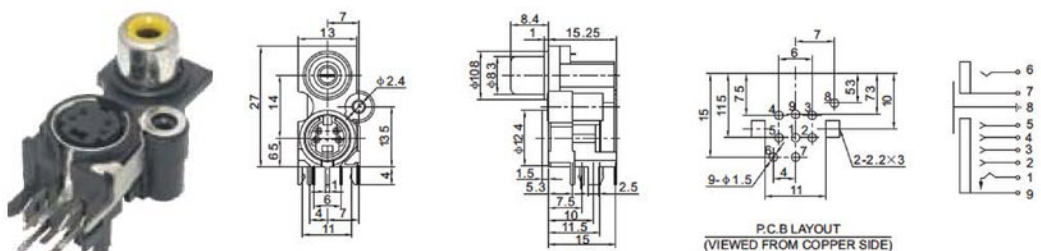

## R-DIN-105KA

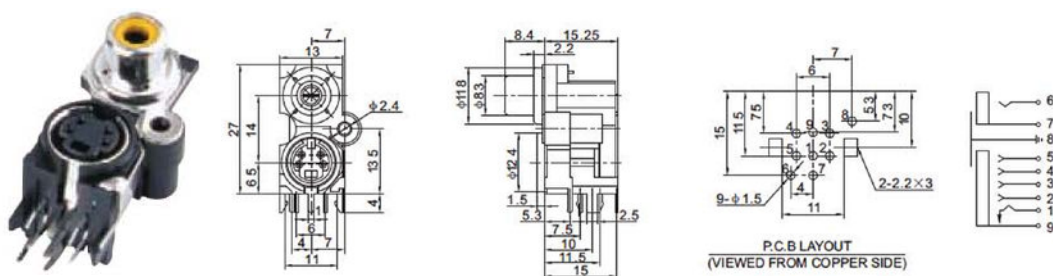

## R-DIN-106K

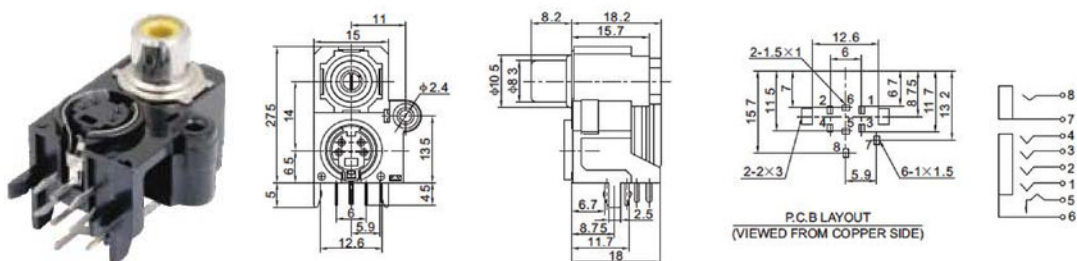

# CONNECTOR MANUFACTURERS

Contact Resistance:  $\leq 0.03 \Omega$   
 Insulation Resistance:  $\geq 100M \Omega$   
 Withstand Voltage: 500V, AC/minute  
 Temperature Range:  $-25^{\circ}\text{C} \sim +70^{\circ}\text{C}$

Insertion and Extraction Force: 3N ~ 30N (RCA Jack)  
 Insertion and Extraction Force: 4N ~ 40N (DIN Jack)  
 Terminal Strength:  $\geq 20\text{N}$   
 Rated Load: 30V DC 0.3A  
 Life:  $\geq 5000$  Cycles



## R-DIN-107A

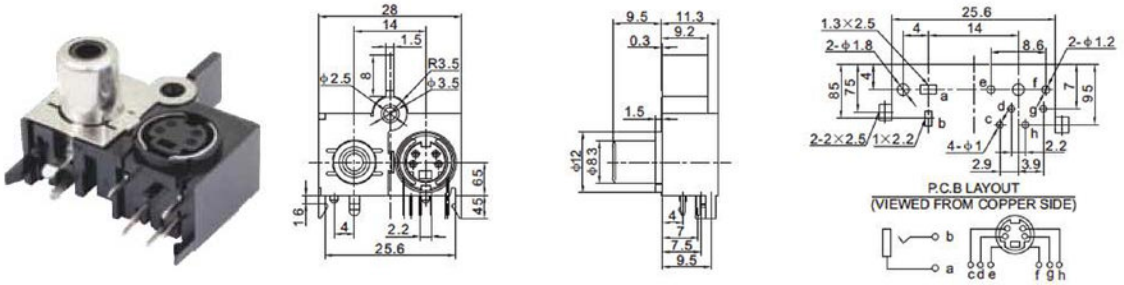

## R-DIN-301K

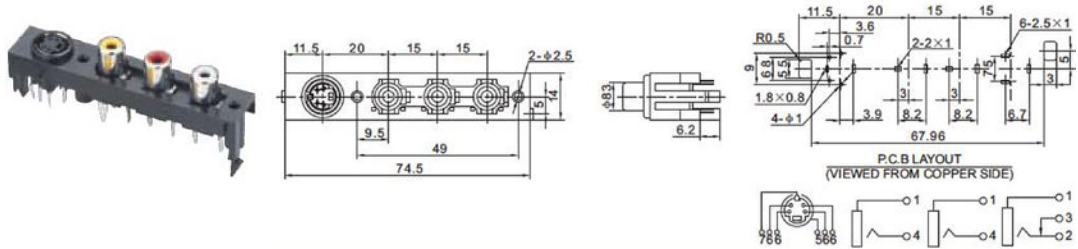

## R-DIN-301KA

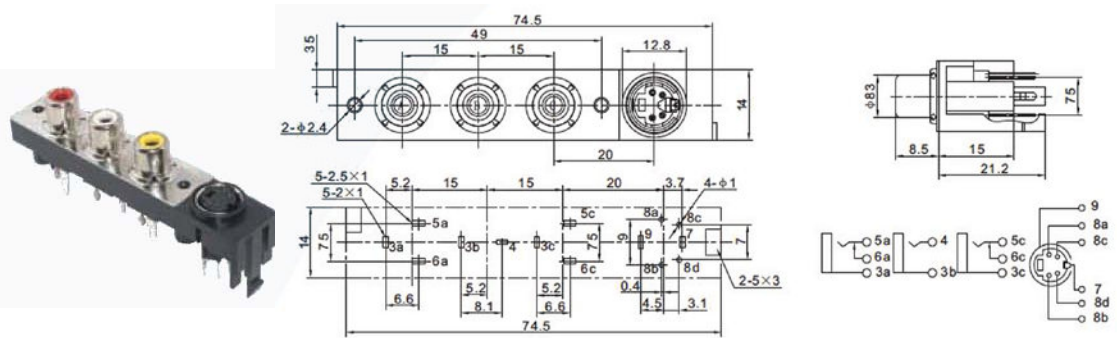

## R-DIN-302K

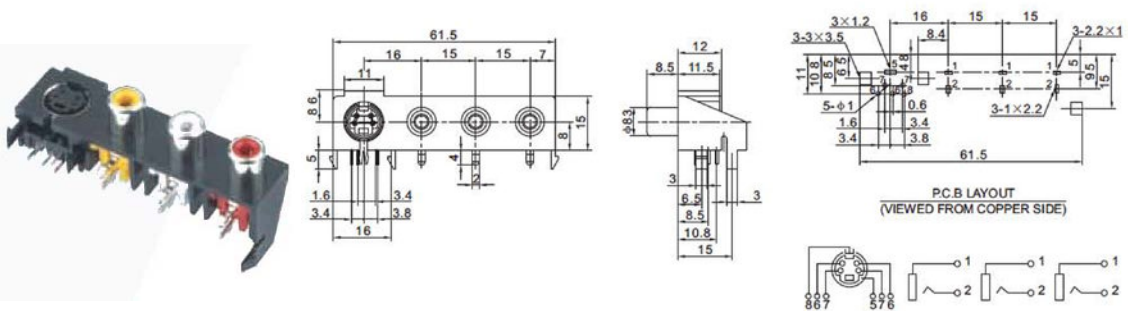

Contact Resistance:  $\leq 0.03 \Omega$   
 Insulation Resistance:  $\geq 100M \Omega$   
 Withstand Voltage: 500V, AC/minute  
 Temperature Range:  $-25^{\circ}\text{C} \sim +70^{\circ}\text{C}$

Insertion and Extraction Force: 3N ~ 30N (RCA Jack)  
 Insertion and Extraction Force: 4N ~ 40N (DIN (Jack))  
 Terminal Strength:  $\geq 20\text{N}$   
 Rated Load: 30V DC 0.3A  
 Life:  $\geq 5000$  Cycles



## R-DIN-303K

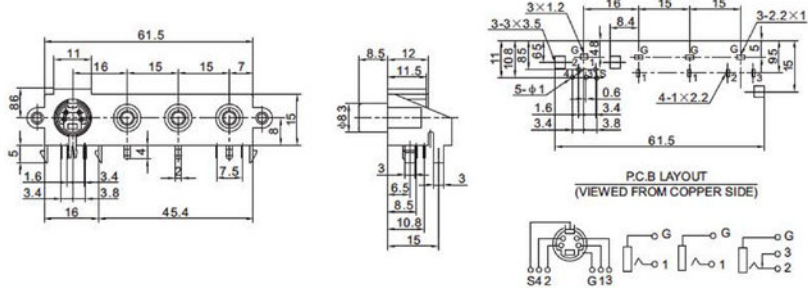

7  
\*  
51

## R-DIN-304K

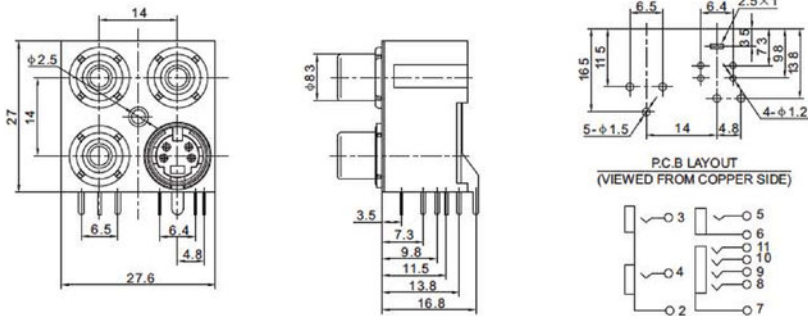

## R-DIN-305

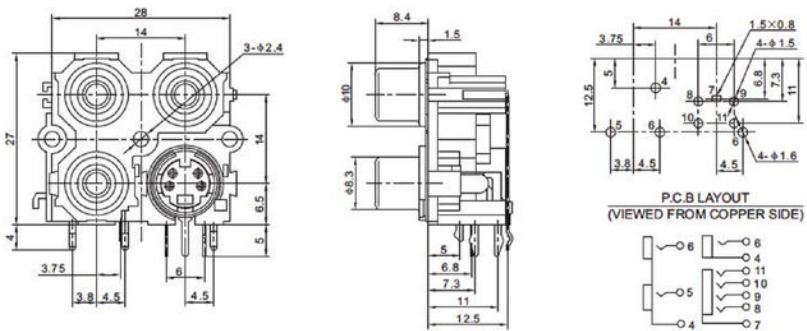

## R-DIN-306A

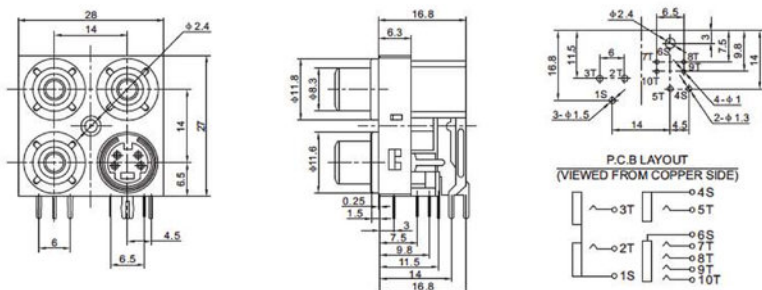

# CONNECTOR MANUFACTURERS



Contact Resistance:  $\leq 0.03 \Omega$   
 Insulation Resistance:  $\geq 100M \Omega$   
 Withstand Voltage: 500V, AC/minute  
 Temperature Range:  $-25^\circ\text{C} \sim +70^\circ\text{C}$

Insertion and Extraction Force: 3N ~ 30N (RCA Jack)  
 Insertion and Extraction Force: 4N ~ 40N (DIN (Jack))  
 Terminal Strength:  $\geq 20N$   
 Rated Load: 30V DC 0.3A      Life:  $\geq 5000$  Cycles

## R-DIN-307

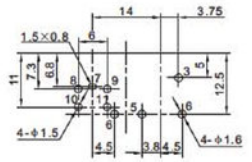
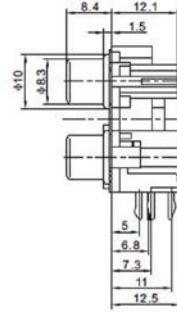
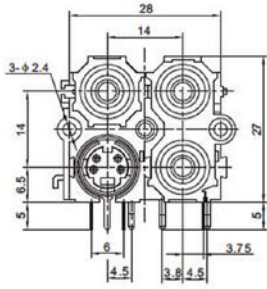

P.C.B LAYOUT (VIEWED FROM COPPER SIDE)

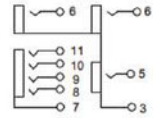

## R-DIN2-601

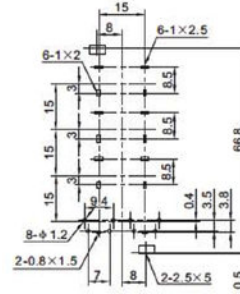
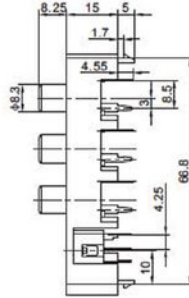
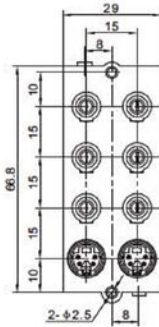

P.C.B LAYOUT (VIEWED FROM COPPER SIDE)

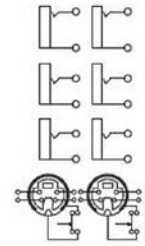

## R-DIN-701

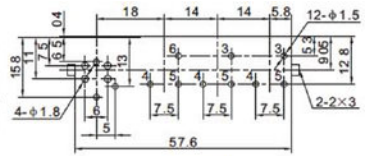
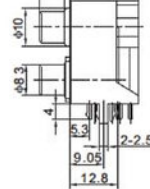
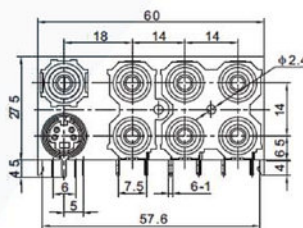

P.C.B LAYOUT (VIEWED FROM COPPER SIDE)

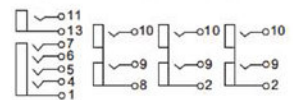

Contact Resistance:  $\leq 0.03 \Omega$   
 Insulation Resistance:  $\geq 100M \Omega$   
 Withstand Voltage: 500V, AC/minute  
 Temperature Range:  $-25^{\circ}\text{C} \sim +70^{\circ}\text{C}$

Insertion and Extraction Force: 3N ~ 30N (RCA Jack)  
 Insertion and Extraction Force: 4N ~ 40N (DIN Jack)  
 Terminal Strength:  $\geq 20\text{N}$   
 Rated Load: 30V DC 0.3A  
 Life:  $\geq 5000$  Cycles



## R-DIN-703

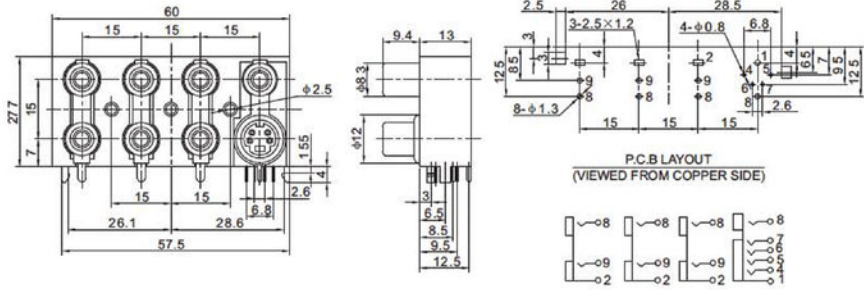

7  
\*  
53

## R-DIN3-901

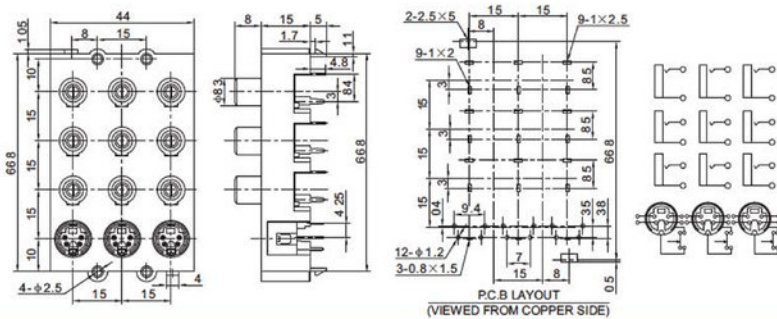

## R-DIN-1301A

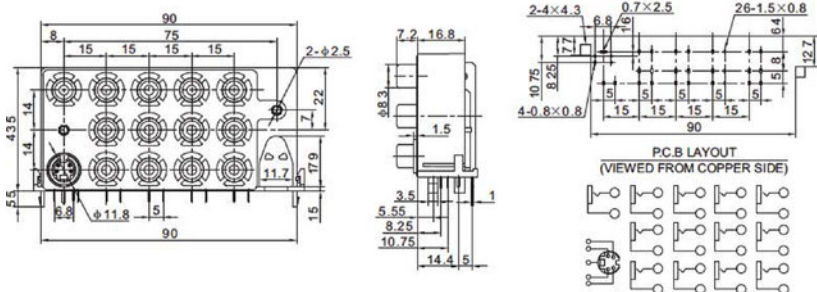



# CONNECTOR MANUFACTURERS



Contact Resistance:  $\leq 0.05 \Omega$   
 Insulation Resistance:  $\geq 100M \Omega$   
 Withstand Voltage: 500V, AC/minute  
 Temperature Range:  $-25^{\circ}\text{C} \sim +70^{\circ}\text{C}$

Insertion and Extraction Force: 5N ~ 30N (RCA Jack)  
 Insertion and Extraction Force: 11N ~ 88N (CS (Jack))  
 Rated Load: 40V AC, 0.5A (RCA Jack)  
 Rated Load: 250V AC, 3A (CS (Jack))  
 Life:  $\geq 5000$  Cycles

## R-CS-01

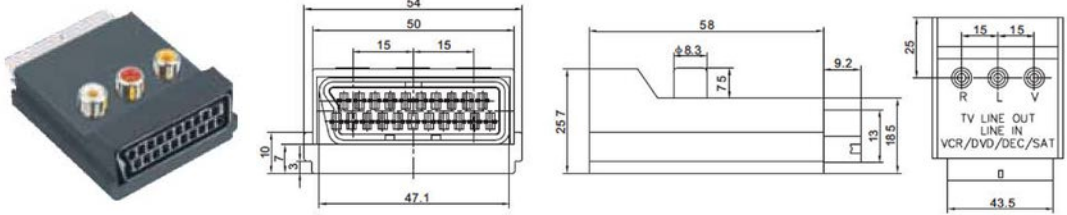

## R-CS-02

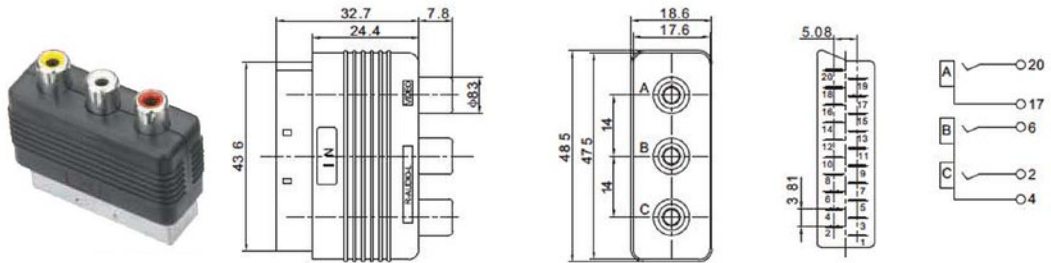

## R-CS-03

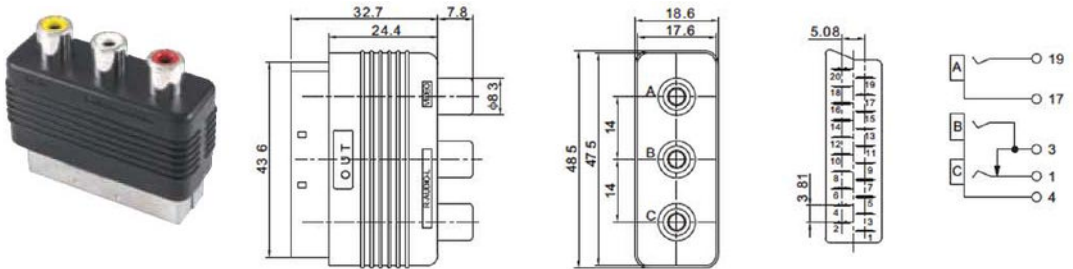

## R-CS-03A

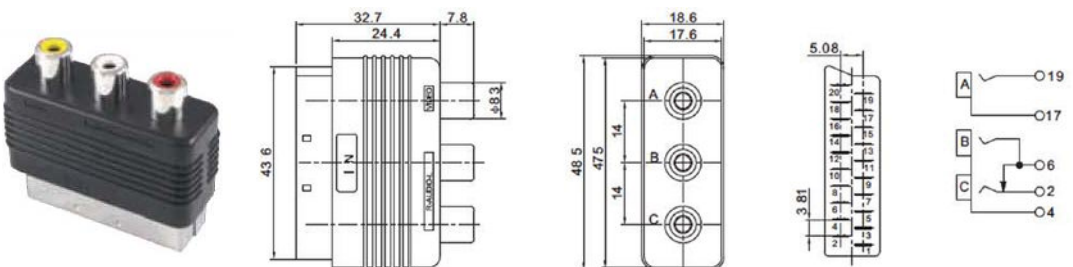

Contact Resistance:  $\leq 0.05 \Omega$   
 Insulation Resistance:  $\geq 100M \Omega$   
 Withstand Voltage: 500V, AC/minute  
 Temperature Range:  $-25^{\circ}\text{C} \sim +70^{\circ}\text{C}$

Insertion and Extraction Force: 5N ~ 30N (RCA Jack)  
 Insertion and Extraction Force: 11N ~ 88N (CS Jack)  
 Rated Load: 40V AC, 0.5A (RCA Jack)  
 Rated Load: 250V AC, 3A (CS Jack)      Life:  $\geq 5000$  Cycles



## R-CS-04

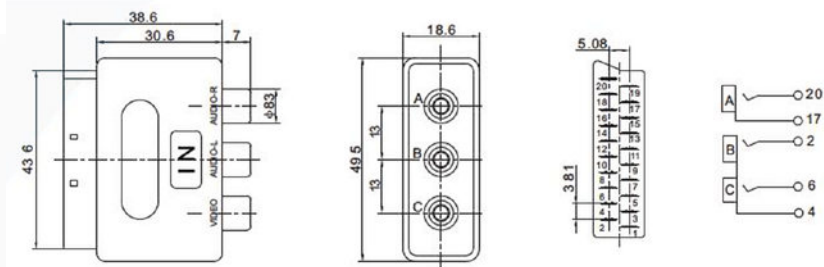

**7**  
\*  
**55**

## R-CS-04A

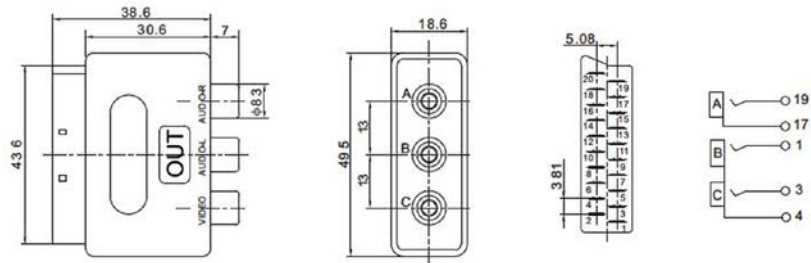

## R-CS-05

