

## 2.5mm Terminal / Housing / Wafer R/A / Straight Type

**Specifications**

Current Rating: 3A AC,DC  
Voltage Rating: 500V AC,DC  
Temperature Range: -25°C to +85°C  
Contact Resistance: 10mΩ Max  
Insulation Resistance: 500MΩ Min  
Withstanding Voltage: 1000V AC/minute  
Terminal: Brass / Tin Plated  
Material: Nylon 66, UL94V-0

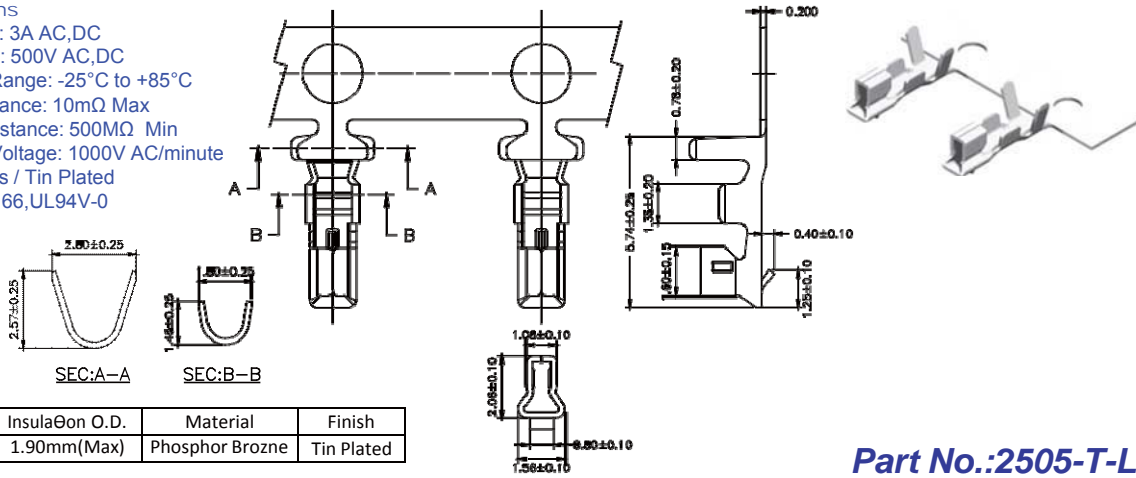

Wire Range	Insulation O.D.	Material	Finish
#22-#30	1.90mm(Max)	Phosphor Bronze	Tin Plated

**Part No.:2505-T-L**

No. of Contacts	Dimensions	
	A	B
2	2.50	7.30
3	5.00	9.80
4	7.50	12.30
5	10.00	14.80
6	12.50	17.30
7	15.00	19.80
8	17.50	22.30
9	20.00	24.80
10	22.50	27.30
11	25.00	29.80
12	27.50	32.30
13	30.00	34.80
14	32.50	37.30
15	35.00	39.80

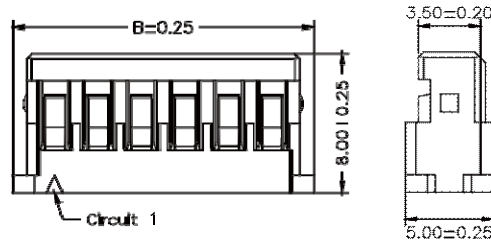
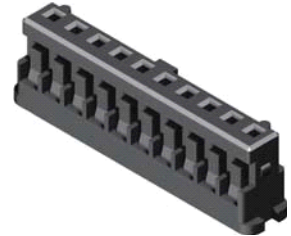
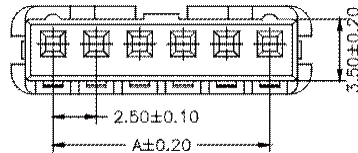

**Part No.:2508H-XXB-L**

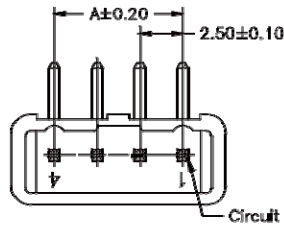

No. of Contacts	Dimensions	
	A	B
2	2.50	7.50
3	5.00	10.00
4	7.50	12.50
5	10.00	15.00
6	12.50	17.50
7	15.00	20.00
8	17.50	22.50
9	20.00	25.00
10	22.50	27.50
11	25.00	30.00
12	27.50	32.50
13	30.00	35.00
14	32.50	37.50
15	35.00	40.00

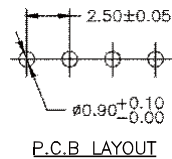
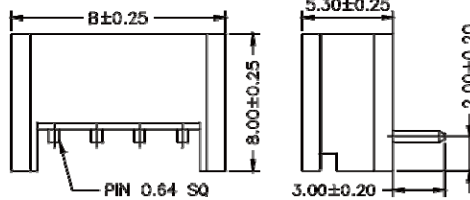

**Part No.:2508R-XXTB-L**

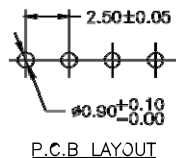
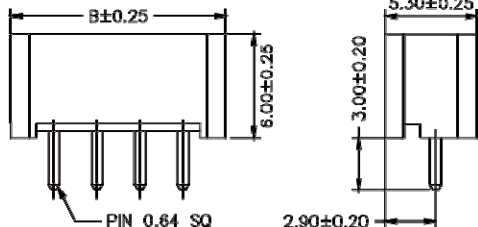
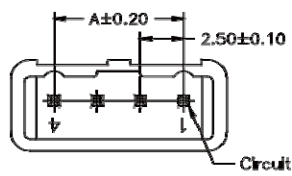

**Part No.:2508S-XXTB-L**