

SQUARE SNAP BUSHING

- ◆ MATERIAL: NYLON 66 (UL)
- ◆ FLAME CLASS: 94V-2/94V-0
- ◆ COLOR: NATURAL/BLACK
- ◆ UNIT: mm

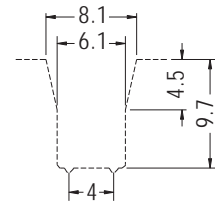
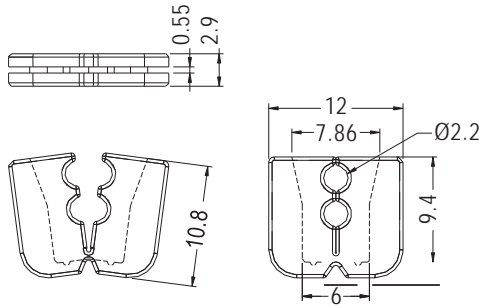

MOUNTING HOLE THICKNESS 0.6

PART NO	PACKAGE
SQG-10	1000

SQUARE SNAP BUSHING



- ◆ MATERIAL: NYLON 66 (UL)
- ◆ FLAME CLASS: 94V-2/94V-0
- ◆ COLOR: NATURAL/BLACK
- ◆ UNIT: mm

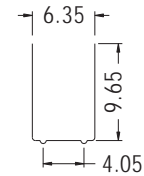
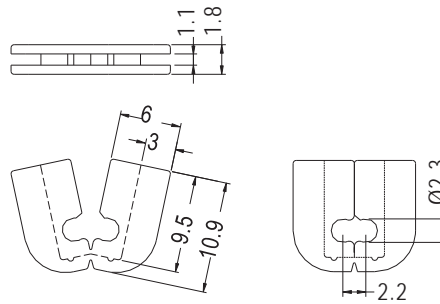
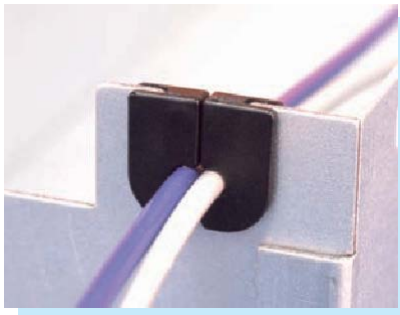

MOUNTING HOLE THICKNESS 0.8-1.0

PART NO	PACKAGE
SQG-12	1000

SQUARE SNAP BUSHING

- ◆ MATERIAL: NYLON 66 (UL)
- ◆ FLAME CLASS: 94V-2/94V-0
- ◆ COLOR: NATURAL/BLACK
- ◆ UNIT: mm

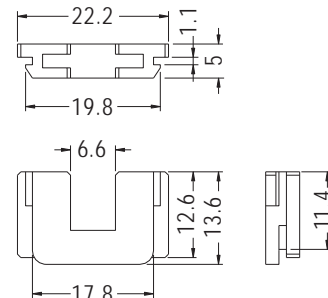
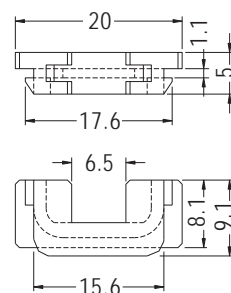

PART NO	PACKAGE
SQN-1	1000

PART NO	PACKAGE
SQN-2	1000

