

# F.B.T CLIP

- ◆ MATERIAL: NYLON 66 (UL)
- ◆ FLAME CLASS: 94V-2/94V-0
- ◆ COLOR: NATURAL
- ◆ UNIT: mm

  
 E217732  
 UL1565

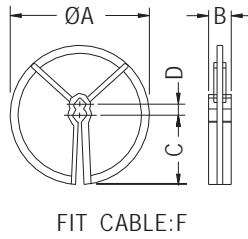
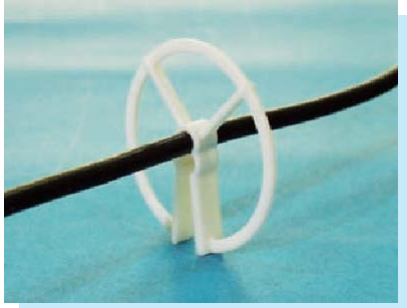

PARTNO	A	B	C	D	F	PACKAGE
FBT-1	49.5	7.8	22.0	5.0	4.5~5.3	100
FBT-2	49.2	7.8	22.0	5.0	3.5~4.5	
FBT-3	50.2	7.4	23.0	5.0	2.5~3.5	
FBT-4	49.5	8.0	22.5	4.6	4.0~4.5 or 5.0~5.5	
FBT-5	49.2	8.0	22.0	4.7	3.7~4.2 or 4.5~5.2	

# FIBER CABLE HOUSING

- ◆ MATERIAL: NYLON 66 (UL)
- ◆ FLAME CLASS: 94V-2
- ◆ COLOR: NATURAL
- ◆ UNIT: mm

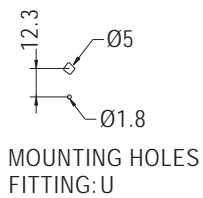
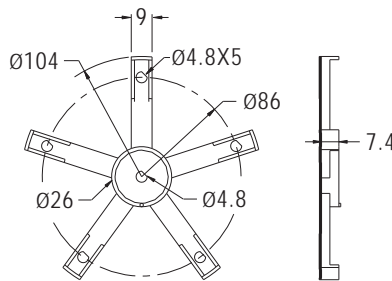
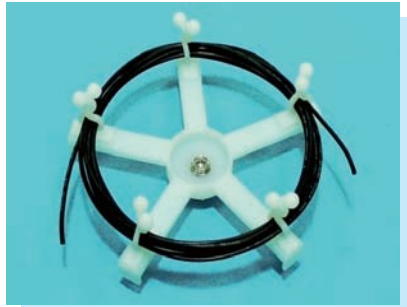

PARTNO	U	PACKAGE
FSB-1	Screw	50
FSB-1A	Adhesive	

# FIBER CABLE HOUSING

- ◆ MATERIAL: NYLON 66 (UL)
- ◆ FLAME CLASS: 94V-2
- ◆ COLOR: NATURAL
- ◆ UNIT: mm

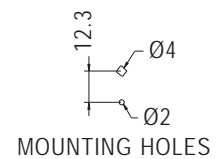
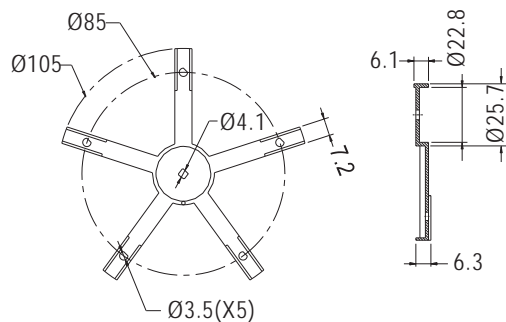

PARTNO	PACKAGE
FSB-2	50