

PLASTIC PARTS for PCB

SPACER SUPPORT ROUND SPACER THREADED SPACER

1

TOPTTEK®

HARDWARE ELECTRONIC MANUFACTURER

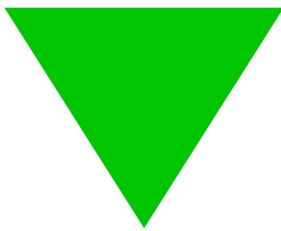

www.toptek-co.com

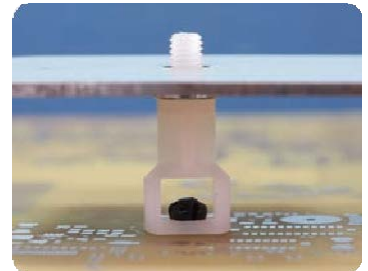
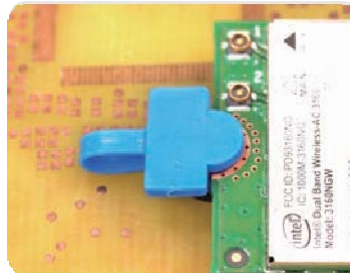

info@toptek-co.com

www.toptek-co.com

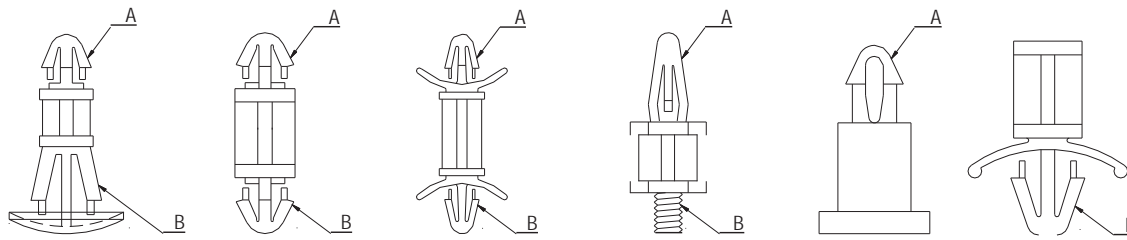

1

PART NO.	A	B	PAGE	NOTE
LIJ-4		Ø2.5	1-73	
LBS-		Ø3.0	1-48	
MSA-		Ø3.0	1-50	
TCBA-		Ø3.0	1-54	
LIO-		Ø3.0	1-73	
LIO-8		Ø3.0	1-73	
MSPE-7		Ø3.2	1-30	
LCUA-11		Ø3.4	1-91	
EDC-		Ø3.5	1-3	
LASE-		Ø3.5	1-50	
SSUL-8		Ø3.5	1-80	
LIES-1		Ø3.8	1-81	
RAMA-		Ø4.0	1-1	
RAMC-		Ø4.0	1-3	
LASB-3.7		Ø4.0	1-48	
LASF-18		Ø4.0	1-50	
TCEB3-	THREAD	Ø4.1	1-69	M3X0.5P
TCEB4-	THREAD	Ø4.1	1-69	M4X0.7P
TCEB632-	THREAD	Ø4.1	1-69	6-32 UNC
LCU-18		Ø4.3	1-93	
LASD-8.3		Ø4.5	1-48	
RAD-		Ø4.8	1-1	
RAMD-15.5		Ø4.8	1-3	
LASY-		Ø4.8	1-49	
LAS-		Ø4.8	1-49	
ULCF-		Ø4.8	1-82	
WLCF-		Ø4.8	1-82	
LCDS3-	THREAD	Ø4.8	1-44	M3X0.5P
LCDS4-	THREAD	Ø4.8	1-44	M4X0.7P
LASA-9.5		Ø4.8~5.0	1-49	
CUS-5		Ø5.0	1-79	
RAM-13.5L		Ø5.5	1-1	
RAM-		Ø5.5	1-2	
RAML-		Ø5.5	1-2	
RAS-		Ø5.5	1-2	
KVLM3-		5.5X5.5	1-60	M3X0.5P
RAMB-9		Ø5.6	1-4	
LDD-		Ø6.0	1-82	
PAA-11		6.0X7.0	1-72	
MASD-	Ø1.5		1-51	
MASS-	Ø1.5		1-51	
MASSD-	Ø1.5	Ø1.5	1-15	

PART NO.	A	B	PAGE	NOTE
MAEB-3.2	Ø1.5	Ø3.0	1-22	
LCMB-8	Ø1.5	Ø3.0	1-23	
MADSA-3	Ø1.6	Ø1.6	1-15	
MADS-	Ø1.6	Ø2.0	1-15	
MAS-9	Ø1.6	Ø2.0	1-15	
MAD1.7-98	Ø1.7	Ø1.7	1-16	
MA-	Ø2.0		1-51	
MA-XXDL	Ø2.0		1-52	
MAB-4	Ø2.0		1-53	
MAL-8	Ø2.0		1-53	
MAST-	Ø2.0		1-55	
MASL-5.4	Ø2.0		1-55	
MS-	Ø2.0		1-56	
ISS-	Ø2.0		1-83	DOUBLE ADHESIVE TAPE
MAD1-	Ø2.0	Ø2.0	1-16	
MAD1.2-6	Ø2.0	Ø2.0	1-16	
MADX-9.5	Ø2.0	Ø2.0	1-16	
MADB-	Ø2.0	Ø2.0	1-17	
MAD-	Ø2.0	Ø2.0	1-17	
MADG-5.4	Ø2.0	Ø2.0	1-38	
MAMDA-	Ø2.0	Ø2.5	1-17	
LCMA-	Ø2.0	Ø3.0~3.2	1-41	
RCAB-	Ø2.0	Ø4.0	1-14	
MCSH-7.2	2.0X3.0		1-59	
PCLS-25	Ø2.2		1-56	
MSB-2.8	Ø2.3		1-56	
ULCBA-5	Ø2.35	Ø4.0	1-88	
MAMS-	Ø2.5		1-52	
MAM-	Ø2.5		1-52	
MAMS-7.5	Ø2.5		1-53	
MAM-	Ø2.5		1-53	
MSM-2.5	Ø2.5		1-56	
MAE2.5-6.5	Ø2.5		1-57	
MAE2.5-6.5T	Ø2.5		1-57	M2X0.4P
GSS-	Ø2.5		1-83	DOUBLE ADHESIVE TAPE
ULCI-11	Ø2.5		1-86	
ULCIJ-4	Ø2.5		1-86	
SCBS632-	Ø2.5	THREAD	1-132	6-32 UNC
MADA-18S	Ø2.5	Ø2.5	1-18	
MADAA-14	Ø2.5	Ø2.5	1-18	
MAMDL-9	Ø2.5	Ø2.5	1-18	
MAMDF-7	Ø2.5	Ø2.5	1-18	



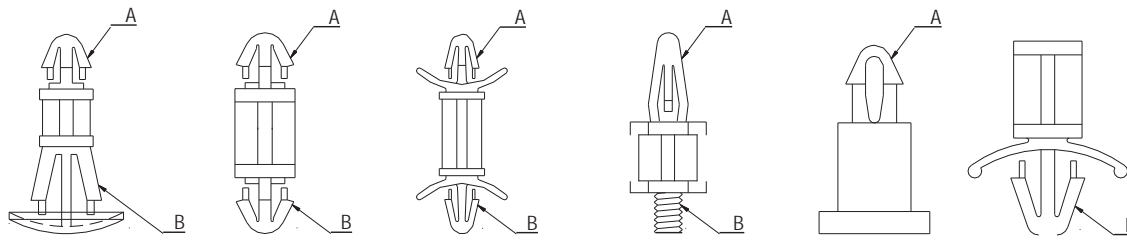

PART NO.	A	B	PAGE	NOTE
MADA-	Ø2.5	Ø2.5	1-19	
MADM-	Ø2.5	Ø2.5	1-19	
MADE-2.8	Ø2.5	Ø2.5	1-20	
MAC-	Ø2.5	Ø2.5	1-20	
MAHC-14.3	Ø2.5	Ø2.5	1-20	
MADMK-5	Ø2.5	Ø2.5	1-23	
LCMC-7	Ø2.5	Ø3.0	1-23	
LCMD-	Ø2.5	Ø3.0~3.2	1-41	
RCAC-	Ø2.5	Ø4.0	1-14	
MAEE-4.5	Ø2.5	Ø4.0	1-22	
MSPA-1.6	Ø2.6	Ø2.8	1-33	
LCUE-3.3	Ø2.6	Ø3.2	1-89	
MAMA-3.5	Ø2.7		1-52	
MAL-34	Ø3.0		1-53	
DCC-	Ø3.0		1-54	
DCE-4	Ø3.0		1-54	
DCC-20S	Ø3.0		1-54	
MAE-	Ø3.0		1-57	
MAE-XXT	Ø3.0		1-57	M3X0.5P
MAE-7-440	Ø3.0		1-58	
MAE-7-440T	Ø3.0		1-58	4-40 UNC
DCB-	Ø3.0		1-60	
DCBA-3.5	Ø3.0		1-60	
SS1-	Ø3.0		1-77	M2 SCREW
SS3-7(1.3)	Ø3.0		1-77	M2 SCREW
BSS-	Ø3.0		1-84	DOUBLE ADHESIVE TAPE
CSSA-2	Ø3.0		1-84	DOUBLE ADHESIVE TAPE
CSS-	Ø3.0		1-84	DOUBLE ADHESIVE TAPE
SCBA-	Ø3.0	THREAD	1-132	M3X0.5P
MSPA3-9.7	Ø3.0	THREAD	1-133	M3X0.5P
MADL-27.8	Ø3.0	Ø3.0	1-20	
MAMDC-12	Ø3.0	Ø3.0	1-21	
MSPC3-	Ø3.0	Ø3.0	1-24	
MSPC3-3.2L	Ø3.0	Ø3.0	1-24	
MSPF3-	Ø3.0	Ø3.0	1-24	
SSDU1-3.5	Ø3.0	Ø3.0	1-30	
LCV-	Ø3.0	Ø3.0	1-31	
LCVA-	Ø3.0	Ø3.0	1-31	
LCVU-	Ø3.0	Ø3.0	1-31	
LCJ-	Ø3.0	Ø3.0	1-31	
LMSA-6	Ø3.0	Ø3.0	1-34	
LCGA-	Ø3.0	Ø3.0	1-35	

PART NO.	A	B	PAGE	NOTE
LCF-	Ø3.0	Ø3.0	1-35	
CBSA-13	Ø3.0	Ø3.0	1-35	
LCA-	Ø3.0	Ø3.0	1-38	
LCG-	Ø3.0	Ø3.0	1-42	
LCFO-	Ø3.0	Ø3.5	1-35	
RCI-2.6	Ø3.0	Ø4.0	1-4	
RCO-2.5	Ø3.0	Ø4.0	1-4	
RCO-2.5L	Ø3.0	Ø4.0	1-4	
RCA-	Ø3.0	Ø4.0	1-5	
MAEA-35M	Ø3.0	Ø4.0	1-22	
LCX-31	Ø3.0	Ø4.0	1-32	
LCH-	Ø3.0	Ø4.0	1-39	
RCC-	Ø3.0	Ø4.8	1-5	
MAEA-	Ø3.0	Ø4.8	1-22	
LCBT-	Ø3.0	Ø4.8	1-42	
KLCBS-	Ø3.0	Ø4.8	1-43	
RCG-	Ø3.0	Ø5.5	1-6	
MADD-2	Ø3.1	Ø3.0	1-20	
JSS-	Ø3.2		1-85	DOUBLE ADHESIVE TAPE
LCPL-6.4	Ø3.2	Ø2.0	1-34	
LCSE-3.2	Ø3.2	Ø3.0~3.2	1-45	
MSPB32-64	Ø3.2	Ø3.2	1-25	
MSP3-	Ø3.2	Ø3.2	1-25	
MSPS3-	Ø3.2	Ø3.2	1-26	
DMSB-	Ø3.2	Ø3.2	1-26	
MSPL-11	Ø3.2	Ø3.2	1-26	
DMSS-	Ø3.2	Ø3.2	1-27	
MSPMA-12	Ø3.2	Ø3.2	1-27	
LMSP-	Ø3.2	Ø3.2	1-34	
LCUAC-	Ø3.2	3.2X4.8	1-91	
RCMB-2.8	Ø3.2	Ø4.0	1-6	
LCUAD-1	Ø3.2	Ø4.1	1-91	
RCBS-	Ø3.2	Ø4.8	1-9	
RCV-11.1	Ø3.2	Ø4.8	1-9	
RCW-	Ø3.2	Ø4.8	1-9	
ULCD-7.8	Ø3.3		1-86	M3X0.5P
MSPH-7.5	Ø3.3	Ø3.2	1-27	
MSPD-	Ø3.3	3.2X4.8	1-27	
ULCH-	Ø3.3	3.2X4.8	1-87	M2.5
ULCSA-	Ø3.3	3.2X4.8	1-88	
MSPF3.3-8	Ø3.3	Ø3.3	1-25	
LCOA-28.8	Ø3.3	Ø3.3	1-34	

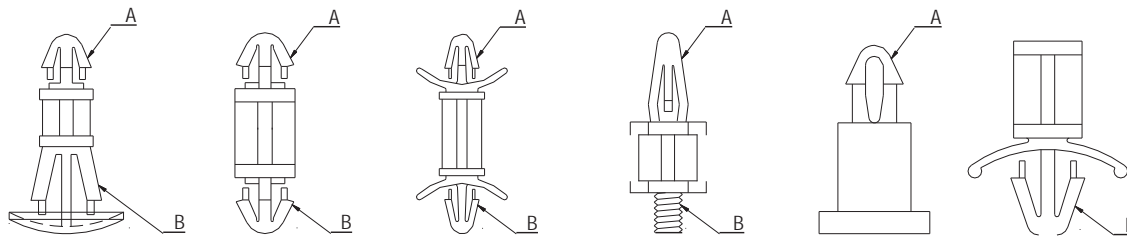

PART NO.	A	B	PAGE	NOTE
KEMS-11.3	Ø3.3	5.5X5.5	1-92	
ULCBA-7.8	Ø3.4	Ø4.8	1-89	
MCM-	Ø3.5		1-55	
PDC-	Ø3.5		1-61	
MCN-10	Ø3.5		1-62	
FSS-	Ø3.5		1-84	DOUBLE ADHESIVE TAPE
FSL-25	Ø3.5		1-85	DOUBLE ADHESIVE TAPE
SCBB-3	Ø3.5	THREAD	1-132	M3X0.5P
MAFA-6	Ø3.5	Ø3.5	1-21	
MAD3.5-12	Ø3.5	Ø3.5	1-21	
MDLS-4.5	Ø3.5	Ø3.5	1-21	
MAF-	Ø3.5	Ø3.5	1-22	
MAMDD-6	Ø3.5	Ø3.5	1-23	
LCI-	Ø3.5	Ø3.5	1-32	
LDE-33	Ø3.5	Ø3.5	1-32	
LCO-	Ø3.5	Ø3.5	1-36	
CBCS-14	Ø3.5	Ø3.5	1-36	
LCD-	Ø3.5	Ø3.5	1-36	
CBSS-	Ø3.5	Ø3.5	1-39	
LCPA-8.2	Ø3.5	Ø4.0	1-46	
LCBU-	Ø3.5	Ø4.8	1-42	
KLCBM-	Ø3.5	Ø4.8	1-43	
RCT-	Ø3.5	Ø4.8~5.0	1-12	
RCH-	Ø3.5	Ø5.5	1-6	
RCTA-4.5	Ø3.5	Ø5.5	1-12	
UCBS-5A	Ø3.8	Ø4.8	1-47	
MSP-15.9S	Ø3.9	Ø3.9	1-57	
MSMA-3.5	Ø3.9		1-28	
MSPG3-	Ø3.9~4.0	THREAD	1-133	M3X0.5P
MSPG4-	Ø3.9~4.0	THREAD	1-133	M4X0.7P
MSPS-	Ø3.9~4.0	THREAD	1-133	6-32 UNC
MCO-16	Ø4.0		1-55	
MAE4D-6	Ø4.0		1-58	
MAE4D-6T	Ø4.0		1-58	M3X0.5P
MAE4-	Ø4.0		1-58	
MAE4-XXT	Ø4.0		1-58	M4X0.7P
MAE43-	Ø4.0		1-59	
MAE43-XXT	Ø4.0		1-59	M3X0.5P
MAE43-4LT	Ø4.0		1-59	M3X0.5P
MCI-4.7	Ø4.0		1-59	
MC-	Ø4.0		1-61	
MCE-1.9	Ø4.0		1-62	

PART NO.	A	B	PAGE	NOTE
MCEA-1.9	Ø4.0		1-62	
MCH-	Ø4.0		1-62	
ACBR-6	Ø4.0		1-63	
ACB-	Ø4.0		1-63	
MCB-6	Ø4.0		1-64	
TCBS-	Ø4.0		1-65	M3 SCREW
TCBS-18	Ø4.0		1-65	M3 SCREW
TCBT-3.6	Ø4.0		1-65	
TCBT-7	Ø4.0		1-65	4-40 UNC
TCBT-	Ø4.0		1-65	M3 SCREW
TCBT-16	Ø4.0		1-65	4-40 UNC
MBS-	Ø4.0		1-66	
BS-	Ø4.0		1-67	
BS-10-1	Ø4.0		1-67	M3.5-4.0 SCREW
BSB-6	Ø4.0		1-67	
BSCL-9.5	Ø4.0		1-68	
SRLCB-	Ø4.0		1-68	
BSCB-	Ø4.0		1-70	M3X0.5P
BSCB-20	Ø4.0		1-70	M3X0.5P
BSCB4-10	Ø4.0		1-70	M4X0.7P
BSC632-	Ø4.0		1-70	6-32 UNC
BSCM4-	Ø4.0		1-71	M4X0.7P
BSD632-	Ø4.0		1-71	6-32 UNC
BSDM4-	Ø4.0		1-71	M4X0.7P
SS2-	Ø4.0		1-77	M2.6 SCREW
SS2-2.5U	Ø4.0		1-77	M2 SCREW
SOR-2	Ø4.0		1-80	
ASS-	Ø4.0		1-85	DOUBLE ADHESIVE TAPE
ULCC-	Ø4.0		1-87	M3 SCREW
LCBL-8	Ø4.0		1-93	
MSPS-2S	Ø4.0	THREAD	1-133	6-32 UNC
MSPS-3	Ø4.0	THREAD	1-133	6-32 UNC
MSPS-13	Ø4.0	THREAD	1-133	6-32 UNC
SCB-	Ø4.0	THREAD	1-134	6-32 UNC
SCB-6SM3	Ø4.0	THREAD	1-134	M3X0.5P
SCB4-	Ø4.0	THREAD	1-134	M4X0.7P
SCB832-159	Ø4.0	THREAD	1-135	8-32 UNC
LCBA-	Ø4.0	2.7X7.2	1-44	
MSP-	Ø4.0	Ø4.0	1-28	
DMSPS-	Ø4.0	Ø4.0	1-28	
DMSP-	Ø4.0	Ø4.0	1-28	
MSPM-	Ø4.0	Ø4.0	1-29	

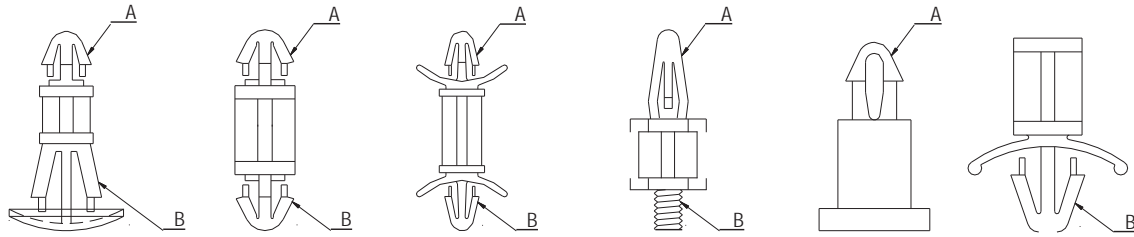

PART NO.	A	B	PAGE	NOTE
MSP1-	Ø4.0	Ø4.0	1-29	
DMSA-9	Ø4.0	Ø4.0	1-30	
LCK-1	Ø4.0	Ø4.0	1-32	
LCC-	Ø4.0	Ø4.0	1-33	
LCFB-8	Ø4.0	Ø4.0	1-36	
LCEO-	Ø4.0	Ø4.0	1-37	
LCBJ-9	Ø4.0	Ø4.0	1-37	
LCL-3.2	Ø4.0	Ø4.0	1-38	6-32 UNC
CBLSS-	Ø4.0	Ø4.0	1-39	
LCGB-17.5	Ø4.0	Ø4.0	1-43	
WBHB-1.8	Ø4.0	Ø4.0	1-72	
ULCE-9	Ø4.0	Ø4.0	1-90	
MSPR-3	Ø4.0	Ø4.0	1-95	
ULCH-1	Ø4.0	4.0X6.8	1-87	
LCT-9	Ø4.0	Ø4.5	1-37	
DRCB-18	Ø4.0	Ø4.5~5.0	1-14	
LCSA-	Ø4.0	Ø4.75	1-45	
RCD-	Ø4.0	Ø4.8	1-7	
MSPK45-	Ø4.0	Ø4.8	1-29	
LCBM-	Ø4.0	Ø4.8	1-33	
LCBZ-	Ø4.0	Ø4.8	1-37	
LCB-	Ø4.0	Ø4.8	1-39	
CBS-	Ø4.0	Ø4.8	1-40	
LCBS-	Ø4.0	Ø4.8	1-40	
VCBS-	Ø4.0	Ø4.8	1-40	
VCBSL-	Ø4.0	Ø4.8	1-41	
LCBC-8	Ø4.0	Ø4.8	1-42	
KLCBL-	Ø4.0	Ø4.8	1-43	
HLCS-	Ø4.0	Ø4.8	1-45	
LCSLR-9.5	Ø4.0	Ø4.8	1-45	
LCS-	Ø4.0	Ø4.8	1-46	
LCSD-	Ø4.0	Ø4.8	1-46	
LCSL-4.8	Ø4.0	Ø4.8	1-46	
LCP-	Ø4.0	Ø4.8	1-46	
LCY-4.8	Ø4.0	Ø4.8	1-47	
UCBS-	Ø4.0	Ø4.8	1-47	
ULCB-	Ø4.0	Ø4.8	1-90	
RCS-	Ø4.0	Ø5.0	1-5	
RCWA-	Ø4.0	Ø5.4	1-9	
PCBS-6.4	Ø4.0	Ø5.4	1-11	
RCTL-	Ø4.0	Ø5.4	1-12	
RCJ-	Ø4.0	Ø5.4	1-13	

PART NO.	A	B	PAGE	NOTE
UCBSL-	Ø4.0	Ø5.4	1-47	
RCI-5	Ø4.0	Ø5.5	1-7	
RCMA-3	Ø4.0	Ø5.5	1-7	
RCB-	Ø4.0	Ø5.5	1-7	
RCBL-6	Ø4.0	Ø5.5	1-8	
RCM-	Ø4.0	Ø5.5	1-8	
RCR-12.7	Ø4.0	Ø5.5	1-10	
PCBT-	Ø4.0	Ø5.5	1-10	
PCBS-3	Ø4.0	Ø5.5	1-11	
PCBS-	Ø4.0	Ø5.5	1-11	
RBT-	Ø4.0	Ø5.5	1-13	
RBS-	Ø4.0	Ø5.5	1-13	
KEML-4	Ø4.0	5.5X5.5	1-93	
RCF-	Ø4.0	Ø6.0	1-8	
PCBTA-4.8	Ø4.0	Ø6.0	1-10	
RCFL-	Ø4.0	Ø6.0	1-11	
PCC-6	Ø4.0	6.0X7.0	1-72	
PCC-11	Ø4.0	6.0X7.0	1-72	
RCFA-7	Ø4.0	6.3X6.3	1-11	
RCRA-9.5	Ø4.0	Ø6.35	1-10	
KES-15	Ø4.0	6.5X7.0	1-89	
WBH-	Ø4.0	Ø7.9	1-71	
SRLA-31.5	Ø4.1	Ø4.75~4.8	1-68	
BSB-8.5	Ø4.2		1-67	
MBC-11	Ø4.5		1-64	
TCBT-19	Ø4.5		1-66	M3 SCREW
MTD-11	Ø4.5		1-66	
MBD-10	Ø4.5~4.8		1-64	
MCL-	Ø4.8		1-62	
SS-	Ø4.8		1-78	M3 SCREW
SSA-12.7	Ø4.8		1-78	
MSPK4.8-	Ø4.8	Ø4.8	1-29	
LCBY-	Ø4.8	Ø4.8	1-38	
LCBYR-4.8	Ø4.8	Ø4.8	1-38	
MAFB5-	Ø5.0	Ø5.0	1-22	
SSDU-	Ø5.2	Ø5.2	1-30	
SOR-1	Ø5.5		1-80	
SOR-3	Ø5.5		1-80	
SSA4-5.5	Ø5.8		1-78	M3.5ORM4SCREW
SS4-	Ø5.9		1-79	
SSU4-6.3	Ø5.9		1-79	
SS3.5-	Ø5.9		1-79	M3.5 SCREW



SPACERSUPPORT

- ◆ MATERIAL:NYLON 66 (UL)
- ◆ FLAME CLASS:94V-2/94V-0
- ◆ COLOR:NATURAL/BLACK
- ◆ UNIT:mm

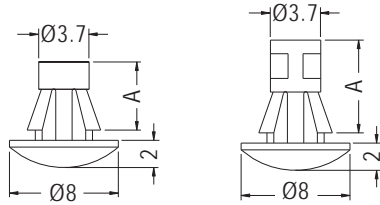

CHASSIS Ø4.0
THICKNESS 0.8-1.6

CHASSIS Ø4.0
THICKNESS 0.8-1.6

FOR RAMA-3,
RAMA-4.5,
RAMA-5.5

PART NO	A	PACKAGE
RAMA-3	3.2	1000
RAMA-4.5	4.5	
RAMA-5.5	5.5	
RAMA-6.4	6.4	
RAMA-7.5	7.5	
RAMA-9.5	9.5	
RAMA-11.1	11.1	
RAMA-12.7	12.7	

SPACER SUPPORT

- ◆ MATERIAL:NYLON 66 (UL)
- ◆ FLAME CLASS:94V-2/94V-0
- ◆ COLOR:NATURAL/BLACK
- ◆ UNIT:mm

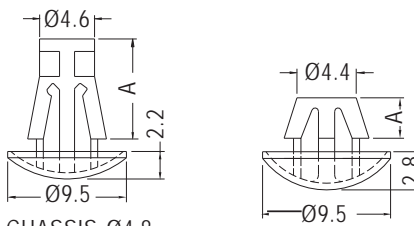
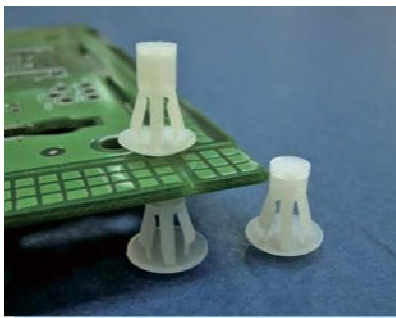

CHASSIS Ø4.8
THICKNESS 0.8-1.2

FOR RAD-3,RAD-4

PART NO	A	PACKAGE
RAD-3	3.0	1000
RAD-4	4.0	
RAD-6	6.3	
RAD-8	8.0	
RAD-10	10.0	
RAD-11	11.0	

SPACER SUPPORT

- ◆ MATERIAL:NYLON 66 (UL)
- ◆ FLAME CLASS:94V-2/94V-0
- ◆ COLOR:NATURAL/BLACK
- ◆ UNIT:mm

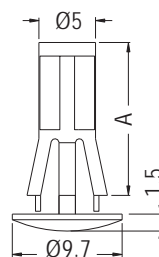

CHASSIS Ø5.5
THICKNESS 1.2-1.8

PART NO	A	PACKAGE
RAM-13.5L	13.5	1000

SPACER SUPPORT

- ◆ MATERIAL: NYLON 66 (UL)
- ◆ FLAME CLASS: 94V-2/94V-0
- ◆ COLOR: NATURAL/BLACK
- ◆ UNIT: mm

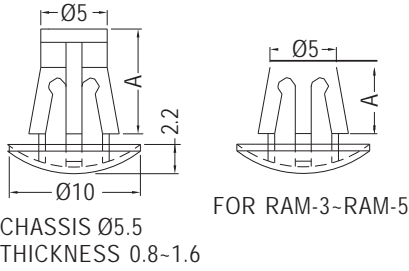

PART NO	A	PACKAGE
RAM-3	3.5	1000
RAM-5	5.0	
RAM-6	6.35	
RAM-7	7.0	
RAM-8	8.0	
RAM-8.5	8.5	

PART NO	A	PACKAGE
RAM-10	10.0	1000
RAM-12A	12.0	
RAM-12	12.7	
RAM-13.5	13.5	
RAM-14	14.0	
RAM-15	15.2	
RAM-16	15.9	
RAM-18	18.0	
RAM-19	19.0	
RAM-20	20.0	
RAM-22	21.7	500
RAM-24	24.0	
RAM-25	25.4	
RAM-30	30.0	

1

SPACER SUPPORT

- ◆ MATERIAL: NYLON 66 (UL)
- ◆ FLAME CLASS: 94V-2/94V-0
- ◆ COLOR: NATURAL/BLACK/WHITE
- ◆ UNIT: mm

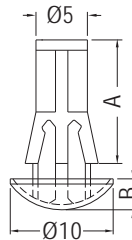
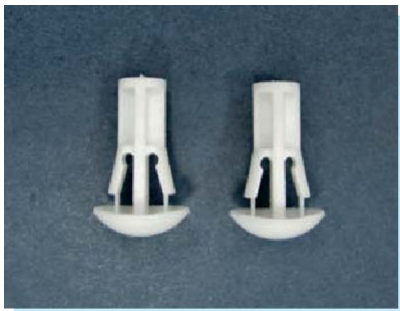

PART NO	A	B	PACKAGE
RAML-11	11.0	3.0	1000
RAML-12	12.0	2.45	

SPACER SUPPORT

- ◆ MATERIAL: NYLON 66 (UL)
- ◆ FLAME CLASS: 94V-2/94V-0
- ◆ COLOR: NATURAL/BLACK/GRAY
- ◆ UNIT: mm

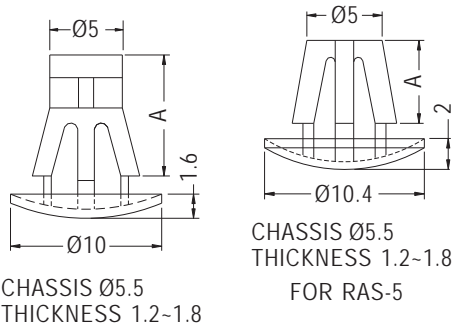
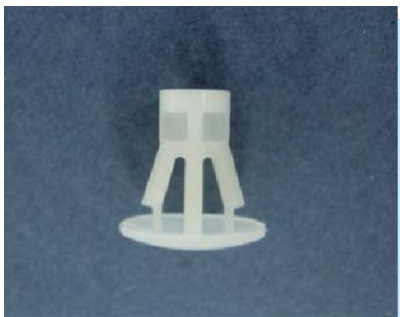

CHASSIS Ø5.5
THICKNESS 1.2~1.8

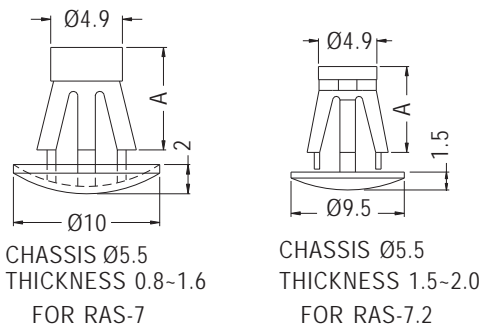

CHASSIS Ø5.5
THICKNESS 0.8~1.6
FOR RAS-7

CHASSIS Ø5.5
THICKNESS 1.5~2.0
FOR RAS-7.2

PART NO	A	PACKAGE
RAS-5	5.4	1000
RAS-6	6.0	
RAS-7	7.0	
RAS-7.2	7.2	
RAS-8	8.0	
RAS-10	10.0	
RAS-12	12.0	
RAS-14	14.0	
RAS-18	18.0	
RAS-20	20.0	



SPACER SUPPORT



- ◆ MATERIAL: NYLON 66 (UL)
- ◆ FLAME CLASS: 94V-2/94V-0
- ◆ COLOR: NATURAL/BLACK
- ◆ UNIT: mm

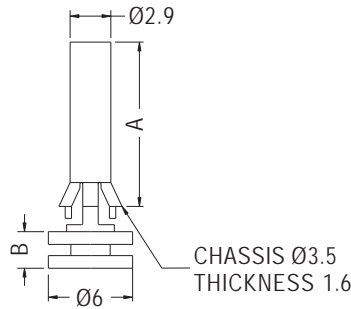

PARTNO	A	B	PACKAGE	
EDC-4	4.0	2.5	1000	
EDC-5	5.0			
EDC-6	6.0			
EDC-7	7.0			
EDC-8	8.0			
EDC-9	9.0			
EDC-10	10.0			
EDC-11.4	11.4			
EDC-12.7	12.7			
EDC-13.5	13.5			
EDC-14.5	14.5			
EDC-15	15.0			
EDC-15-4	15.0			4.0
EDC-15.9	15.9			2.5

1

SPACER SUPPORT

- ◆ MATERIAL: NYLON 66 (UL)
- ◆ FLAME CLASS: 94V-2/94V-0
- ◆ COLOR: NATURAL/BLACK
- ◆ UNIT: mm

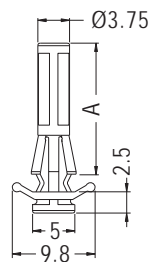
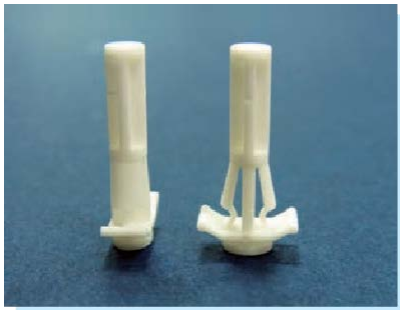

HOLE Ø4.0
THICKNESS 1.2-1.6

PART NO	A	PACKAGE
RAMC-12.5	12.5	1000
RAMC-15.5	15.5	
RAMC-19	19.0	
RAMC-24	24.0	

SPACER SUPPORT

- ◆ MATERIAL: NYLON 66 (UL)
- ◆ FLAME CLASS: 94V-2/94V-0
- ◆ COLOR: NATURAL/BLACK
- ◆ UNIT: mm

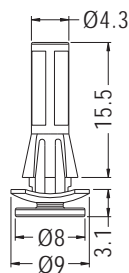

HOLE Ø4.8
THICKNESS 1.6

PARTNO	PACKAGE
RAMD-15.5	1000



SPACER SUPPORT

- ◆ MATERIAL: NYLON 66 (UL)
- ◆ FLAME CLASS: 94V-2/94V-0
- ◆ COLOR: NATURAL/BLACK
- ◆ UNIT: mm

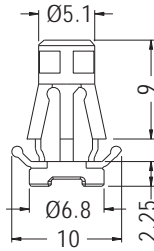

CHASSIS Ø5.6
 THICKNESS 0.8-1.6

PART NO	PACKAGE
RAMB-9	1000

SPACER SUPPORT

- ◆ MATERIAL: NYLON 66 (UL)
- ◆ FLAME CLASS: 94V-2/94V-0
- ◆ COLOR: NATURAL/BLACK
- ◆ UNIT: mm



P.C.B Ø3.0
 THICKNESS 1.6

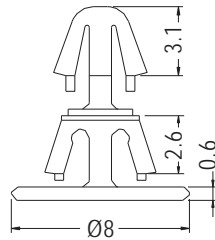

CHASSIS Ø4.0
 THICKNESS 0.5

PART NO	PACKAGE
RCI-2.6	2000

SPACER SUPPORT

- ◆ MATERIAL: NYLON 66 (UL)
- ◆ FLAME CLASS: 94V-2/94V-0
- ◆ COLOR: NATURAL/BLACK
- ◆ UNIT: mm



P.C.B Ø3.0
 THICKNESS 1.6

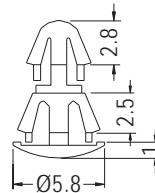

CHASSIS Ø4.0
 THICKNESS 0.6-0.8

PART NO	PACKAGE
RCO-2.5	2000

P.C.B Ø3.0
 THICKNESS 1.6-2.2

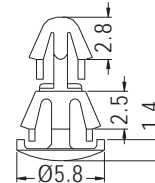

CHASSIS Ø4.0
 THICKNESS 0.8-1.2

PART NO	PACKAGE
RCO-2.5L	2000

SPACER SUPPORT



- ◆ MATERIAL: NYLON 66 (UL)
- ◆ FLAME CLASS: 94V-2/94V-0
- ◆ COLOR: NATURAL/BLACK
- ◆ UNIT: mm

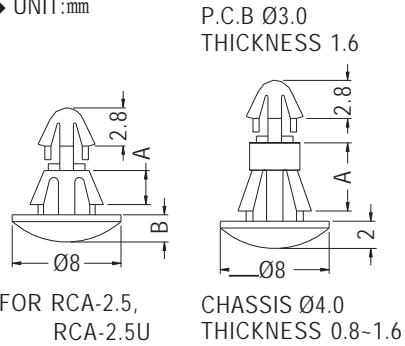

P.C.B Ø3.0
THICKNESS 1.6

P.C.B Ø3.0
THICKNESS 1.6

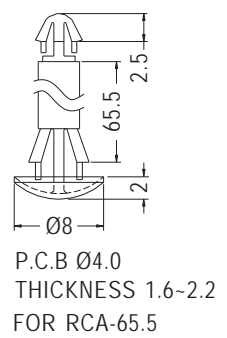
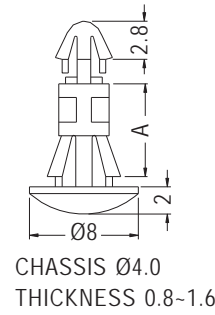

PART NO	A	B	PACKAGE
RCA-2.5U	2.5	1.8	2000
RCA-2.5	2.5	2.0	
RCA-3	3.2	2.0	
RCA-4	4.0	2.0	
RCA-4.5	4.5	2.0	
RCA-5	5.0	2.0	
RCA-5.5	5.5	2.0	

PART NO	A	PACKAGE
RCA-6	6.0	2000
RCA-6.4	6.4	
RCA-7	7.0	1000
RCA-7.5	7.5	
RCA-8	8.0	
RCA-9	9.0	
RCA-9.5	9.5	
RCA-10	10.0	
RCA-11.1	11.1	
RCA-12	12.0	
RCA-12.7	12.7	
RCA-14	14.0	
RCA-16	16.0	
RCA-65.5	65.5	

SPACER SUPPORT



- ◆ MATERIAL: NYLON 66 (UL)
- ◆ FLAME CLASS: 94V-2/94V-0
- ◆ COLOR: NATURAL/BLACK
- ◆ UNIT: mm

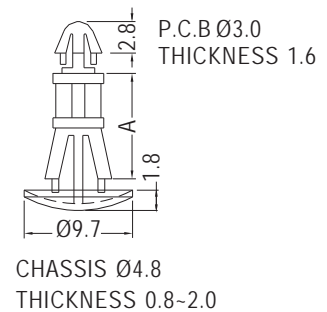
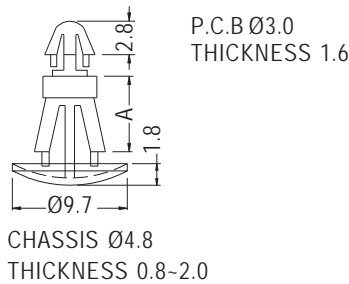

PART NO	A	PACKAGE
RCC-5	5.0	2000
RCC-6	6.3	

PART NO	A	PACKAGE
RCC-8	8.0	1000
RCC-10	10.0	
RCC-12	12.7	

SPACER SUPPORT



- ◆ MATERIAL: NYLON 66 (UL)
- ◆ FLAME CLASS: 94V-2/94V-0
- ◆ COLOR: NATURAL/BLACK
- ◆ UNIT: mm

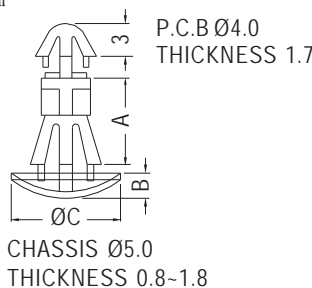

PART NO	A	B	C	PACKAGE
RCS-6	6.0	2.3	9.7	1000
RCS-13.8	13.8	2.2	10.0	
RCS-16	16.0	2.3	9.7	



SPACER SUPPORT

- ◆ MATERIAL: NYLON 66 (UL)
- ◆ FLAME CLASS: 94V-2/94V-0
- ◆ COLOR: NATURAL/BLACK
- ◆ UNIT: mm



P.C.B Ø3.0
THICKNESS 1.2-1.7

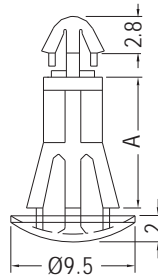

CHASSIS Ø5.5
THICKNESS 0.6-1.2

PART NO	A	PACKAGE
RCG-3.5	3.5	1000
RCG-5	4.8	
RCG-6.35	6.35	
RCG-7	7.0	
RCG-8	8.0	
RCG-10	10.0	
RCG-11	11.0	
RCG-12.7	12.7	
RCG-15.9	15.9	

1

SPACER SUPPORT

- ◆ MATERIAL: NYLON 66 (UL)
- ◆ FLAME CLASS: 94V-2/94V-0
- ◆ COLOR: NATURAL/BLACK
- ◆ UNIT: mm



P.C.B Ø3.2
THICKNESS 0.8-1.0

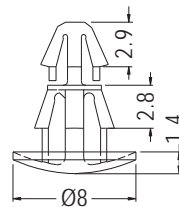

CHASSIS Ø4.0
THICKNESS 1.8

PART NO	PACKAGE
RCMB-2.8	1000

SPACER SUPPORT

- ◆ MATERIAL: NYLON 66 (UL)
- ◆ FLAME CLASS: 94V-2/94V-0
- ◆ COLOR: NATURAL/BLACK
- ◆ UNIT: mm



P.C.B Ø3.5
THICKNESS 1.6

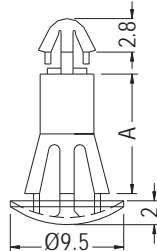

CHASSIS Ø5.5
THICKNESS 0.8-1.2
FOR RCH-3.5-RCH-8

P.C.B Ø3.5
THICKNESS 1.6

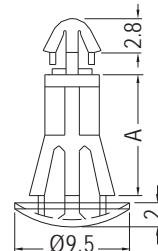

CHASSIS Ø5.5
THICKNESS 0.8-1.2
FOR RCH-10-RCH-15.9

PART NO	A	PACKAGE
RCH-3.5	3.5	1000
RCH-5	4.8	
RCH-6.35	6.35	
RCH-7	7.0	
RCH-8	8.0	
RCH-10	10.0	
RCH-11	11.0	
RCH-12.7	12.7	
RCH-15.9	15.9	



SPACER SUPPORT



- ◆ MATERIAL: NYLON 66 (UL)
- ◆ FLAME CLASS: 94V-2/94V-0
- ◆ COLOR: NATURAL/BLACK
- ◆ UNIT: mm

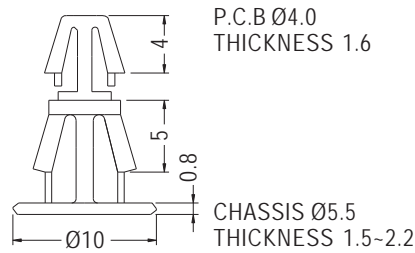

PARTNO	PACKAGE
RCI-5	2000

SPACER SUPPORT



- ◆ MATERIAL: NYLON 66 (UL)
- ◆ FLAME CLASS: 94V-2/94V-0
- ◆ COLOR: NATURAL/BLACK
- ◆ UNIT: mm

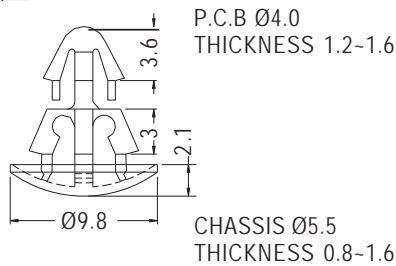

PARTNO	PACKAGE
RCMA-3	1000

SPACER SUPPORT



- ◆ MATERIAL: NYLON 66 (UL)
- ◆ FLAME CLASS: 94V-2/94V-0
- ◆ COLOR: NATURAL/BLACK
- ◆ UNIT: mm

P.C.B Ø4.0
THICKNESS 1.0-1.8

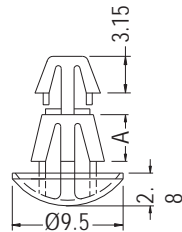

CHASSIS Ø4.8
THICKNESS 0.8-1.2
FOR RCD-3, RCD-4

P.C.B Ø4.0
THICKNESS 1.0-1.8

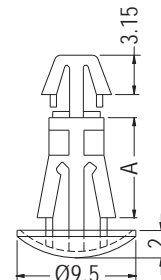

CHASSIS Ø4.8
THICKNESS 0.8-1.2

PARTNO	A	PACKAGE
RCD-3	3.0	
RCD-4	4.0	
RCD-6	6.3	2000
RCD-8	8.0	
RCD-10	10.0	
RCD-11	11.0	

SPACER SUPPORT



- ◆ MATERIAL: NYLON 66 (UL)
- ◆ FLAME CLASS: 94V-2/94V-0
- ◆ COLOR: NATURAL/BLACK
- ◆ UNIT: mm

P.C.B Ø4.0
THICKNESS 1.6

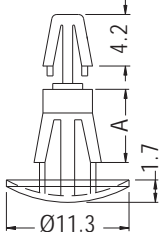

CHASSIS Ø5.5
THICKNESS 1.5-2.2
FOR RCB-3-RCB-8

P.C.B Ø4.0
THICKNESS 1.6

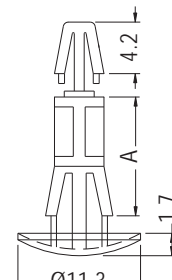

CHASSIS Ø5.5
THICKNESS 1.5-2.2

PARTNO	A	PACKAGE
RCB-3	3.5	1000
RCB-5	5.0	
RCB-6	6.35	
RCB-8	8.0	
RCB-10	10.0	
RCB-12	12.7	
RCB-15	15.9	500
RCB-19	19.0	
RCB-25	25.4	
RCB-35	35.5	



SPACER SUPPORT

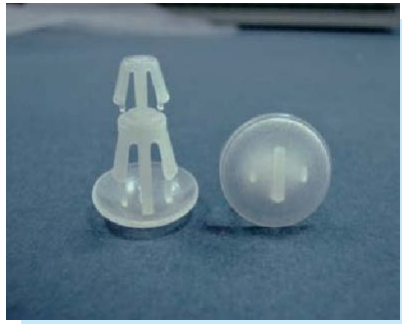

- ◆ MATERIAL: NYLON 66 (UL)
- ◆ FLAME CLASS: 94V-2/94V-0
- ◆ COLOR: NATURAL/BLACK
- ◆ UNIT: mm

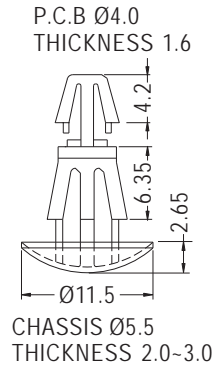

PARTNO	PACKAGE
RCBL-6	1000

SPACER SUPPORT



- ◆ MATERIAL: NYLON 66 (UL)
- ◆ FLAME CLASS: 94V-2/94V-0
- ◆ COLOR: NATURAL/BLACK
- ◆ UNIT: mm

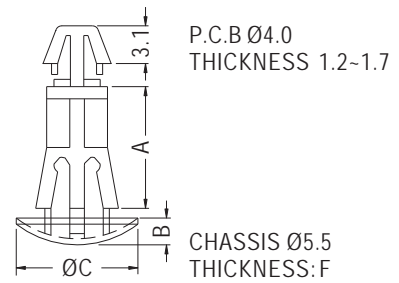
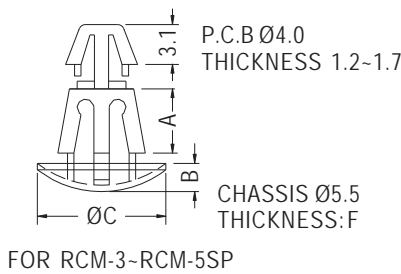

PARTNO	A	B	C	F	PACKAGE
RCM-3	3.5	2.2	10.0	0.8~1.6	1000
RCM-5	5.0				
RCM-5SP	5.0	1.5	8.0	1.6~2.0	
RCM-6	6.35	2.2	10.0		
RCM-6L	6.35				
RCM-7	7.0				
RCM-8	8.0				
RCM-8.5	8.5				
RCM-10	10.0				
RCM-12A	12.0				
RCM-12	12.7				

PARTNO	A	B	C	F	PACKAGE
RCM-13.5	13.5	2.2	10.0	0.8~1.6	1000
RCM-14	14.0				
RCM-15	15.2				
RCM-16	15.9				
RCM-18	18.0				
RCM-19	19.0				
RCM-20	20.0				
RCM-22	21.7				
RCM-24	24.0				
RCM-25	25.4				
RCM-30	30.0				

SPACER SUPPORT

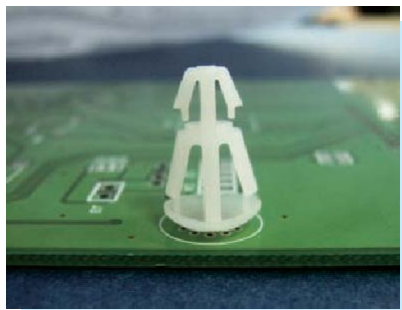

- ◆ MATERIAL: NYLON 66 (UL)
- ◆ FLAME CLASS: 94V-2/94V-0
- ◆ COLOR: NATURAL/BLACK
- ◆ UNIT: mm

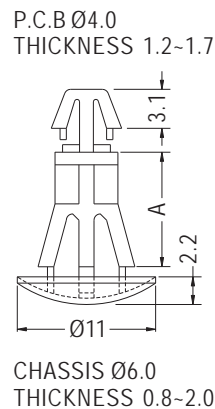
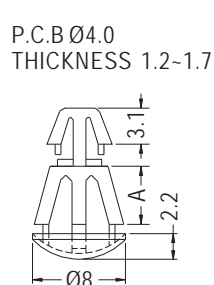

PARTNO	A	PACKAGE
RCF-5	5.0	
RCF-5S	5.0	2000
RCF-6	6.35	
RCF-8	8.0	
RCF-10	10.0	1000
RCF-12	12.7	
RCF-15	15.9	



SPACER SUPPORT



- ◆ MATERIAL: NYLON 66 (UL)
 - ◆ FLAME CLASS: 94V-2/94V-0
 - ◆ COLOR: NATURAL/BLACK
 - ◆ UNIT: mm
- CHASSIS Ø3.2
THICKNESS 1.6

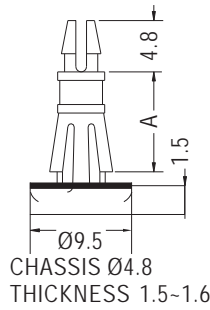

PART NO	A	PACKAGE
RCBS-6.5	6.5	1000
RCBS-9.5	9.5	
RCBS-12.7	12.7	

SPACER SUPPORT



- ◆ MATERIAL: NYLON 66 (UL)
 - ◆ FLAME CLASS: 94V-2/94V-0
 - ◆ COLOR: NATURAL/BLACK
 - ◆ UNIT: mm
- P.C.B Ø3.2
THICKNESS 1.6

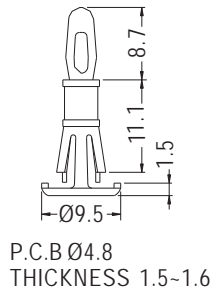

PART NO	PACKAGE
RCV-11.1	1000

SPACER SUPPORT

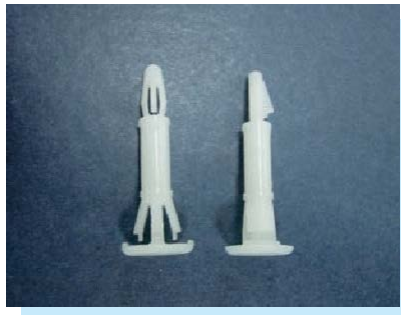

- ◆ MATERIAL: NYLON 66 (UL)
 - ◆ FLAME CLASS: 94V-2/94V-0
 - ◆ COLOR: NATURAL/BLACK
 - ◆ UNIT: mm
- P.C.B Ø3.2
THICKNESS 1.2-1.7

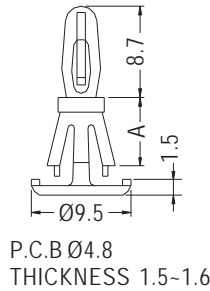

PART NO	A	PACKAGE
RCW-6.5	6.5	1000
RCW-7.9	7.9	
RCW-9.7	9.7	
RCW-11.1	11.1	
RCW-12.7	12.7	
RCW-14.3	14.3	
RCW-15.9	15.9	

SPACER SUPPORT



- ◆ MATERIAL: NYLON 66 (UL)
 - ◆ FLAME CLASS: 94V-2/94V-0
 - ◆ COLOR: NATURAL/BLACK
 - ◆ UNIT: mm
- P.C.B Ø4.0
THICKNESS 1.6

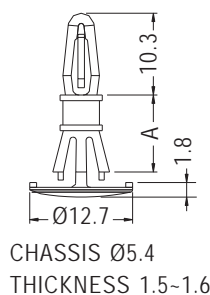

PART NO	A	PACKAGE
RCWA-6.4	6.4	1000
RCWA-9.5	9.5	
RCWA-12.7	12.7	
RCWA-15.9	15.9	
RCWA-19	19.1	
RCWA-22.2	22.2	
RCWA-25.4	25.4	

SPACERSUPPORT



- ◆ MATERIAL: NYLON 66 (UL)
- ◆ FLAME CLASS: 94V-2/94V-0
- ◆ COLOR: NATURAL/BLACK
- ◆ UNIT: mm

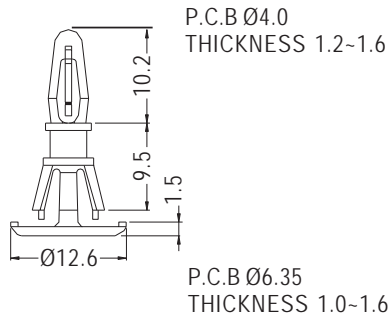

PART NO	PACKAGE
RCRA-9.5	1000

SPACER SUPPORT



- ◆ MATERIAL: NYLON 66 (UL)
- ◆ FLAME CLASS: 94V-2/94V-0
- ◆ COLOR: NATURAL/BLACK
- ◆ UNIT: mm

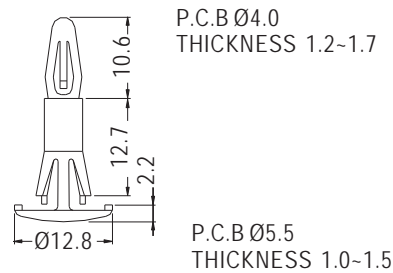

PART NO	PACKAGE
RCR-12.7	1000

SPACERSUPPORT



- ◆ MATERIAL: NYLON 66 (UL)
- ◆ FLAME CLASS: 94V-2/94V-0
- ◆ COLOR: NATURAL/WHITE/BLACK
- ◆ UNIT: mm

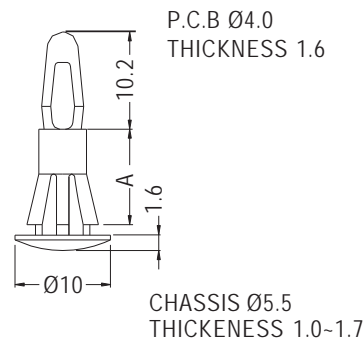

PART NO	A	PACKAGE
★ PCBT-4.8	4.8	1000
PCBT-10	10.0	

SPACER SUPPORT



- ◆ MATERIAL: NYLON 66 (UL)
- ◆ FLAME CLASS: 94V-2/94V-0
- ◆ COLOR: WHITE/BLACK
- ◆ UNIT: mm

NEW

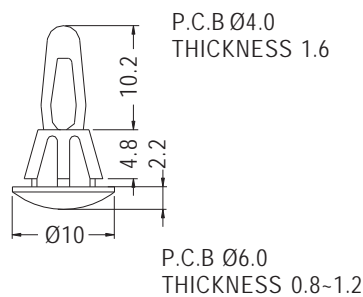

PART NO	PACKAGE
PCBTA-4.8	1000



SPACER SUPPORT

- ◆ MATERIAL: NYLON 66 (UL)
- ◆ FLAME CLASS: 94V-2/94V-0
- ◆ COLOR: NATURAL/BLACK
- ◆ UNIT: mm

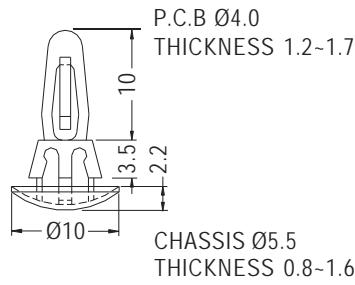

PCBS-3	1000
--------	------

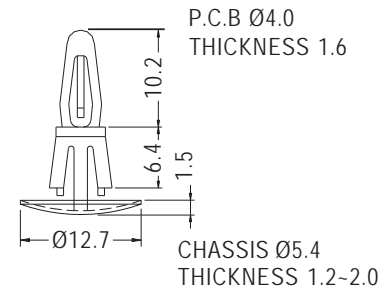

PCBS-6.4	1000
----------	------

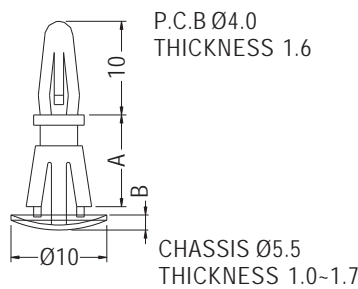

PARTNO	A	B	PACKAGE
PCBS-6	6.3	1.6	1000
PCBS-8	7.9	2.1	
PCBS-10	10.0	1.6	
PCBS-12A	12.0	1.6	
PCBS-12	12.7	1.6	

SPACER SUPPORT

- ◆ MATERIAL: NYLON 66 (UL)
- ◆ FLAME CLASS: 94V-2/94V-0
- ◆ COLOR: NATURAL/BLACK
- ◆ UNIT: mm

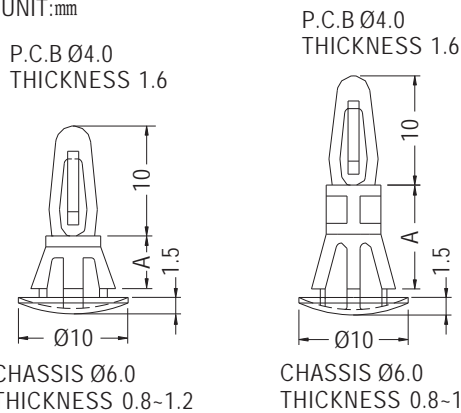
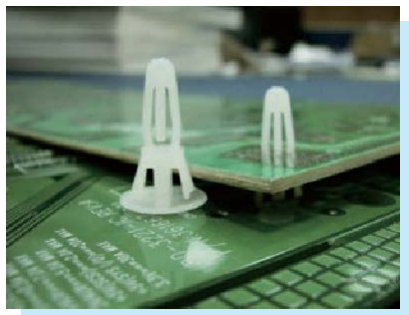

FOR RCFL-4.8, RCFL-6.4

PARTNO	A	PACKAGE
RCFL-4.8	4.8	1000
RCFL-6.4	6.4	
RCFL-8	8.0	
RCFL-9.5	9.5	
RCFL-12.7	12.7	
RCFL-19	19.0	

SPACER SUPPORT

- ◆ MATERIAL: NYLON 66 (UL)
- ◆ FLAME CLASS: 94V-2/94V-0
- ◆ COLOR: NATURAL/BLACK
- ◆ UNIT: mm



P.C.B Ø4.0
THICKNESS 1.6

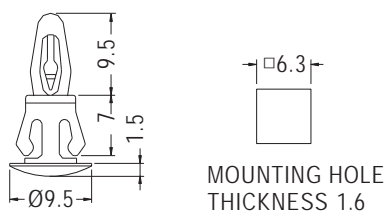

PARTNO	PACKAGE
RCFA-7	1000



SPACER SUPPORT

- ◆ MATERIAL: NYLON 66 (UL)
- ◆ FLAME CLASS: 94V-2/94V-0
- ◆ COLOR: NATURAL/BLACK
- ◆ UNIT: mm



P.C.B Ø 3.5
THICKNESS 1.2-1.7

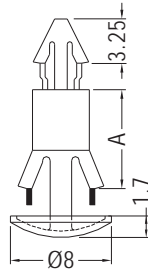

CHASSIS Ø4.8-Ø5.0
THICKNESS 1.2-1.7

PARTNO	A	PACKAGE
RCT-4.5	4.5	1000
RCT-8	7.9	

1

SPACERSUPPORT

- ◆ MATERIAL: NYLON 66 (UL)
- ◆ FLAME CLASS: 94V-2/94V-0
- ◆ COLOR: NATURAL/WHITE/BLACK
- ◆ UNIT: mm



P.C.B Ø3.5
THICKNESS 1.6-1.8

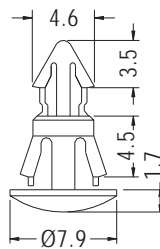

CHASSIS Ø5.5
THICKNESS 0.8

PARTNO	PACKAGE
RCTA-4.5	1000

SPACER SUPPORT

- ◆ MATERIAL: NYLON 66 (UL)
- ◆ FLAME CLASS: 94V-2/94V-0
- ◆ COLOR: NATURAL/WHITE/BLACK
- ◆ UNIT: mm



P.C.B Ø4.0
THICKNESS 1.2-1.7

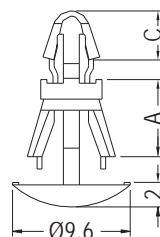

CHASSIS Ø5.4
THICKNESS 2.0

PARTNO	A	C	PACKAGE
★ RCTL-6S	6.0	3.9	1000
RCTL-6	6.3	4.0	
★ RCTL-12	12.0	3.9	

SPACER SUPPORT

- ◆ MATERIAL: NYLON 66 (UL)
 - ◆ FLAME CLASS: 94V-2/94V-0
 - ◆ COLOR: NATURAL/BLACK
 - ◆ UNIT: mm
- P.C.B Ø4.0
THICKNESS 1.6

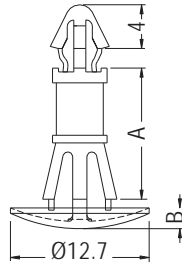

CHASSIS Ø5.4
THICKNESS 0.8-1.6

PART NO	A	B	PACKAGE
RCJ-8	8.0	2.1	1000
RCJ-10	10.0	1.7	
RCJ-12	12.0	1.7	
RCJ-12.7	12.7	1.7	

SPACER SUPPORT

- ◆ MATERIAL: NYLON 66 (UL)
- ◆ FLAME CLASS: 94V-2/94V-0
- ◆ COLOR: NATURAL/BLACK
- ◆ UNIT: mm



P.C.B Ø4.0
THICKNESS 1.2-1.6

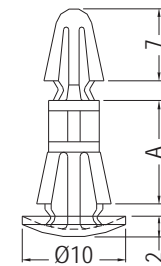

CHASSIS Ø5.5
THICKNESS 1.2-1.6

PART NO	A	PACKAGE
RBT-19	19.0	1000
RBT-28.2	28.2	

P.C.B Ø4.0
THICKNESS 3.0

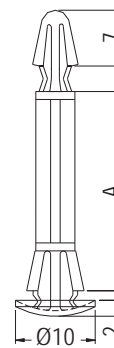

CHASSIS Ø5.5
THICKNESS 1.2-1.6

PART NO	A	PACKAGE
RBT-16L	16.0	1000
RBT-25L	25.0	

SPACER SUPPORT

- ◆ MATERIAL: NYLON 66 (UL)
- ◆ FLAME CLASS: 94V-2/94V-0
- ◆ COLOR: NATURAL/BLACK
- ◆ UNIT: mm



P.C.B Ø4.0
THICKNESS 1.2-1.7

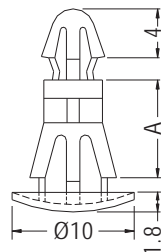

CHASSIS Ø5.5
THICKNESS 1.2-1.8

PART NO	A	PACKAGE
RBS-5	5.0	1000
RBS-6	6.0	
RBS-7	7.0	
RBS-8	8.0	
RBS-10	10.0	
RBS-11	11.0	
RBS-12	12.0	
RBS-14	14.0	
RBS-18	18.0	
RBS-20	20.0	



SPACER SUPPORT



- ◆ MATERIAL: NYLON 66 (UL)
- ◆ FLAME CLASS: 94V-2/94V-0
- ◆ COLOR: NATURAL/BLACK
- ◆ UNIT: mm

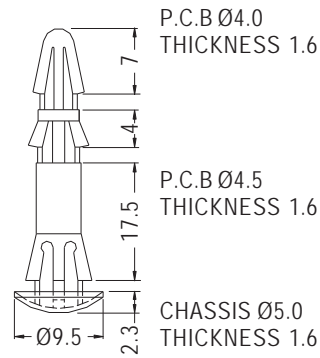

PART NO	PACKAGE
DRCB-18	1000

SPACERSUPPORT

- ◆ MATERIAL: NYLON 66 (UL)
- ◆ FLAME CLASS: 94V-2/94V-0
- ◆ COLOR: NATURAL/BLACK
- ◆ UNIT: mm

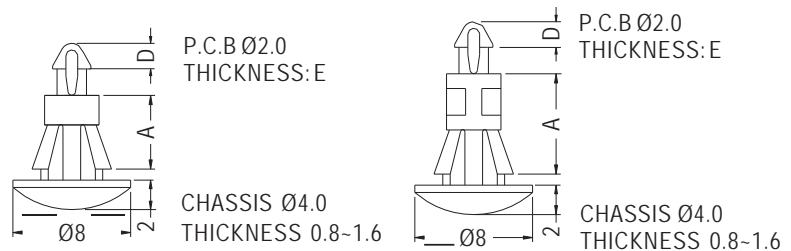

FOR RCAB-3-RCAB-5.5

PART NO	A	D	E	PACKAGE
RCAB-3	3.2	1.74	1.6	1000
RCAB-4.5	4.5			
★ RCAB-4.5S	4.5	1.75	1.0	
RCAB-5.5	5.5	1.74	1.6	
RCAB-6.4	6.4			
RCAB-7.5	7.5			
RCAB-9.5	9.5			
RCAB-11.1	11.1			
RCAB-12.7	12.7			

SPACERSUPPORT

- ◆ MATERIAL: NYLON 66 (UL)
- ◆ FLAME CLASS: 94V-2/94V-0
- ◆ COLOR: NATURAL/BLACK
- ◆ UNIT: mm

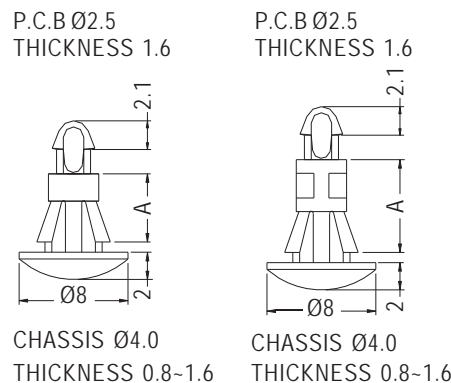

FOR RCAC-3-RCAC-5.5

PART NO	A	PACKAGE
RCAC-3	3.0	1000
RCAC-4.5	4.5	
RCAC-5.5	5.5	
RCAC-6.4	6.4	
RCAC-7.5	7.5	
RCAC-9.5	9.5	
RCAC-11.1	11.1	
RCAC-12.7	12.7	



SPACER SUPPORT



- ◆ MATERIAL: NYLON 66 (UL)
- ◆ FLAME CLASS: 94V-2/94V-0
- ◆ COLOR: NATURAL/BLACK
- ◆ UNIT: mm

P.C.B Ø1.5
THICKNESS 1.0

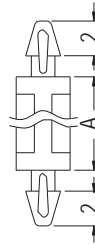

P.C.B Ø1.5
THICKNESS 1.0

PART NO	A	PACKAGE
MASD-14	14.0	2000
MASD-18	18.0	

SPACER SUPPORT



- ◆ MATERIAL: NYLON 66 (UL)
- ◆ FLAME CLASS: 94V-2/94V-0
- ◆ COLOR: NATURAL/BLACK
- ◆ UNIT: mm

P.C.B Ø1.6
THICKNESS 0.7

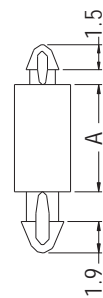

P.C.B Ø2.0
THICKNESS 1.6

PART NO	A	PACKAGE
MADS-6.5	6.5	2000
★ MADS-19.2	19.2	1000

P.C.B Ø1.6
THICKNESS 1.0

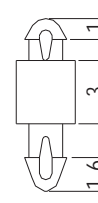

P.C.B Ø1.6
THICKNESS 1.6

PART NO	PACKAGE
★ MADSA-3	1000

SPACER SUPPORT



- ◆ MATERIAL: NYLON 66 (UL)
- ◆ FLAME CLASS: 94V-2/94V-0
- ◆ COLOR: NATURAL/BLACK
- ◆ UNIT: mm

P.C.B Ø1.6
THICKNESS 1.5

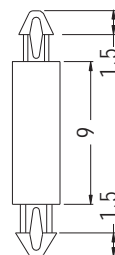

P.C.B Ø2.0
THICKNESS 1.6

PART NO	PACKAGE
MAS-9	1000



SPACER SUPPORT



- ◆ MATERIAL: NYLON 66 (UL)
- ◆ FLAME CLASS: 94V-2/94V-0
- ◆ COLOR: NATURAL/BLACK
- ◆ UNIT: mm

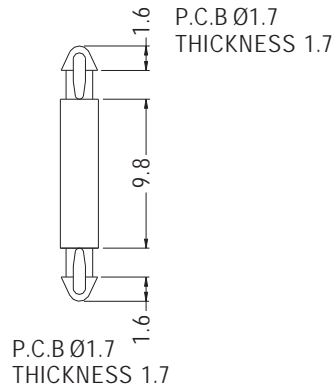

PART NO	PACKAGE
MAD1.7-9.8	1000

SPACER SUPPORT



- ◆ MATERIAL: NYLON 66 (UL)
- ◆ FLAME CLASS: 94V-2/94V-0
- ◆ COLOR: NATURAL/BLACK
- ◆ UNIT: mm

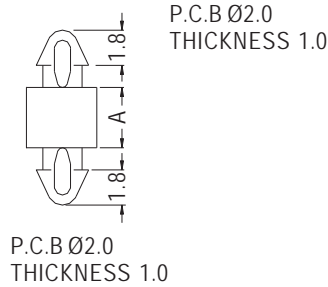

PART NO	A	PACKAGE
MAD1-3	3.0	2000
MAD1-19	19.0	1000

SPACER SUPPORT



- ◆ MATERIAL: NYLON 66 (UL)
- ◆ FLAME CLASS: 94V-2/94V-0
- ◆ COLOR: NATURAL/BLACK
- ◆ UNIT: mm

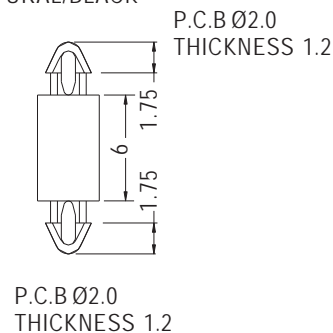

PART NO	PACKAGE
MAD1.2-6	1000

SPACER SUPPORT



- ◆ MATERIAL: NYLON 66 (UL)
- ◆ FLAME CLASS: 94V-2/94V-0
- ◆ COLOR: NATURAL/BLACK
- ◆ UNIT: mm

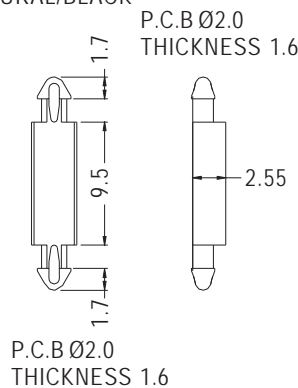

PART NO	PACKAGE
MADX-9.5	1000



SPACER SUPPORT

- ◆ MATERIAL: NYLON 66 (UL)
- ◆ FLAME CLASS: 94V-2/94V-0
- ◆ COLOR: NATURAL/BLACK
- ◆ UNIT: mm



P.C.B Ø2.0
THICKNESS 1.6

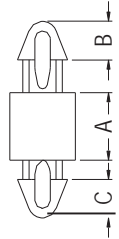

CHASSIS Ø2.0
THICKNESS: E

PART NO	A	B	C	E	PACKAGE
MADB-3.5	3.5	2.0	2.0	0.9	2000
MADB-6	6.0	1.9	1.9	0.8	

SPACER SUPPORT

- ◆ MATERIAL: NYLON 66 (UL)
- ◆ FLAME CLASS: 94V-2/94V-0
- ◆ COLOR: NATURAL/BLACK
- ◆ UNIT: mm

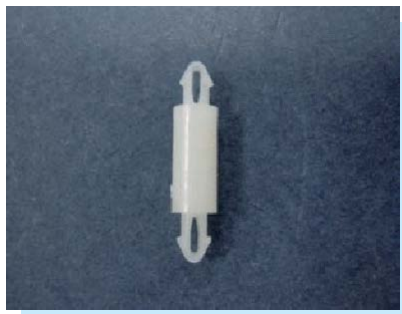

P.C.B Ø2.0
THICKNESS 1.6

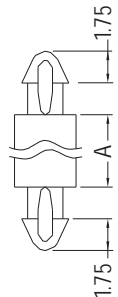

P.C.B Ø2.0
THICKNESS 1.6

P.C.B Ø2.0
THICKNESS 1.6

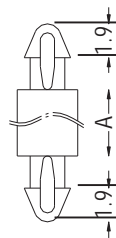

P.C.B Ø2.0
THICKNESS 1.6
FOR MAD-14

PART NO	A	PACKAGE
★ MAD-1.6	1.6	2000
MAD-2.2	2.2	
MAD-3	3.0	
MAD-3.5	3.5	
MAD-4	4.0	
MAD-5	5.0	
MAD-6	6.0	
MAD-6.5	6.5	
MAD-7	7.0	
MAD-8	8.0	
MAD-10S	10.0	
MAD-10	10.5	
MAD-12.5	12.5	
MAD-14	14.0	
MAD-25	25.0	

SPACER SUPPORT

- ◆ MATERIAL: NYLON 66 (UL)
- ◆ FLAME CLASS: 94V-2/94V-0
- ◆ COLOR: NATURAL/BLACK
- ◆ UNIT: mm



HOLE Ø2.0
THICKNESS 1.0

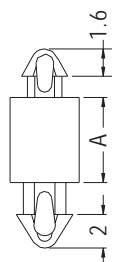

P.C.B Ø2.5
THICKNESS 1.6

PART NO	A	PACKAGE
MAMDA-1.6	1.6	1000
MAMDA-2.5	2.5	
MAMDA-3.2	3.2	
MAMDA-4	4.0	
MAMDA-4.8	4.8	
MAMDA-5.5	5.5	
MAMDA-6.4	6.4	
MAMDA-7	7.0	
MAMDA-7.9	7.9	
MAMDA-9.5	9.5	
MAMDA-10	10.0	
MAMDA-12.7	12.7	



SPACER SUPPORT



- ◆ MATERIAL: NYLON 66 (UL)
- ◆ FLAME CLASS: 94V-2/94V-0
- ◆ COLOR: NATURAL/BLACK
- ◆ UNIT: mm

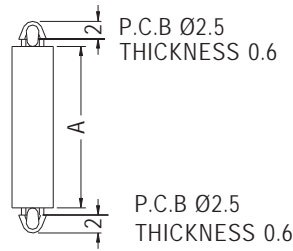

PARTNO	A	PACKAGE
MADA-18S	18.0	2000

SPACER SUPPORT

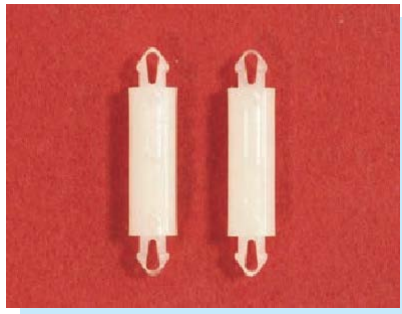

- ◆ MATERIAL: NYLON 66 (UL)
- ◆ FLAME CLASS: 94V-2/94V-0
- ◆ COLOR: NATURAL/BLACK
- ◆ UNIT: mm

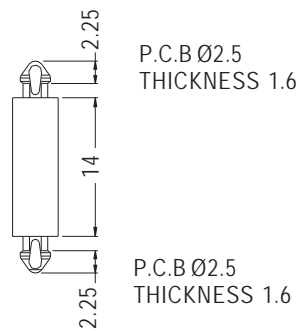

PARTNO	PACKAGE
MADAA-14	1000

SPACER SUPPORT

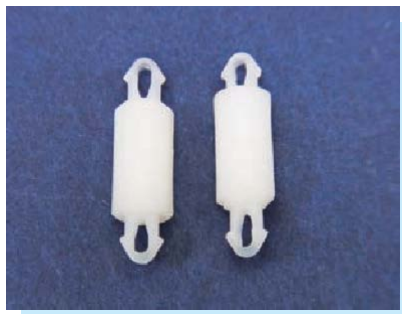

- ◆ MATERIAL: NYLON 66 (UL)
- ◆ FLAME CLASS: 94V-2/94V-0
- ◆ COLOR: NATURAL/BLACK
- ◆ UNIT: mm

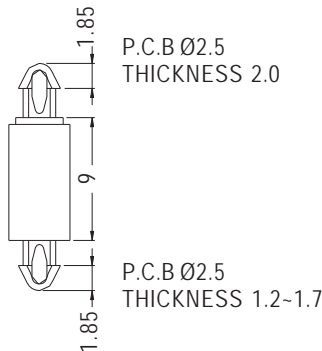

PARTNO	PACKAGE
MAMDL-9	1000

SPACER SUPPORT

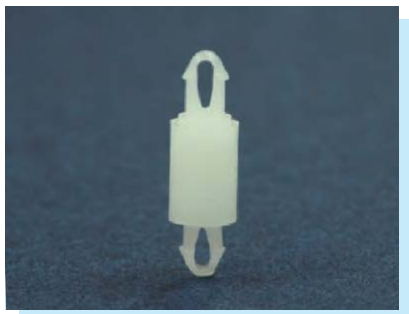

- ◆ MATERIAL: NYLON 66 (UL)
- ◆ FLAME CLASS: 94V-2/94V-0
- ◆ COLOR: NATURAL/BLACK
- ◆ UNIT: mm

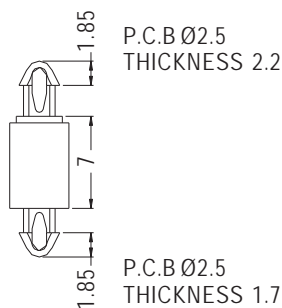

PARTNO	PACKAGE
MAMDF-7	1000

SPACER SUPPORT

- ◆ MATERIAL: NYLON 66 (UL)
- ◆ FLAME CLASS: 94V-2/94V-0
- ◆ COLOR: NATURAL/BLACK
- ◆ UNIT: mm



P.C.B Ø2.5
THICKNESS 1.6

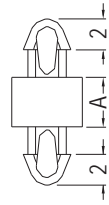

P.C.B Ø2.5
THICKNESS 1.6

P.C.B Ø2.5
THICKNESS 1.6

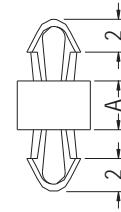

P.C.B Ø2.5
THICKNESS 1.6
FOR MADA-3-1

PART NO	A	PACKAGE
MADA-2	2.0	2000
MADA-3	3.0	
MADA-3-1	3.0	
MADA-3.5	3.5	
MADA-4	4.0	
MADA-5	5.0	
MADA-6	6.0	
MADA-7	7.0	
MADA-8	8.0	
MADA-8.5	8.5	

PART NO	A	PACKAGE
MADA-9	9.0	2000
MADA-10	10.0	
MADA-11	11.0	
MADA-12	12.0	
MADA-12.7	12.7	
MADA-14	14.0	
MADA-16	16.0	
MADA-18	18.0	
MADA-20	20.0	
MADA-22	22.0	

SPACER SUPPORT

- ◆ MATERIAL: NYLON 66 (UL)
- ◆ FLAME CLASS: 94V-2/94V-0
- ◆ COLOR: NATURAL/BLACK
- ◆ UNIT: mm



P.C.B Ø2.5
THICKNESS 1.6

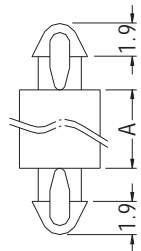

P.C.B Ø2.5
THICKNESS 1.6
FOR MADM-2~MADM-5

P.C.B Ø2.5
THICKNESS 1.6

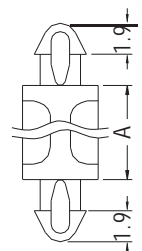

P.C.B Ø2.5
THICKNESS 1.6

PART NO	A	PACKAGE
MADM-2	2.0	2000
MADM-2.7S	2.7	
MADM-3	3.0	
MADM-3S	3.0	
MADM-4	4.0	
MADM-4.5	4.5	
MADM-5	5.0	
MADM-6	6.0	
MADM-6.5	6.5	
MADM-7.5	7.5	
MADM-8	8.0	
MADM-9.5	9.5	
MADM-10A	10.0	
MADM-10	10.5	
MADM-12.7	12.7	
MADM-27	27.0	



P.C.B Ø2.5
THICKNESS 1.6

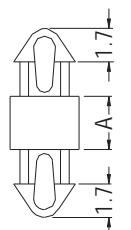

P.C.B Ø2.5
THICKNESS 1.6
FOR MADM-2.7S,
MADM-3S

P.C.B Ø2.5
THICKNESS 1.6

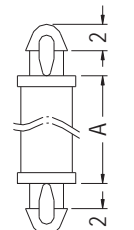

P.C.B Ø2.5
THICKNESS 1.6
FOR MADM-12.7



SPACER SUPPORT



- ◆ MATERIAL: NYLON 66 (UL)
- ◆ FLAME CLASS: 94V-2/94V-0
- ◆ COLOR: NATURAL/BLACK
- ◆ UNIT: mm

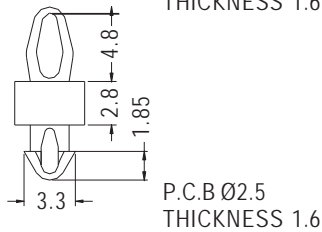

PART NO	PACKAGE
MADE-2.8	1000

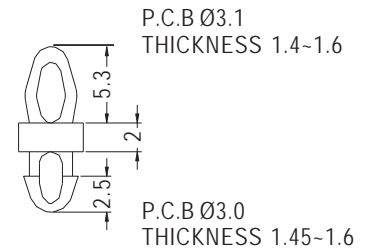

PART NO	PACKAGE
MADD-2	1000

SPACER SUPPORT



- ◆ MATERIAL: NYLON 66 (UL)
- ◆ FLAME CLASS: 94V-2/94V-0
- ◆ COLOR: NATURAL/BLACK
- ◆ UNIT: mm

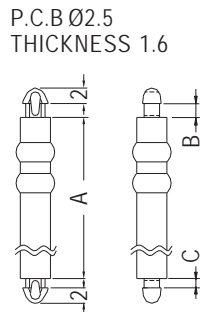

P.C.B Ø2.5
THICKNESS 1.0

PART NO	A	B	C	PACKAGE
MAC-40	40.0	1.8	1.2	500
MAC-40S	39.95	1.5	1.0	

SPACER SUPPORT



- ◆ MATERIAL: NYLON 66 (UL)
- ◆ FLAME CLASS: 94V-2/94V-0
- ◆ COLOR: NATURAL/BLACK
- ◆ UNIT: mm

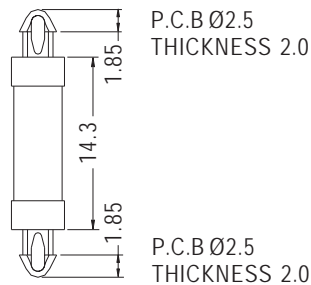

P.C.B Ø2.5
THICKNESS 2.0

PART NO	PACKAGE
MAHC-14.3	1000

SPACER SUPPORT



- ◆ MATERIAL: NYLON 66 (UL)
- ◆ FLAME CLASS: 94V-2/94V-0
- ◆ COLOR: NATURAL/BLACK
- ◆ UNIT: mm

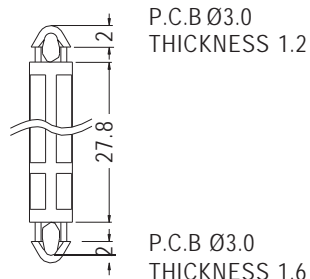

P.C.B Ø3.0
THICKNESS 1.6

PART NO	PACKAGE
MADL-27.8	1000



SPACER SUPPORT



- ◆ MATERIAL:NYLON 66 (UL)
- ◆ FLAME CLASS:94V-2/94V-0
- ◆ COLOR:NATURAL/BLACK
- ◆ UNIT:mm

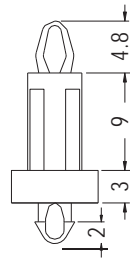

P.C.B Ø3.0
THICKNESS 1.2

P.C.B Ø3.0
THICKNESS 1.6

PART NO	PACKAGE
MAMDC-12	1000

SPACER SUPPORT



- ◆ MATERIAL:NYLON 66 (UL)
- ◆ FLAME CLASS:94V-2/94V-0
- ◆ COLOR:NATURAL/BLACK
- ◆ UNIT:mm

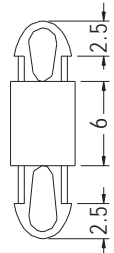

P.C.B Ø3.5
THICKNESS 1.6

CHASSIS Ø3.5
THICKNESS 2.5

PART NO	PACKAGE
MAFA-6	1000

SPACER SUPPORT



- ◆ MATERIAL:NYLON 66 (UL)
- ◆ FLAME CLASS:94V-2/94V-0
- ◆ COLOR:NATURAL/BLACK
- ◆ UNIT:mm

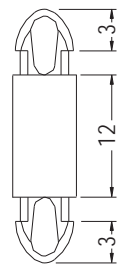

P.C.B Ø3.5
THICKNESS 1.6

P.C.B Ø3.5
THICKNESS 1.6

PART NO	PACKAGE
MAD3.5-12	1000

SPACER SUPPORT



- ◆ MATERIAL:NYLON 66 (UL)
- ◆ FLAME CLASS:94V-2/94V-0
- ◆ COLOR:NATURAL/BLACK
- ◆ UNIT:mm

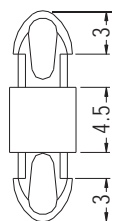

P.C.B Ø3.5
THICKNESS 2.1

P.C.B Ø3.5
THICKNESS 1.6

PART NO	PACKAGE
MDLS-4.5	1000



SPACER SUPPORT

- ◆ MATERIAL: NYLON 66 (UL)
- ◆ FLAME CLASS: 94V-2/94V-0
- ◆ COLOR: NATURAL/BLACK
- ◆ UNIT: mm



P.C.B Ø3.5
THICKNESS 1.6

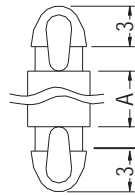

P.C.B Ø3.5
THICKNESS 1.6

PARTNO	A	PACKAGE
MAF-2	2.0	1000
MAF-3	3.0	
MAF-4	4.0	
MAF-5	5.0	
MAF-6	6.0	
MAF-7	7.0	
MAF-8	8.0	

PARTNO	A	PACKAGE
MAF-10	10.0	1000
MAF-12	12.0	
MAF-14	14.0	
MAF-16	16.0	
MAF-18	18.0	
MAF-20	20.0	
MAF-22	22.0	

SPACER SUPPORT

- ◆ MATERIAL: NYLON 66 (UL)
- ◆ FLAME CLASS: 94V-2/94V-0
- ◆ COLOR: NATURAL/WHITE/BLACK
- ◆ UNIT: mm



P.C.B Ø5.0
THICKNESS 0.8

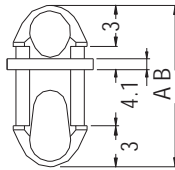

P.C.B Ø5.0
THICKNESS 4.0

PARTNO	A	B	PACKAGE
MAFB5-0.8	0.8	11.8	1000
MAFB5-9.7	9.7	20.7	

SPACER SUPPORT

- ◆ MATERIAL: NYLON 66 (UL)
- ◆ FLAME CLASS: 94V-2/94V-0
- ◆ COLOR: NATURAL/BLACK
- ◆ UNIT: mm

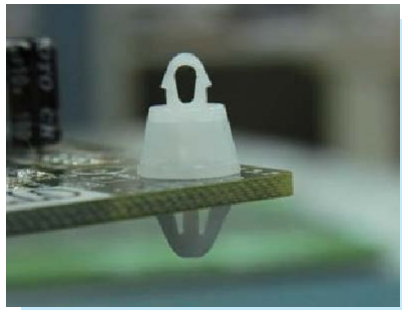

P.C.B Ø1.5
THICKNESS 0.8

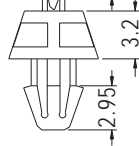

CHASSIS Ø3.0
THICKNESS 1.6

PARTNO	PACKAGE
MAEB-3.2	1000

P.C.B Ø2.5
THICKNESS 1.0

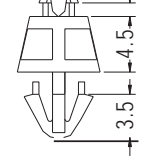

CHASSIS Ø4.0
THICKNESS 1.6

PARTNO	PACKAGE
MAEE-4.5	1000

P.C.B Ø3.0
THICKNESS 1.0

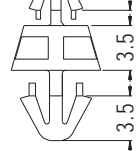

CHASSIS Ø4.0
THICKNESS 1.6

PARTNO	PACKAGE
MAEA-3.5M	1000

P.C.B Ø3.0
THICKNESS 1.0

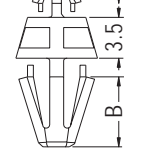

CHASSIS Ø4.8
THICKNESS: E

PARTNO	B	E	PACKAGE
MAEA-3.5	6.0	1.2	1000
MAEA-3.5L	6.0	1.6	
MAEA-3.5LS	4.1	1.6	



SPACERSUPPORT



- ◆ MATERIAL: NYLON 66 (UL)
- ◆ FLAME CLASS: 94V-2/94V-0
- ◆ COLOR: NATURAL/BLACK
- ◆ UNIT: mm

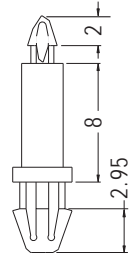

P.C.B Ø1.5
THICKNESS 1.0

CHASSIS Ø3.0
THICKNESS 1.6

PART NO	PACKAGE
LCMB-8	1000

1

SPACERSUPPORT

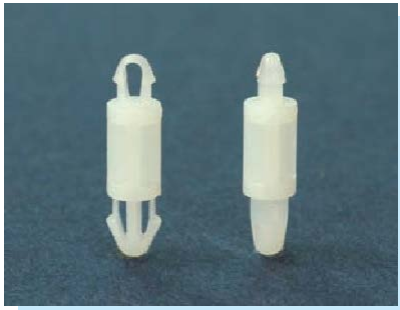

- ◆ MATERIAL: NYLON 66 (UL)
- ◆ FLAME CLASS: 94V-2/94V-0
- ◆ COLOR: NATURAL/BLACK
- ◆ UNIT: mm

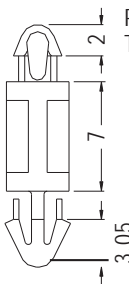

P.C.B Ø2.5
THICKNESS 1.6

P.C.B Ø3.0
THICKNESS 1.6

PART NO	PACKAGE
LCMC-7	1000

SPACER SUPPORT



- ◆ MATERIAL: NYLON 66 (UL)
- ◆ FLAME CLASS: 94V-2/94V-0
- ◆ COLOR: NATURAL/BLACK
- ◆ UNIT: mm

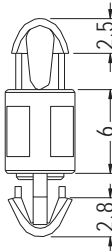

P.C.B Ø3.5
THICKNESS 2.4

P.C.B Ø3.5
THICKNESS 1.6

PART NO	PACKAGE
MAMDD-6	1000

SPACER SUPPORT



- ◆ MATERIAL: NYLON 66 (UL)
- ◆ FLAME CLASS: 94V-2/94V-0
- ◆ COLOR: NATURAL/BLACK
- ◆ UNIT: mm

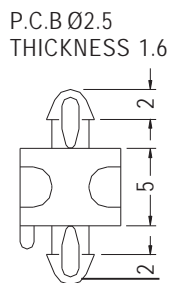

P.C.B Ø2.5
THICKNESS 1.6

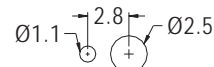

MOUNTING HOLES

PART NO	PACKAGE
MADMK-5	2000



SPACERSUPPORT

- ◆ MATERIAL: NYLON 66 (UL)
- ◆ FLAME CLASS: 94V-2/94V-0
- ◆ COLOR: NATURAL/BLACK
- ◆ UNIT: mm



P.C.B Ø3.0
THICKNESS 1.7

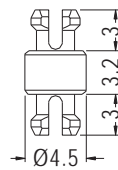

P.C.B Ø3.0
THICKNESS 1.7
BODY

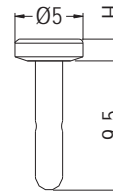

PIN

PART NO	H	PACKAGE
MSPC3-3.2	1.6	1000
★ MSPC3-3.2M	3.0	

SPACERSUPPORT

- ◆ MATERIAL: NYLON 66 (UL)
- ◆ FLAME CLASS: 94V-2/94V-0
- ◆ COLOR: NATURAL/BLACK
- ◆ UNIT: mm

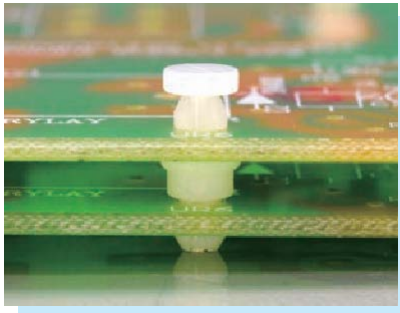

P.C.B Ø3.0
THICKNESS 1.1

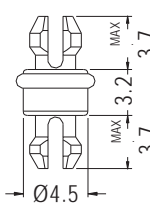

P.C.B Ø3.0
THICKNESS 1.7~2.0
BODY

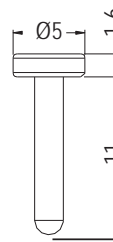

PIN

PART NO	PACKAGE
MSPC3-3.2L	1000

SPACER SUPPORT

- ◆ MATERIAL: NYLON 66 (UL)
- ◆ FLAME CLASS: 94V-2/94V-0
- ◆ COLOR: NATURAL/BLACK
- ◆ UNIT: mm

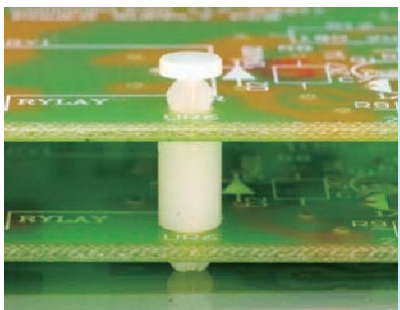

P.C.B Ø3.0
THICKNESS 1.6

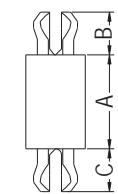

P.C.B Ø3.0
THICKNESS 1.6
BODY

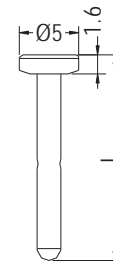

PIN

PART NO	A	B	C	L	PACKAGE
MSPF3-6.4	6.35	3.6	3.6	15.75	2000
MSPF3-8	7.9			17.3	
MSPF3-10	10.0			19.4	
MSPF3-12.7	12.7			22.1	
MSPF3-15.9	15.9			25.3	



SPACERSUPPORT



- ◆ MATERIAL: NYLON 66 (UL)
- ◆ FLAME CLASS: 94V-2/94V-0
- ◆ COLOR: NATURAL/BLACK
- ◆ UNIT: mm

P.C.B Ø3.2
THICKNESS 0.9

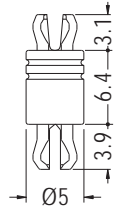

P.C.B Ø3.2
THICKNESS 1.7
BODY

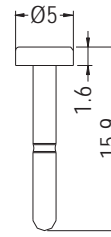

PIN

PART NO	PACKAGE
MSPB3.2-6.4	1000

SPACERSUPPORT



- ◆ MATERIAL: NYLON 66 (UL)
- ◆ FLAME CLASS: 94V-2/94V-0
- ◆ COLOR: NATURAL/BLACK
- ◆ UNIT: mm

P.C.B Ø3.3
THICKNESS 1.6

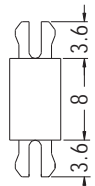

P.C.B Ø3.3
THICKNESS 1.6
BODY

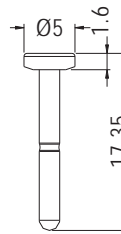

PIN

PART NO	PACKAGE
MSPF3.3-8	1000

SPACER SUPPORT



- ◆ MATERIAL: NYLON 66 (UL)
- ◆ FLAME CLASS: 94V-2/94V-0
- ◆ COLOR: NATURAL/BLACK
- ◆ UNIT: mm

P.C.B Ø3.2
THICKNESS 1.6

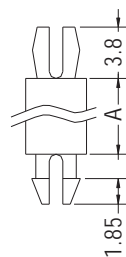

P.C.B Ø3.2
THICKNESS 1.6

P.C.B Ø3.2
THICKNESS 1.73

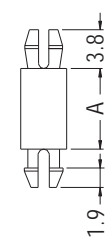

P.C.B Ø3.2
THICKNESS 1.6

FOR MSP3-8L

PART NO	A	PACKAGE
MSP3-3	3.2	1000
MSP3-5	4.8	
MSP3-5.8	5.8	
MSP3-6	6.4	
MSP3-8	7.9	
★ MSP3-8L	7.9	
MSP3-8.5	8.6	
MSP3-9.5	9.5	
MSP3-10	10.0	
MSP3-11	11.1	
MSP3-12	12.7	
MSP3-14	14.3	
MSP3-15.9	15.9	
MSP3-16	16.0	

PART NO	A	PACKAGE
MSP3-17	17.5	1000
MSP3-19	19.1	
MSP3-20	20.6	
MSP3-21	21.0	
MSP3-22	22.2	
MSP3-25	25.4	
MSP3-27	27.0	
MSP3-28	28.5	
MSP3-29.2	29.2	
MSP3-31.7	31.7	
MSP3-31.8	31.8	
MSP3-34	34.9	
MSP3-38	38.1	



SPACERSUPPORT

- ◆ MATERIAL: NYLON 66 (UL)
- ◆ FLAME CLASS: 94V-2/94V-0
- ◆ COLOR: NATURAL/BLACK
- ◆ UNIT: mm



P.C.B Ø3.2
THICKNESS 1.6

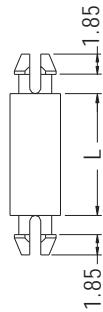

P.C.B Ø3.2
THICKNESS 1.6

PART NO	L	PACKAGE
MSPS3-3.2	3.2	1000
MSPS3-4.8	4.8	
MSPS3-6.4	6.4	
MSPS3-8	7.9	
MSPS3-9.5	9.5	
MSPS3-11.1	11.1	
MSPS3-12.7	12.7	
MSPS3-14.3	14.3	
MSPS3-15.9	15.9	
MSPS3-19.1	19.1	
MSPS3-20.6	20.6	
MSPS3-22.2	22.2	
MSPS3-25.4	25.4	
MSPS3-31.8	31.8	
MSPS3-34.9	34.9	

SPACERSUPPORT



- ◆ MATERIAL: NYLON 66 (UL)
- ◆ FLAME CLASS: 94V-2/94V-0
- ◆ COLOR: NATURAL/BLACK
- ◆ UNIT: mm

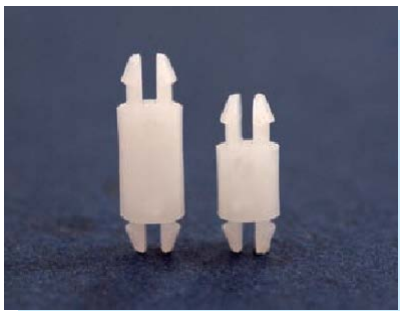

P.C.B Ø3.2
THICKNESS 1.6

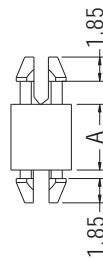

P.C.B Ø3.2
THICKNESS 0.5

PART NO	A	PACKAGE
DMSB-5	5.0	1000
DMSB-8	8.0	

SPACERSUPPORT



- ◆ MATERIAL: NYLON 66 (UL)
- ◆ FLAME CLASS: 94V-2/94V-0
- ◆ COLOR: NATURAL/BLACK
- ◆ UNIT: mm



P.C.B Ø3.2
THICKNESS 2.4



P.C.B Ø3.2
THICKNESS 1.6

PART NO	PACKAGE
MSPL-11	1000



SPACER SUPPORT



- ◆ MATERIAL: NYLON 66 (UL)
- ◆ FLAME CLASS: 94V-2/94V-0
- ◆ COLOR: NATURAL/BLACK
- ◆ UNIT: mm

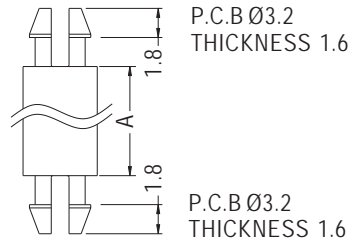

PART NO	A	PACKAGE
DMSS-28	28.6	1000
DMSS-38	38.1	

1

SPACER SUPPORT



- ◆ MATERIAL: NYLON 66 (UL)
- ◆ FLAME CLASS: 94V-2/94V-0
- ◆ COLOR: NATURAL/BLACK
- ◆ UNIT: mm

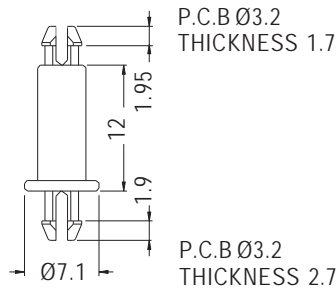

PART NO	PACKAGE
MSPMA-12	1000

SPACER SUPPORT

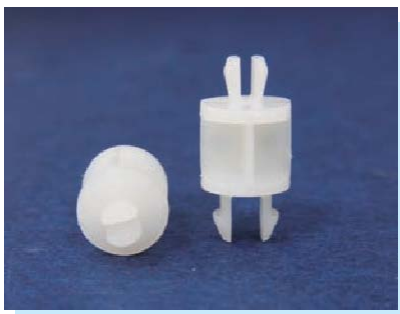

- ◆ MATERIAL: NYLON 66 (UL)
- ◆ FLAME CLASS: 94V-2/94V-0
- ◆ COLOR: NATURAL/BLACK
- ◆ UNIT: mm

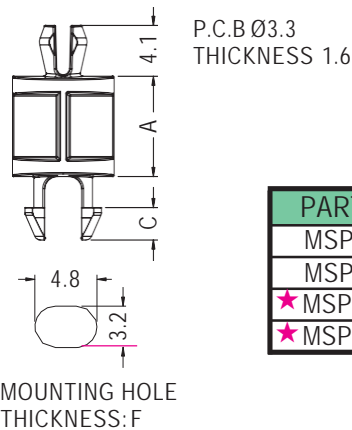

PART NO	A	C	F	PACKAGE
MSPD-7.9	7.9	2.6	2.16	1000
MSPD-7.9S	7.9	2.55	1.6	
★ MSPD-12	12.0	2.55	2.16	
★ MSPD-16	16.0	2.45	2.16	

SPACER SUPPORT



- ◆ MATERIAL: NYLON 66 (UL)
- ◆ FLAME CLASS: 94V-2/94V-0
- ◆ COLOR: NATURAL/BLACK
- ◆ UNIT: mm

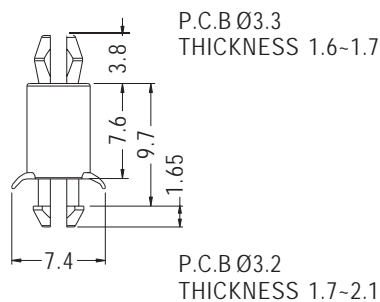

PART NO	PACKAGE
MSPH-7.5	1000



SPACER SUPPORT

- ◆ MATERIAL: NYLON 66 (UL)
- ◆ FLAME CLASS: 94V-2/94V-0
- ◆ COLOR: NATURAL/BLACK
- ◆ UNIT: mm



P.C.B Ø4.0
THICKNESS 1.6

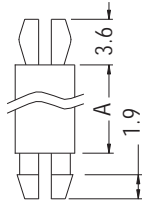

P.C.B Ø4.0
THICKNESS 1.6

P.C.B Ø3.9
THICKNESS 1.6

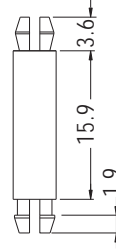

P.C.B Ø3.9
THICKNESS 1.6

FOR MSP-15.9S

PARTNO	A	PACKAGE
MSP-3	3.2	1000
MSP-4	4.0	
MSP-4.5	4.5	
MSP-5	5.0	
MSP-6	6.3	
MSP-7	7.0	
MSP-8	8.0	
MSP-9	9.5	
MSP-10	10.5	
MSP-12	12.7	
MSP-14	14.0	
MSP-15	15.9	
MSP-15.9S	19.0	
MSP-19	19.0	
MSP-22	22.0	

SPACER SUPPORT

- ◆ MATERIAL: NYLON 66 (UL)
- ◆ FLAME CLASS: 94V-2/94V-0
- ◆ COLOR: NATURAL/BLACK
- ◆ UNIT: mm



P.C.B Ø4.0
THICKNESS 1.6

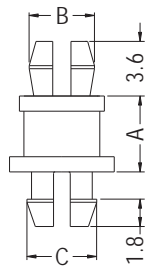

P.C.B Ø4.0
THICKNESS 1.6

PARTNO	A	B	C	PACKAGE
DMSPS-5	5.0	4.3	4.6	1000
DMSPS-7.9	7.9	4.3	4.6	
DMSPS-12.7	12.7	4.3	4.6	
DMSPS-17.5	17.5	4.3	4.6	
DMSPS-17.5S	17.5	4.2	4.25	

SPACER SUPPORT

- ◆ MATERIAL: NYLON 66 (UL)
- ◆ FLAME CLASS: 94V-2/94V-0
- ◆ COLOR: NATURAL/BLACK
- ◆ UNIT: mm



P.C.B Ø4.0
THICKNESS 1.6

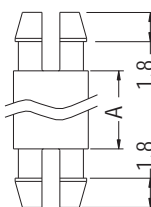

P.C.B Ø4.0
THICKNESS 1.6

PARTNO	A	PACKAGE
DMSP-4.8	4.8	1000
DMSP-6.4	6.4	
DMSP-11.1	11.1	



SPACER SUPPORT



- ◆ MATERIAL: NYLON 66 (UL)
- ◆ FLAME CLASS: 94V-2/94V-0
- ◆ COLOR: NATURAL/BLACK
- ◆ UNIT: mm

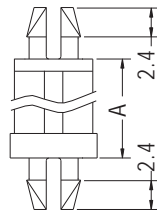

P.C.B Ø4.0
THICKNESS 1.6

P.C.B Ø4.0
THICKNESS 1.6

PART NO	A	PACKAGE
MSPM-5	4.8	1000
MSPM-2.4	23.8	

SPACERSUPPORT



- ◆ MATERIAL: NYLON 66 (UL)
- ◆ FLAME CLASS: 94V-2/94V-0
- ◆ COLOR: NATURAL/BLACK
- ◆ UNIT: mm

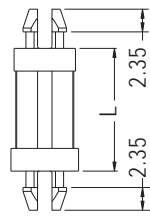

P.C.B Ø4.0
THICKNESS 1.6

P.C.B Ø4.0
THICKNESS 1.6

PART NO	L	PACKAGE
MSP1-6.4	6.4	1000
MSP1-9.5	9.5	
MSP1-10	10.0	
MSP1-12.7	12.7	
MSP1-15.9	15.9	
MSP1-19.1	19.1	
MSP1-22.2	22.2	
MSP1-25.4	25.4	

SPACER SUPPORT



- ◆ MATERIAL: NYLON 66 (UL)
- ◆ FLAME CLASS: 94V-2/94V-0
- ◆ COLOR: NATURAL/BLACK
- ◆ UNIT: mm

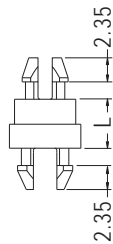

P.C.B Ø4.0
THICKNESS 1.6

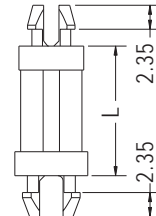

P.C.B Ø4.8
THICKNESS 1.6

PART NO	L	PACKAGE
MSPK45-4.8	4.8	2000
MSPK45-6.4	6.4	
MSPK45-9.5	9.5	
MSPK45-12.7	12.7	1000
MSPK45-15.9	15.9	
MSPK45-19.1	19.1	
MSPK45-22.2	22.2	
MSPK45-25.4	25.4	

FOR MSPK45-4.8

SPACERSUPPORT



- ◆ MATERIAL: NYLON 66 (UL)
- ◆ FLAME CLASS: 94V-2/94V-0
- ◆ COLOR: NATURAL/BLACK
- ◆ UNIT: mm

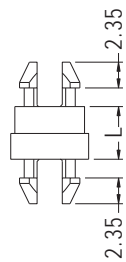

FOR MSPK4.8-4.8

P.C.B Ø4.8
THICKNESS 1.6

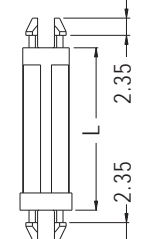

P.C.B Ø4.8
THICKNESS 1.6

PART NO	L	PACKAGE
MSPK4.8-4.8	4.8	2000
MSPK4.8-6.4	6.4	
MSPK4.8-9.5	9.5	
MSPK4.8-12.7	12.7	1000
MSPK4.8-15.9	15.9	
MSPK4.8-19.1	19.1	
MSPK4.8-22.2	22.2	
MSPK4.8-25.4	25.4	
MSPK4.8-31.7	31.75	



SPACER SUPPORT



- ◆ MATERIAL: NYLON 66 (UL)
 - ◆ FLAME CLASS: 94V-2/94V-0
 - ◆ COLOR: NATURAL/BLACK
 - ◆ UNIT: mm
- P.C.B Ø3.0
THICKNESS 1.6
-
- P.C.B Ø3.0
THICKNESS 1.6

PART NO	PACKAGE
SSDU1-3.5	1000

SPACERSUPPORT



- ◆ MATERIAL: NYLON 66 (UL)
 - ◆ FLAME CLASS: 94V-2/94V-0
 - ◆ COLOR: NATURAL/BLACK
 - ◆ UNIT: mm
- P.C.B Ø4.0
THICKNESS 1.6
-
- P.C.B Ø4.0
THICKNESS 1.6

PART NO	PACKAGE
DMSA-9	1000

SPACER SUPPORT



- ◆ MATERIAL: NYLON 66 (UL)
 - ◆ FLAME CLASS: 94V-2/94V-0
 - ◆ COLOR: NATURAL/BLACK
 - ◆ UNIT: mm
- P.C.B Ø5.2
THICKNESS: E
-
- P.C.B Ø5.2
THICKNESS: F

PART NO	A	B	C	E	F	PACKAGE
SSDU-9.2	9.2	1.55	1.55	1.6	1.6	1000
SSDU-9.6	9.6	1.85	1.85	1.2	1.2	

SPACERSUPPORT



- ◆ MATERIAL: NYLON 66 (UL)
 - ◆ FLAME CLASS: 94V-2/94V-0
 - ◆ COLOR: NATURAL/BLACK
 - ◆ UNIT: mm
-
- P.C.B Ø3.2
THICKNESS 1.6

PART NO	PACKAGE
MSPE-7	1000



SPACER SUPPORT

- ◆ MATERIAL: NYLON 66 (UL)
- ◆ FLAME CLASS: 94V-2/94V-0
- ◆ COLOR: NATURAL/BLACK
- ◆ UNIT: mm

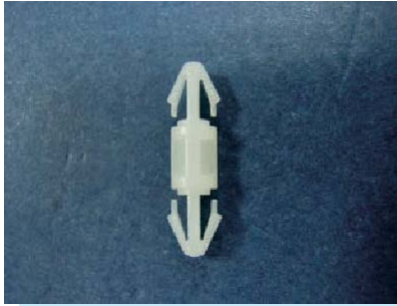

P.C.B Ø3.0
THICKNESS: E

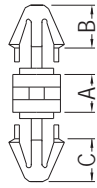

PART NO	A	B	C	E	F	PACKAGE
LCV-3	3.0	3.55	3.55	1.6	1.6	1000
LCV-5	5.0	3.4	3.4	1.8	1.8	
LCV-6	6.0	3.6	3.6	1.2~1.7	0.8~1.0	

P.C.B Ø3.0
THICKNESS: F



P.C.B Ø3.0
THICKNESS: E

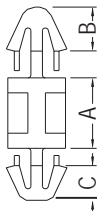

PART NO	A	B	C	E	F	PACKAGE
LCVA-2	2.0	3.1	2.4	1.6	0.8~1.0	2000
LCVA-2.5	2.5	3.0	2.4	0.8~1.0	1.6	
LCVA-4	4.0	3.1	2.4	1.6	0.8~1.0	
LCVA-5	5.0	3.1	2.4	1.6	0.8~1.0	

CHASSIS Ø3.0
THICKNESS: F



P.C.B Ø3.0
THICKNESS: E

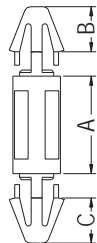

PART NO	A	B	C	E	F	PACKAGE
LCVU-8	8.0	3.7	3.7	1.2~1.8	1.2~1.8	1000
LCVU-9	9.0	3.55	3.55	2.0	2.0	
LCVU-10	10.0	3.7	3.7	1.2~1.8	1.2~1.8	

P.C.B Ø3.0
THICKNESS: F

SPACER SUPPORT

- ◆ MATERIAL: NYLON 66 (UL)
- ◆ FLAME CLASS: 94V-2/94V-0
- ◆ COLOR: NATURAL/BLACK
- ◆ UNIT: mm



P.C.B Ø3.0
THICKNESS 1.2~1.7

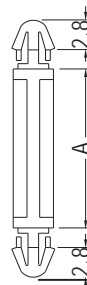

PART NO	A	PACKAGE
LCJ-15	15.0	1000
LCJ-19	19.0	
LCJ-21	21.0	

P.C.B Ø3.0
THICKNESS 1.2~1.7



SPACER SUPPORT

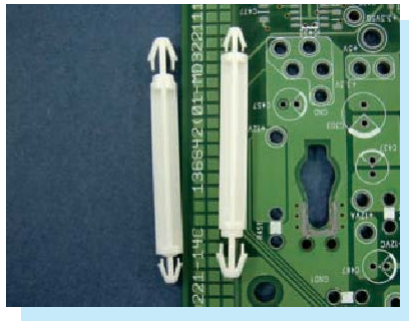

- ◆ MATERIAL: NYLON 66 (UL)
- ◆ FLAME CLASS: 94V-2/94V-0
- ◆ COLOR: NATURAL/BLACK
- ◆ UNIT: mm

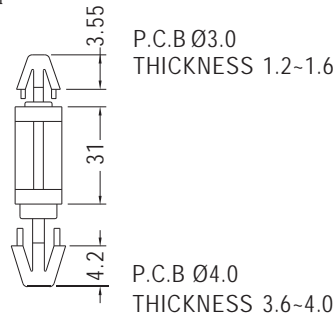

PART NO	PACKAGE
LCX-31	2000

SPACER SUPPORT

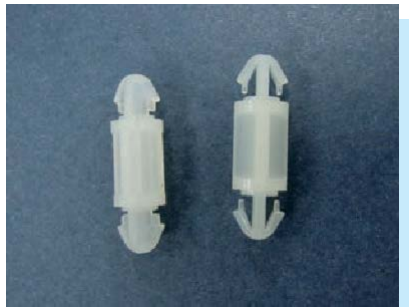

- ◆ MATERIAL: NYLON 66 (UL)
- ◆ FLAME CLASS: 94V-2/94V-0
- ◆ COLOR: NATURAL/BLACK
- ◆ UNIT: mm

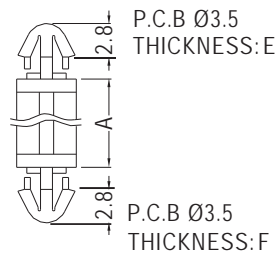

PART NO	A	E	F	PACKAGE
LCI-2.5	2.5	1.2~1.7	1.2~1.7	2000
LCI-3	3.0			
LCI-3.5	3.5			
LCI-4	4.0			
LCI-4.5	4.5			
LCI-5	5.0			

PART NO	A	E	F	PACKAGE
LCI-5.5	5.5	1.2~1.7	1.2~1.7	1000
LCI-6	6.0			
LCI-6.5	6.35			
LCI-7	7.0			
LCI-8	8.0			
LCI-9	9.0			
LCI-10	10.0			
LCI-11	11.0			
LCI-12	12.0			
LCI-15	15.0			
LCI-15(2)	15.0	1.6~2.4	1.6~2.4	500
LCI-20	20.0	1.2~1.7	1.2~1.7	
★LCI-30L	30.0	1.6~2.4	1.6~2.4	

SPACER SUPPORT



- ◆ MATERIAL: NYLON 66 (UL)
- ◆ FLAME CLASS: 94V-2/94V-0
- ◆ COLOR: NATURAL/BLACK
- ◆ UNIT: mm

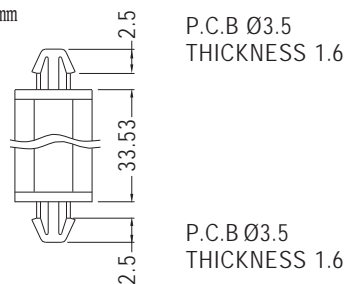

PART NO	PACKAGE
LDE-33	1000

SPACER SUPPORT



- ◆ MATERIAL: NYLON 66 (UL)
- ◆ FLAME CLASS: 94V-2/94V-0
- ◆ COLOR: NATURAL/BLACK
- ◆ UNIT: mm

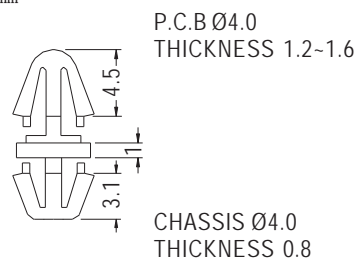

PART NO	PACKAGE
LCK-1	2000



SPACER SUPPORT

- ◆ MATERIAL:NYLON 66 (UL)
- ◆ FLAME CLASS:94V-2/94V-0
- ◆ COLOR:NATURAL/BLACK
- ◆ UNIT:mm



P.C.B Ø4.0
THICKNESS 1.2-1.7

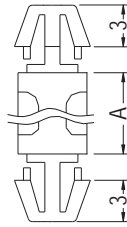

P.C.B Ø4.0
THICKNESS 1.2-1.7

PARTNO	A	PACKAGE
LCC-3S	3.0	2000
LCC-3	3.5	
LCC-4	4.0	
LCC-5	5.0	
LCC-6S	6.0	
LCC-6	6.4	
LCC-7	7.0	
LCC-8	8.0	
LCC-9.5	9.5	
LCC-10S	10.0	
LCC-10	10.5	1000
LCC-11.5	11.5	
LCC-12S	12.0	
LCC-12	12.7	
LCC-14	14.0	

PARTNO	A	PACKAGE
LCC-15	15.9	1000
LCC-18	18.0	
LCC-19	19.0	
LCC-20	20.0	
LCC-25	25.0	
LCC-25.4	25.4	
LCC-27	27.0	
LCC-30	30.0	
LCC-34	34.0	
LCC-40	40.0	
LCC-55	55.0	500
LCC-69	69.0	
LCC-71	71.2	
LCC-72	72.0	
LCC-74	74.2	
LCC-80	80.0	

SPACER SUPPORT

- ◆ MATERIAL:NYLON 66 (UL)
- ◆ FLAME CLASS:94V-2/94V-0
- ◆ COLOR:NATURAL/BLACK
- ◆ UNIT:mm

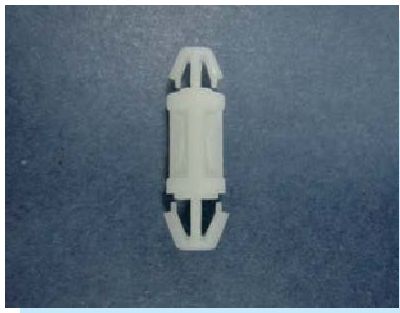

P.C.B Ø4.0
THICKNESS 1.6

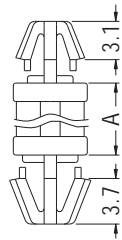

CHASSIS Ø4.8
THICKNESS 1.6

PARTNO	A	PACKAGE
LCBM-3	3.0	1000
LCBM-4	4.0	
LCBM-6	6.0	
LCBM-8	8.0	
LCBM-10	10.0	
LCBM-12	12.0	
LCBM-14	14.0	
LCBM-16	16.0	
LCBM-18	18.0	

SPACER SUPPORT

- ◆ MATERIAL:NYLON 66 (UL)
- ◆ FLAME CLASS:94V-2/94V-0
- ◆ COLOR:NATURAL/BLACK
- ◆ UNIT:mm



P.C.B Ø2.6
THICKNESS 1.0

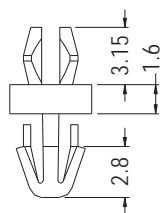

P.C.B Ø2.8
THICKNESS 1.6

PARTNO	PACKAGE
MSPA-1.6	2000



SPACER SUPPORT

NEW



- ◆ MATERIAL: NYLON 66 (UL)
- ◆ FLAME CLASS: 94V-2/94V-0
- ◆ COLOR: NATURAL/BLACK
- ◆ UNIT: mm

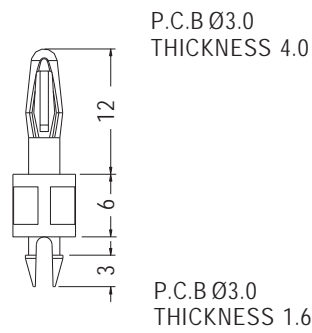

PART NO	PACKAGE
LMSA-6	1000

1

SPACER SUPPORT



- ◆ MATERIAL: NYLON 66 (UL)
- ◆ FLAME CLASS: 94V-2/94V-0
- ◆ COLOR: NATURAL/WHITE/BLACK
- ◆ UNIT: mm

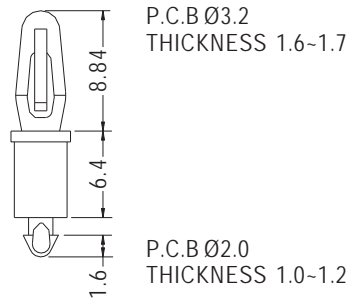

PART NO	PACKAGE
LCPL-6.4	1000

SPACER SUPPORT

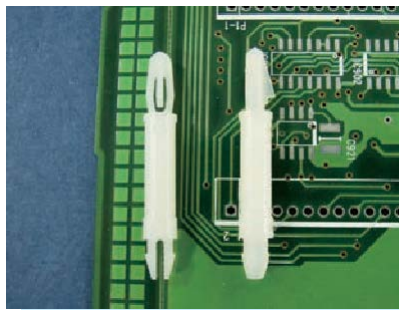

- ◆ MATERIAL: NYLON 66 (UL)
- ◆ FLAME CLASS: 94V-2/94V-0
- ◆ COLOR: NATURAL/BLACK
- ◆ UNIT: mm

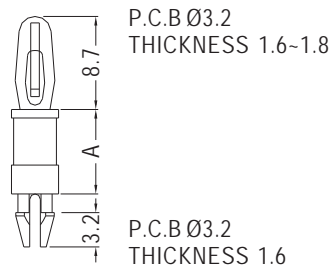

PART NO	A	PACKAGE
LMSP-8	7.9	1000
LMSP-16	15.9	

SPACERSUPPORT



- ◆ MATERIAL: NYLON 66 (UL)
- ◆ FLAME CLASS: 94V-2/94V-0
- ◆ COLOR: NATURAL/BLACK
- ◆ UNIT: mm

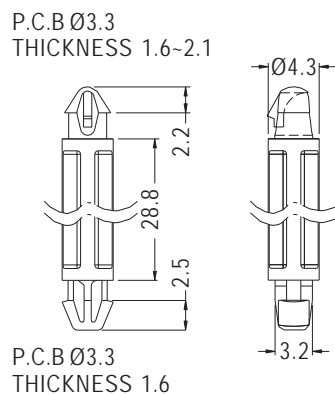

PART NO	PACKAGE
LCOA-28.8	1000



SPACERSUPPORT



- ◆ MATERIAL: NYLON 66 (UL)
- ◆ FLAME CLASS: 94V-2/94V-0
- ◆ COLOR: NATURAL/BLACK
- ◆ UNIT: mm

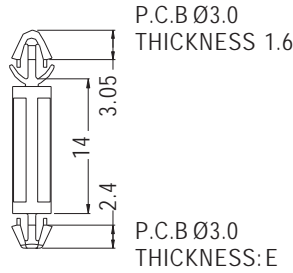

PARTNO	E	PACKAGE
LCGA-14	0.8-1.0	1000
LCGA-14S	0.6	

SPACER SUPPORT

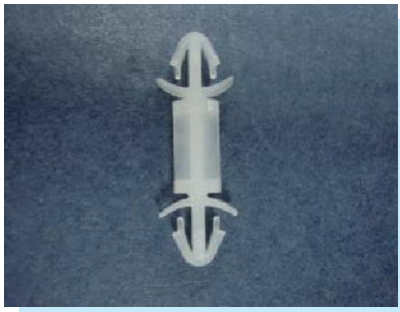

- ◆ MATERIAL: NYLON 66 (UL)
- ◆ FLAME CLASS: 94V-2/94V-0
- ◆ COLOR: NATURAL/BLACK
- ◆ UNIT: mm

P.C.B Ø3.0
THICKNESS 1.2-2.0

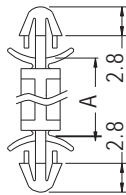

P.C.B Ø3.0
THICKNESS 1.2-2.0

PARTNO	A	PACKAGE
LCF-3	3.2	1000
LCF-4	4.0	
LCF-5	5.0	
LCF-6	6.35	
LCF-7	7.0	
LCF-8	8.0	
LCF-9	9.5	

PARTNO	A	PACKAGE
LCF-11	11.2	1000
LCF-12	12.0	
LCF-15	15.0	
LCF-16	16.0	
LCF-17	17.0	
LCF-20	20.2	
LCF-22	22.0	
LCF-25	25.4	

SPACER SUPPORT

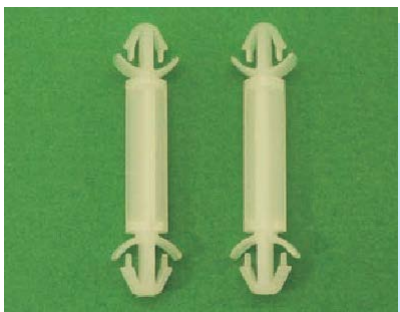

- ◆ MATERIAL: NYLON 66 (UL)
- ◆ FLAME CLASS: 94V-2/94V-0
- ◆ COLOR: NATURAL/BLACK
- ◆ UNIT: mm

P.C.B Ø3.0
THICKNESS 1.2-2.0

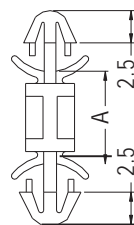

CHASSIS Ø3.5
THICKNESS 1.6-2.0

PARTNO	A	PACKAGE
LCFO-3	3.0	2000
LCFO-3.5	3.5	
LCFO-4	4.0	
LCFO-4.8	4.8	
LCFO-6	6.0	
LCFO-6.4	6.4	
LCFO-7	7.0	

PARTNO	A	PACKAGE
LCFO-8	8.0	2000
LCFO-9	9.0	
LCFO-10	10.0	
LCFO-11.5	11.5	
LCFO-12.7	12.7	
LCFO-14	14.0	
LCFO-16	16.0	

SPACERSUPPORT



- ◆ MATERIAL: NYLON 66 (UL)
- ◆ FLAME CLASS: 94V-2/94V-0
- ◆ COLOR: NATURAL/BLACK
- ◆ UNIT: mm

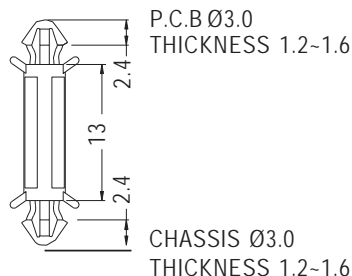

PARTNO	PACKAGE
CBSA-13	1000



SPACER SUPPORT



- ◆ MATERIAL: NYLON 66 (UL)
- ◆ FLAME CLASS: 94V-2/94V-0
- ◆ COLOR: NATURAL/BLACK
- ◆ UNIT: mm

P.C.B Ø3.5
THICKNESS 1.6-2.0

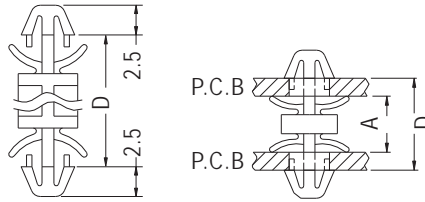

P.C.B Ø3.5
THICKNESS 1.6-2.0 FOR LCO-5-LCO-8

PART NO	A	D	PACKAGE
LCO-5	5.0	8.2	1000
LCO-6.4	6.4	9.6	
LCO-8	8.0	11.2	
LCO-10	10.0	13.2	
LCO-11	11.0	14.2	
LCO-12.7	12.7	15.9	
LCO-15.9	15.9	19.1	



SPACER SUPPORT



- ◆ MATERIAL: NYLON 66 (UL)
- ◆ FLAME CLASS: 94V-2/94V-0
- ◆ COLOR: NATURAL/BLACK
- ◆ UNIT: mm

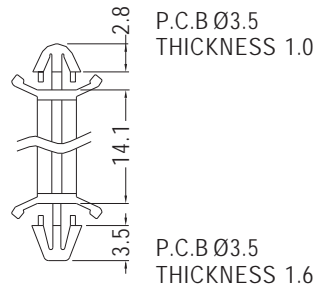

P.C.B Ø3.5
THICKNESS 1.0

P.C.B Ø3.5
THICKNESS 1.6

PART NO	PACKAGE
CBCS-14	1000

SPACER SUPPORT



- ◆ MATERIAL: NYLON 66 (UL)
- ◆ FLAME CLASS: 94V-2/94V-0
- ◆ COLOR: NATURAL/BLACK
- ◆ UNIT: mm

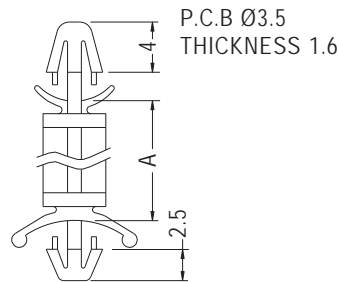

P.C.B Ø3.5
THICKNESS 1.6

CHASSIS Ø3.5
THICKNESS 0.8-2.0

PART NO	A	PACKAGE
LCD-3	3.2	2000
LCD-4	4.0	
LCD-5	4.8	1000
LCD-6	6.4	
LCD-7	7.0	
LCD-8	8.0	
LCD-9	9.6	
LCD-11	11.2	
LCD-12	12.7	
LCD-14	14.0	
LCD-16	16.0	
LCD-18	18.0	
LCD-19	19.1	
LCD-27	27.5	

SPACER SUPPORT

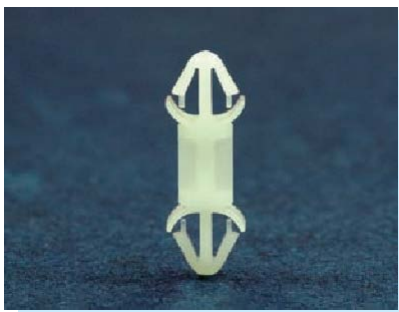

- ◆ MATERIAL: NYLON 66 (UL)
- ◆ FLAME CLASS: 94V-2/94V-0
- ◆ COLOR: NATURAL/BLACK
- ◆ UNIT: mm

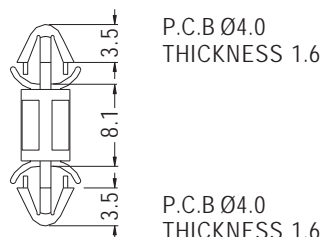

P.C.B Ø4.0
THICKNESS 1.6

P.C.B Ø4.0
THICKNESS 1.6

PART NO	PACKAGE
LCFB-8	1000



SPACER SUPPORT



- ◆ MATERIAL: NYLON 66 (UL)
- ◆ FLAME CLASS: 94V-2/94V-0
- ◆ COLOR: NATURAL/BLACK
- ◆ UNIT: mm

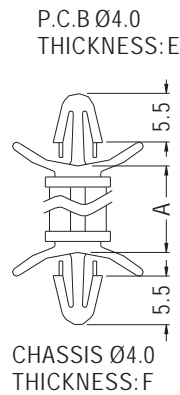

PARTNO	A	E	F	PACKAGE
LCEO-5	4.8	0.8-2.0	0.8-2.0	1000
LCEO-6	6.4			
LCEO-8	7.9			
LCEO-9	9.5			
LCEO-12	12.7			
LCEO-12L	11.9	1.2-2.3	1.2-2.3	
LCEO-15	15.9	0.8-2.0	0.8-2.0	
LCEO-19	19.0			
LCEO-22	22.2			

SPACER SUPPORT

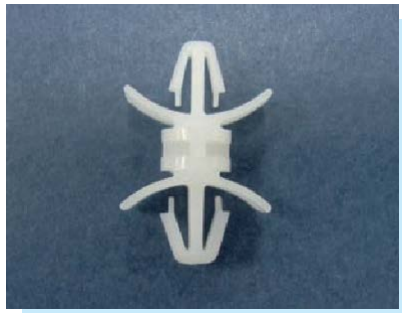

- ◆ MATERIAL: NYLON 66 (UL)
- ◆ FLAME CLASS: 94V-2/94V-0
- ◆ COLOR: NATURAL/BLACK
- ◆ UNIT: mm

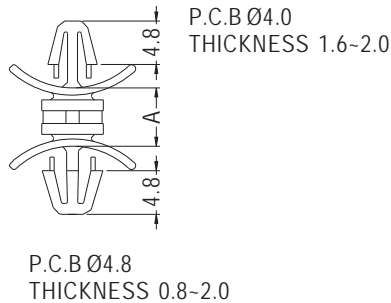

PARTNO	A	PACKAGE
LCBZ-4.8	4.8	1000
LCBZ-6.4	6.4	

SPACER SUPPORT



- ◆ MATERIAL: NYLON 66 (UL)
- ◆ FLAME CLASS: 94V-2/94V-0
- ◆ COLOR: NATURAL/BLACK
- ◆ UNIT: mm

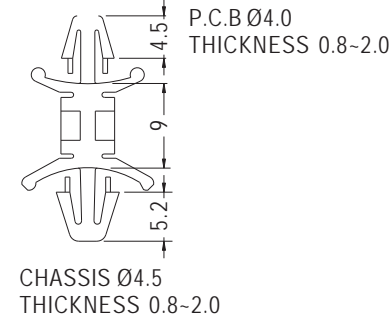

PARTNO	PACKAGE
LCT-9	1000

SPACER SUPPORT



- ◆ MATERIAL: NYLON 66 (UL)
- ◆ FLAME CLASS: 94V-2/94V-0
- ◆ COLOR: NATURAL/BLACK
- ◆ UNIT: mm

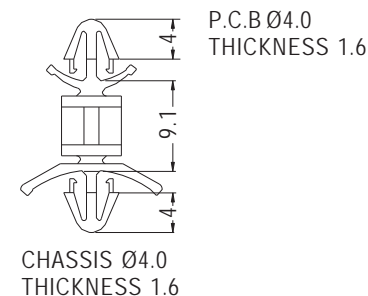

PARTNO	PACKAGE
LCBJ-9	1000

SPACER SUPPORT



- ◆ MATERIAL: NYLON 66 (UL)
- ◆ FLAME CLASS: 94V-2/94V-0
- ◆ COLOR: NATURAL/BLACK
- ◆ UNIT: mm

CHASSIS Ø4.8
THICKNESS 0.8-2.0

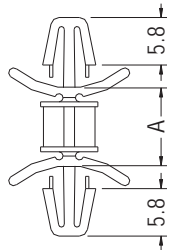

CHASSIS Ø4.8
THICKNESS 0.8-2.0

CHASSIS Ø4.8
THICKNESS 0.8-2.0

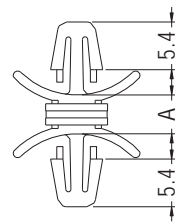

CHASSIS Ø4.8
THICKNESS 0.8-2.0
FOR LCBYR-4.8

PART NO	A	PACKAGE
LCBY-4.8	4.8	1000
LCBY-6.4	6.4	
LCBY-9.5	9.5	
LCBY-12.7	12.7	
LCBY-15.9	15.9	
LCBY-19.1	19.1	
LCBY-22.2	22.2	

PART NO	A	PACKAGE
LCBYR-4.8	4.4	1000

SPACERSUPPORT

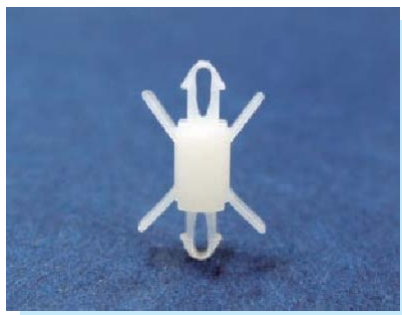

- ◆ MATERIAL: NYLON 66 (UL)
- ◆ FLAME CLASS: 94V-2/94V-0
- ◆ COLOR: NATURAL/BLACK
- ◆ UNIT: mm

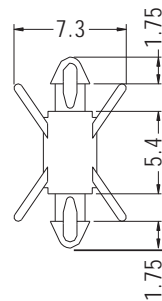

P.C.B Ø2.0
THICKNESS 0.8-1.6

P.C.B Ø2.0
THICKNESS 0.8-1.6

PART NO	PACKAGE
MADG-5.4	2000

SPACER SUPPORT

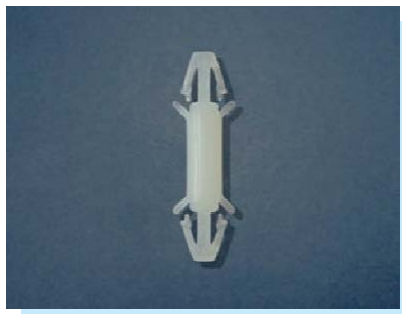

- ◆ MATERIAL: NYLON 66 (UL)
- ◆ FLAME CLASS: 94V-2/94V-0
- ◆ COLOR: NATURAL/BLACK
- ◆ UNIT: mm

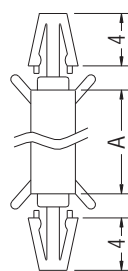

P.C.B Ø3.0
THICKNESS 1.6

P.C.B Ø3.0
THICKNESS 1.6

PART NO	A	PACKAGE
LCA-6	6.3	1000
LCA-8	8.0	
LCA-10	10.0	
LCA-12	12.7	

SPACER SUPPORT



- ◆ MATERIAL: NYLON 66 (UL)
- ◆ FLAME CLASS: 94V-2/94V-0
- ◆ COLOR: NATURAL/BLACK
- ◆ UNIT: mm

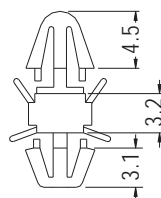

P.C.B Ø4.0
THICKNESS 1.6

CHASSIS Ø4.0
THICKNESS 0.8

PART NO	PACKAGE
LCL-3.2	2000



SPACER SUPPORT

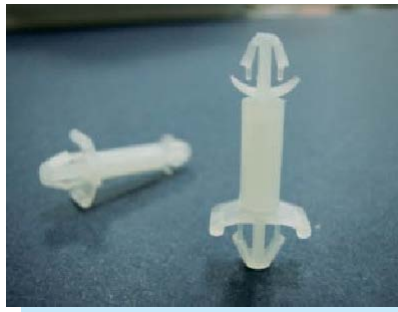

- ◆ MATERIAL: NYLON 66 (UL)
- ◆ FLAME CLASS: 94V-2/94V-0
- ◆ COLOR: NATURAL/BLACK
- ◆ UNIT: mm

P.C.B Ø3.0
THICKNESS 0.8-2.0

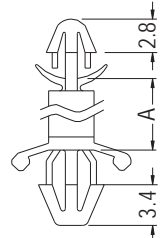

CHASSIS Ø4.0
THICKNESS 1.2-2.6

PART NO	A	PACKAGE
LCH-3	3.5	2000
LCH-4	4.0	
LCH-5	5.0	
LCH-6	6.3	1000
LCH-7	7.4	
LCH-8	8.5	
LCH-10	10.0	
LCH-11	11.0	
LCH-12	12.7	
LCH-15	15.9	

SPACER SUPPORT



- ◆ MATERIAL: NYLON 66 (UL)
- ◆ FLAME CLASS: 94V-2/94V-0
- ◆ COLOR: NATURAL/BLACK
- ◆ UNIT: mm

P.C.B Ø3.5
THICKNESS 0.8-2.0

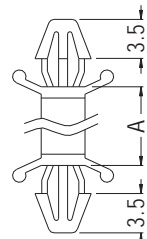

P.C.B Ø3.5
THICKNESS 0.8-2.0

PART NO	A	PACKAGE
CBSS-2	2.1	2000
CBSS-2.2	2.2	
CBSS-4.8	4.8	
CBSS-7	7.0	
CBSS-10	10.0	
CBSS-12.7	12.7	
CBSS-14	14.0	
CBSS-17	17.0	

SPACER SUPPORT

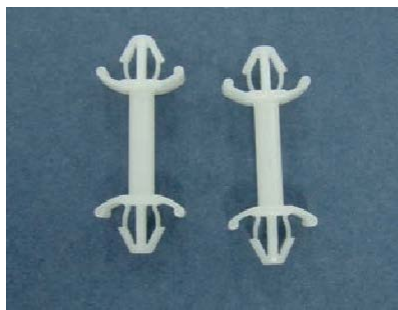

- ◆ MATERIAL: NYLON 66 (UL)
- ◆ FLAME CLASS: 94V-2/94V-0
- ◆ COLOR: NATURAL/BLACK
- ◆ UNIT: mm

P.C.B Ø4.0
THICKNESS 1.6

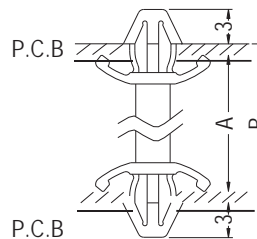

P.C.B Ø4.0
THICKNESS 1.6

PART NO	A	B	PACKAGE
CBLSS-6	6.0	9.2	1000
CBLSS-8	8.0	11.2	
CBLSS-10	10.0	13.2	
CBLSS-12	12.0	15.2	
CBLSS-13	13.0	16.2	
CBLSS-14	14.0	17.2	
CBLSS-16	16.0	19.2	
CBLSS-16.8	16.8	20.0	
CBLSS-18	18.0	21.2	
CBLSS-20	20.0	23.2	
CBLSS-42	42.0	45.2	

SPACER SUPPORT



- ◆ MATERIAL: NYLON 66 (UL)
- ◆ FLAME CLASS: 94V-2/94V-0
- ◆ COLOR: NATURAL/BLACK
- ◆ UNIT: mm

P.C.B Ø4.0
THICKNESS 1.6

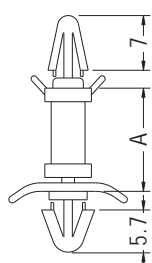

CHASSIS Ø4.8
THICKNESS 0.8-2.0

PART NO	A	PACKAGE
LCB-5	5.0	1000
LCB-6	6.3	
LCB-8	8.0	
LCB-10	10.0	
LCB-12	12.7	
LCB-15	15.9	
LCB-20	20.0	
LCB-25	25.0	



SPACER SUPPORT

- ◆ MATERIAL: NYLON 66 (UL)
- ◆ FLAME CLASS: 94V-2/94V-0
- ◆ COLOR: NATURAL/BLACK
- ◆ UNIT: mm

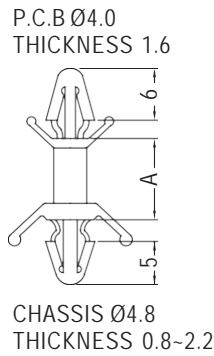

PARTNO	A	PACKAGE
CBS-3.8	3.8	1000
CBS-5	4.6	
CBS-6	6.3	
CBS-8	7.93	
CBS-9	9.2	
CBS-12	12.5	
CBS-15	15.7	
CBS-19	19.0	
CBS-22	22.0	
CBS-25	25.4	
CBS-28	28.6	

SPACER SUPPORT

- ◆ MATERIAL: NYLON 66 (UL)
- ◆ FLAME CLASS: 94V-2/94V-0
- ◆ COLOR: NATURAL/BLACK
- ◆ UNIT: mm

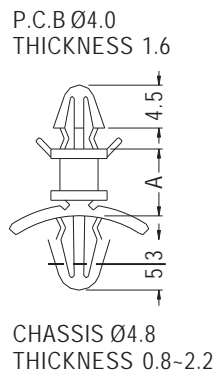

PARTNO	A	PACKAGE
LCBS-4	4.0	1000
LCBS-5	5.0	
LCBS-6	6.35	
LCBS-7	7.0	
LCBS-9	9.2	
LCBS-10	10.0	
LCBS-12	12.5	
LCBS-15	15.7	
LCBS-19	19.0	

PARTNO	A	PACKAGE
LCBS-20	20.0	500
LCBS-22	22.0	
LCBS-25	25.4	
LCBS-28	28.6	
LCBS-30	30.0	
LCBS-35	35.0	
LCBS-38	38.0	
LCBS-45	45.0	

SPACER SUPPORT

- ◆ MATERIAL: NYLON 66 (UL)
- ◆ FLAME CLASS: 94V-2/94V-0
- ◆ COLOR: NATURAL/BLACK
- ◆ UNIT: mm

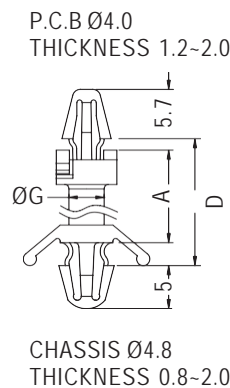

PART NO	A	D	G	PACKAGE
VCBS-9	5.9	9.8		1000
VCBS-11	7.5	11.4	4.0	
VCBS-14	10.5	14.4	4.0	
VCBS-16	12.7	16.6	4.0	
VCBS-17	13.8	17.7	4.0	
VCBS-20	17.0	20.9	4.0	
VCBS-24	20.2	24.1	4.5	
VCBS-27	23.3	27.2	4.5	
VCBS-30	26.5	30.4	4.5	
VCBS-33	29.7	33.6	4.5	
VCBS-39	36.0	39.9	4.5	



SPACER SUPPORT

- ◆ MATERIAL: NYLON 66 (UL)
- ◆ FLAME CLASS: 94V-2/94V-0
- ◆ COLOR: NATURAL/BLACK
- ◆ UNIT: mm

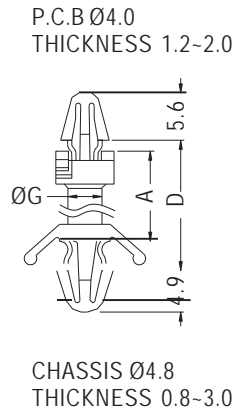
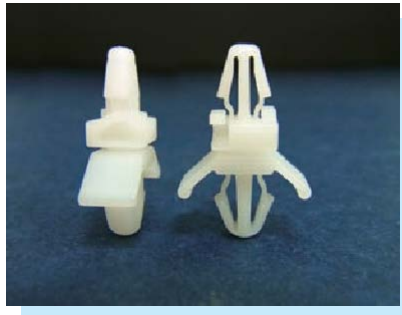

PARTNO	A	D	G	PACKAGE
VCBSL-9	5.0	9.8		1000
VCBSL-11	6.6	11.4	4.0	
VCBSL-14	9.6	14.4	4.0	
VCBSL-16	11.8	16.6	4.0	
VCBSL-17	12.9	17.7	4.0	
VCBSL-24	19.3	24.1	4.5	
VCBSL-27	22.4	27.2	4.5	
VCBSL-30	25.6	30.4	4.5	
VCBSL-33	28.8	33.6	4.5	
VCBSL-39	35.1	39.9	4.5	

SPACER SUPPORT

- ◆ MATERIAL: NYLON 66 (UL)
- ◆ FLAME CLASS: 94V-2/94V-0
- ◆ COLOR: NATURAL/BLACK
- ◆ UNIT: mm

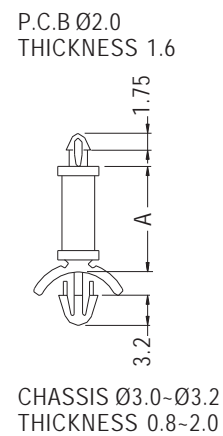

PART NO	A	PACKAGE
LCMA-3.2	3.2	1000
LCMA-4.8	4.8	
LCMA-6.4	6.4	
LCMA-7.9	7.9	
LCMA-9.5	9.5	
LCMA-11.1	11.1	
LCMA-12.7	12.7	
LCMA-14.3	14.3	
LCMA-15.9	15.9	
LCMA-17	17.0	

SPACER SUPPORT

- ◆ MATERIAL: NYLON 66 (UL)
- ◆ FLAME CLASS: 94V-2/94V-0
- ◆ COLOR: NATURAL/BLACK
- ◆ UNIT: mm

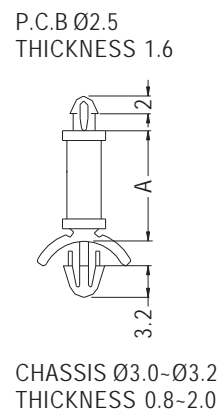

PARTNO	A	PACKAGE
LCMD-3.2	3.2	1000
LCMD-4.8	4.8	
LCMD-6.4	6.4	
LCMD-7.9	7.9	
LCMD-9.5	9.5	
LCMD-11.1	11.1	
LCMD-12.7	12.7	
LCMD-14.3	14.3	
LCMD-15.9	15.9	
LCMD-17	17.0	



SPACER SUPPORT



- ◆ MATERIAL: NYLON 66 (UL)
- ◆ FLAME CLASS: 94V-2/94V-0
- ◆ COLOR: NATURAL/BLACK
- ◆ UNIT: mm

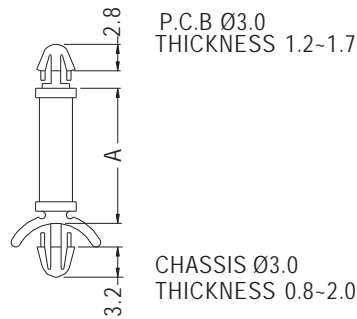

PART NO	A	PACKAGE
LCG-3	3.2	1000
LCG-5	4.8	
LCG-6	6.4	
LCG-8	7.9	
LCG-9	9.5	
LCG-11	11.1	
LCG-12	12.7	
LCG-14	14.3	
LCG-15	15.9	
LCG-17	17.0	
LCG-18	18.0	
LCG-19	19.0	
★ LCG-20	20.0	
★ LCG-26	26.0	

SPACER SUPPORT



- ◆ MATERIAL: NYLON 66 (UL)
- ◆ FLAME CLASS: 94V-2/94V-0
- ◆ COLOR: NATURAL/BLACK
- ◆ UNIT: mm

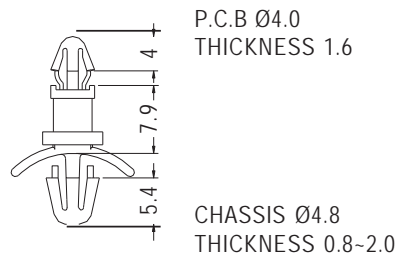

PART NO	PACKAGE
LCBC-8	1000

SPACER SUPPORT

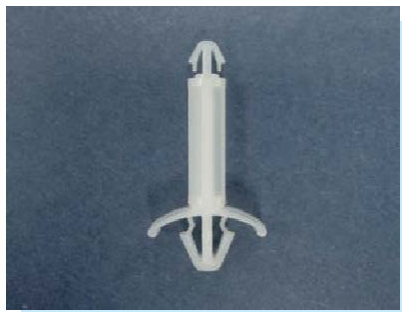

- ◆ MATERIAL: NYLON 66 (UL)
- ◆ FLAME CLASS: 94V-2/94V-0
- ◆ COLOR: NATURAL/BLACK
- ◆ UNIT: mm

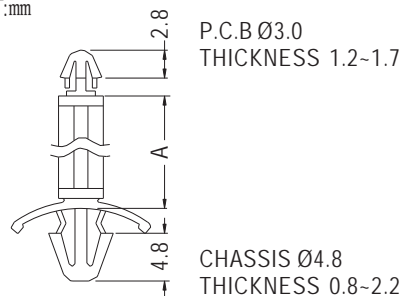

PART NO	A	PACKAGE
LCBT-3	3.2	1000
LCBT-5	4.8	
LCBT-6	6.3	
LCBT-8	8.0	
LCBT-10	10.0	
LCBT-12	12.0	
LCBT-14	14.0	
LCBT-16	16.0	
LCBT-18	18.0	
LCBT-25	25.0	

SPACER SUPPORT



- ◆ MATERIAL: NYLON 66 (UL)
- ◆ FLAME CLASS: 94V-2/94V-0
- ◆ COLOR: NATURAL/BLACK
- ◆ UNIT: mm

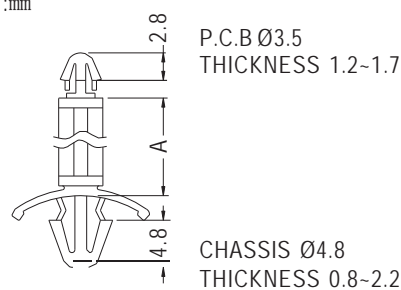

PART NO	A	PACKAGE
LCBU-3	3.2	1000
LCBU-5	5.0	
LCBU-6	6.3	
LCBU-8	8.0	
LCBU-10	10.0	
LCBU-12	12.0	
LCBU-14	14.0	
LCBU-16	16.0	
LCBU-18	18.0	
LCBU-25	25.0	



SPACERSUPPORT

- ◆ MATERIAL: NYLON 66 (UL)
- ◆ FLAME CLASS: 94V-2/94V-0
- ◆ COLOR: NATURAL/BLACK
- ◆ UNIT: mm

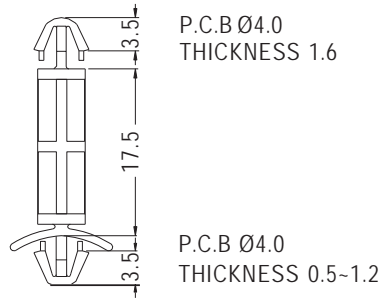

PART NO	PACKAGE
LCGB-17.5	1000

1

SPACERSUPPORT

- ◆ MATERIAL: NYLON 66 (UL)
- ◆ FLAME CLASS: 94V-2/94V-0
- ◆ COLOR: NATURAL/BLACK
- ◆ UNIT: mm

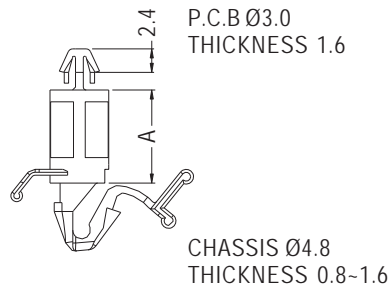
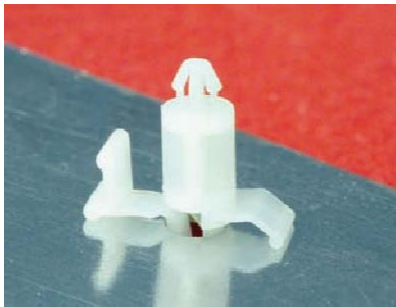

PART NO	A	PACKAGE
KLCBS-9.5	9.5	1000
KLCBS-12.7	12.7	
KLCBS-15.9	15.9	
KLCBS-19.1	19.1	

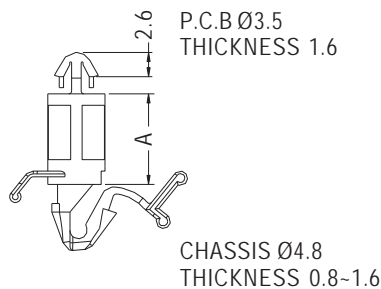

PART NO	A	PACKAGE
KLCBM-9.5	9.5	1000
KLCBM-12.7	12.7	
KLCBM-15.9	15.9	
KLCBM-19.1	19.1	

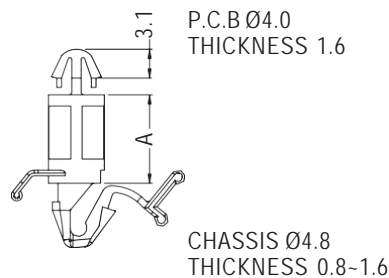

PART NO	A	PACKAGE
KLCBL-9.5	9.5	1000
KLCBL-12.7	12.7	
KLCBL-15.9	15.9	
KLCBL-19.1	19.1	



SPACER SUPPORT

NEW

- ◆ MATERIAL: NYLON 66 (UL)
- ◆ FLAME CLASS: 94V-2/94V-0
- ◆ COLOR: NATURAL/BLACK
- ◆ UNIT: mm

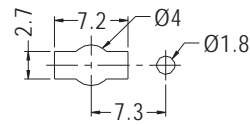
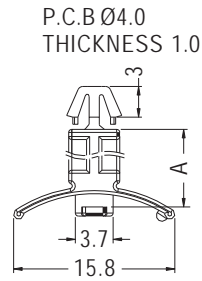

MOUNTING HOLE THICKNESS 0.6-1.0

PARTNO	A	PACKAGE
LCBA-5.6	5.6	1000
LCBA-7.6	7.6	

1

SPACER SUPPORT

- ◆ MATERIAL: NYLON 66 (UL)
- ◆ FLAME CLASS: 94V-2/94V-0
- ◆ COLOR: NATURAL/BLACK
- ◆ UNIT: mm

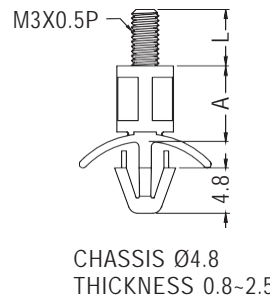
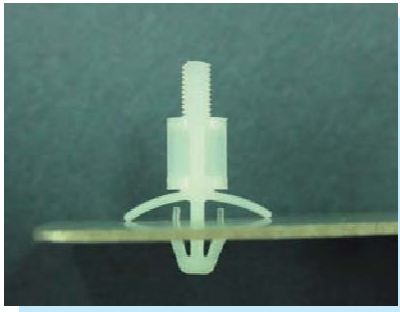

CHASSIS Ø4.8 THICKNESS 0.8-2.5

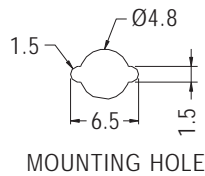

MOUNTING HOLE

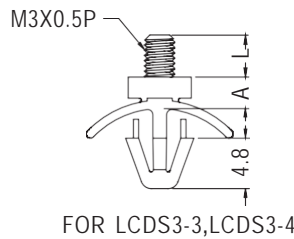

FOR LCDS3-3, LCDS3-4

PARTNO	A	L	PACKAGE
LCDS3-3	3.0	4.0	1000
LCDS3-4	4.0	4.0	
LCDS3-5	5.0	4.0	
LCDS3-6	6.0	6.0	
LCDS3-7	7.0	6.0	
LCDS3-8	8.0	6.0	
LCDS3-9	9.0	6.0	
LCDS3-10	10.0	6.0	
LCDS3-11	11.0	6.0	
LCDS3-12	12.0	6.0	
LCDS3-13	13.0	6.0	
LCDS3-14	14.0	6.0	
LCDS3-15	15.0	6.0	

SPACER SUPPORT

- ◆ MATERIAL: NYLON 66 (UL)
- ◆ FLAME CLASS: 94V-2/94V-0
- ◆ COLOR: NATURAL/BLACK
- ◆ UNIT: mm

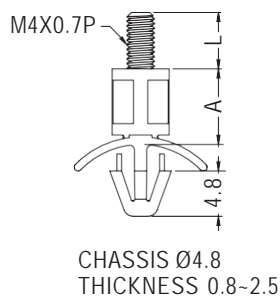

CHASSIS Ø4.8 THICKNESS 0.8-2.5

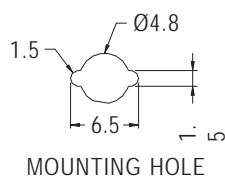

MOUNTING HOLE

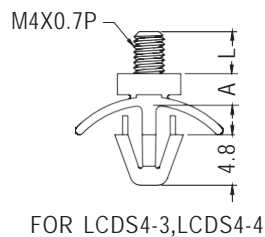

FOR LCDS4-3, LCDS4-4

PARTNO	A	L	PACKAGE
LCDS4-3	3.0	4.0	1000
LCDS4-4	4.0	4.0	
LCDS4-5	5.0	4.0	
LCDS4-6	6.0	6.0	
LCDS4-7	7.0	6.0	
LCDS4-8	8.0	6.0	
LCDS4-9	9.0	6.0	
LCDS4-10	10.0	6.0	
LCDS4-11	11.0	6.0	
LCDS4-12	12.0	6.0	
LCDS4-13	13.0	6.0	
LCDS4-14	14.0	6.0	
LCDS4-15	15.0	6.0	



SPACER SUPPORT

NEW

- ◆ MATERIAL: NYLON 66 (UL)
- ◆ FLAME CLASS: 94V-2/94V-0
- ◆ COLOR: NATURAL/BLACK/WHITE
- ◆ UNIT: mm

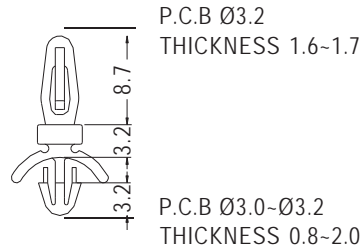

PART NO	PACKAGE
LCSE-3.2	1000

1

SPACER SUPPORT

- ◆ MATERIAL: NYLON 66 (UL)
- ◆ FLAME CLASS: 94V-2/94V-0
- ◆ COLOR: NATURAL/BLACK
- ◆ UNIT: mm

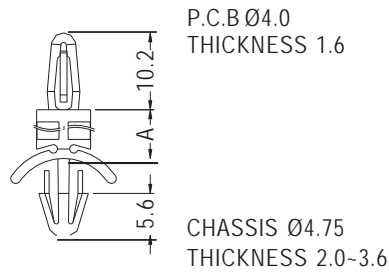

PART NO	A	PACKAGE
LCSA-6.4	6.4	1000
LCSA-9.5	9.5	

SPACER SUPPORT

- ◆ MATERIAL: NYLON 66 (UL)
- ◆ FLAME CLASS: 94V-2/94V-0
- ◆ COLOR: NATURAL/BLACK
- ◆ UNIT: mm

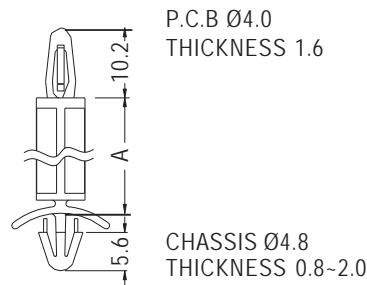
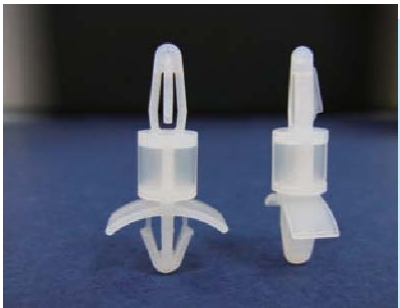

PART NO	A	PACKAGE
HLCS-4.8	4.8	1000
HLCS-9.5	9.5	
HLCS-12.7	12.7	
★ HLCS-25.4	25.4	500
★ HLCS-40	40.0	

SPACER SUPPORT

- ◆ MATERIAL: NYLON 66 (UL)
- ◆ FLAME CLASS: 94V-2/94V-0
- ◆ COLOR: NATURAL/BLACK
- ◆ UNIT: mm

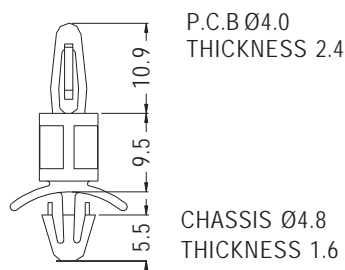

PART NO	PACKAGE
LCSLR-9.5	1000



SPACER SUPPORT



- ◆ MATERIAL: NYLON 66 (UL)
- ◆ FLAME CLASS: 94V-2/94V-0
- ◆ COLOR: NATURAL/BLACK
- ◆ UNIT: mm

P.C.B Ø4.0
THICKNESS 1.6

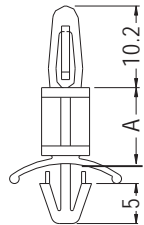

CHASSIS Ø4.8
THICKNESS 0.8-2.0

PART NO	A	PACKAGE
LCS-3	3.5	1000
LCS-5	4.8	
LCS-6	6.0	
LCS-6A	6.4	
LCS-8	7.9	
LCS-9	9.5	
LCS-11	11.1	
LCS-12	12.7	
LCS-16	15.9	

PART NO	A	PACKAGE
LCS-19	19.1	1000
LCS-22	22.2	
LCS-24	24.0	
LCS-25	25.4	
LCS-27.5	27.5	
LCS-28	28.6	
LCS-31.1	31.1	
LCS-31.7	31.7	
LCS-35	34.9	

SPACER SUPPORT

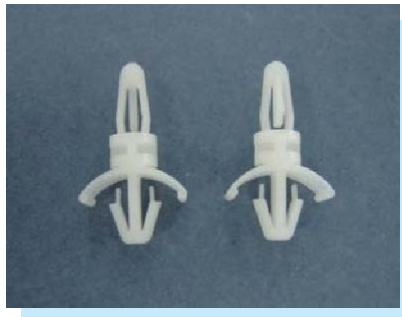

- ◆ MATERIAL: NYLON 66 (UL)
- ◆ FLAME CLASS: 94V-2/94V-0
- ◆ COLOR: NATURAL/BLACK
- ◆ UNIT: mm

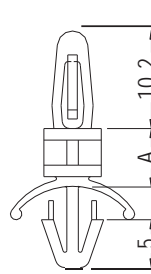

P.C.B Ø4.0
THICKNESS: E

CHASSIS Ø4.8
THICKNESS 2.0-3.2

PART NO	A	E	PACKAGE
LCSD-4.8	4.8	1.6	1000
LCSD-9.5	9.5	1.6	
LCSD-12.7	12.7	1.6	

PART NO	A	E	PACKAGE
LCSL-4.8	4.8	2.0-3.2	1000

SPACER SUPPORT



- ◆ MATERIAL: NYLON 66 (UL)
- ◆ FLAME CLASS: 94V-2/94V-0
- ◆ COLOR: NATURAL/BLACK
- ◆ UNIT: mm

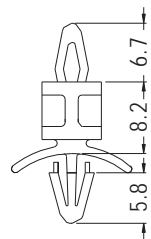

CHASSIS Ø3.5
THICKNESS 1.6

CHASSIS Ø4.0
THICKNESS 0.8-1.6

PART NO	PACKAGE
LCPA-8.2	1000

SPACER SUPPORT



- ◆ MATERIAL: NYLON 66 (UL)
- ◆ FLAME CLASS: 94V-2/94V-0
- ◆ COLOR: NATURAL/BLACK
- ◆ UNIT: mm

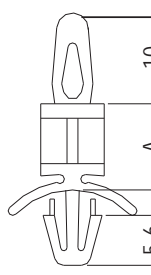

P.C.B Ø4.0
THICKNESS 1.2-1.7

P.C.B Ø4.8
THICKNESS 0.8-2.5

PART NO	A	PACKAGE
LCP-7.9	7.9	1000
LCP-9	9.5	
LCP-12.7	12.7	
LCP-22	22.2	



SPACER SUPPORT

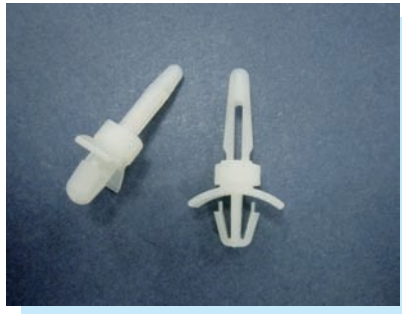

- ◆ MATERIAL: NYLON 66 (UL)
- ◆ FLAME CLASS: 94V-2/94V-0
- ◆ COLOR: NATURAL/BLACK
- ◆ UNIT: mm

P.C.B Ø4.0
THICKNESS 1.2-1.7

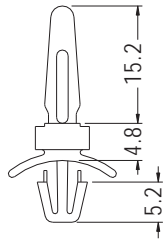

CHASSIS Ø4.8
THICKNESS 0.8-2.0

PART NO	PACKAGE
LCY-4.8	1000

SPACER SUPPORT

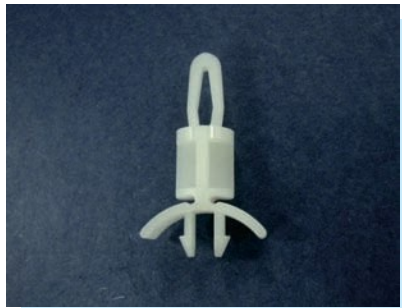

- ◆ MATERIAL: NYLON 66 (UL)
- ◆ FLAME CLASS: 94V-2/94V-0
- ◆ COLOR: NATURAL/BLACK
- ◆ UNIT: mm

P.C.B Ø4.0
THICKNESS 1.2-1.7

P.C.B Ø3.8
THICKNESS 1.6

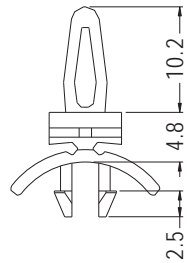
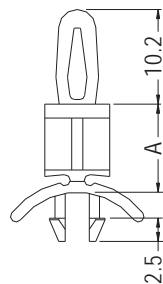

P.C.B Ø4.8
THICKNESS 0.8-2.5

CHASSIS Ø4.8
THICKNESS 0.8-2.5
FOR UCBS-5A

PART NO	A	PACKAGE
UCBS-5	4.8	1000
UCBS-5A	4.8	
UCBS-6	6.4	
UCBS-9	9.5	
UCBS-12	12.7	
UCBS-15	15.9	
UCBS-19	19.1	
UCBS-22	22.2	

SPACER SUPPORT



- ◆ MATERIAL: NYLON 66 (UL)
- ◆ FLAME CLASS: 94V-2/94V-0
- ◆ COLOR: NATURAL/BLACK
- ◆ UNIT: mm

P.C.B Ø4.0
THICKNESS 1.2-1.7

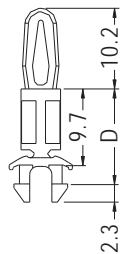

P.C.B Ø5.4
THICKNESS: F

PART NO	D	F	PACKAGE
UCBSL-9	11.7	1.6	1000
UCBSL-10	12.0	2.2	



SPACER SUPPORT

- ◆ MATERIAL:NYLON 66 (UL)
- ◆ FLAME CLASS:94V-2/94V-0
- ◆ COLOR:NATURAL/BLACK
- ◆ UNIT:mm

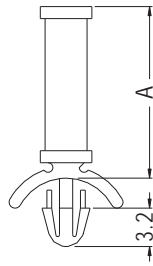

CHASSIS Ø3.0
THICKNESS 0.8-2.0

PART NO	A	PACKAGE
LBS-3	3.2	1000
LBS-5	4.8	
LBS-6	6.4	
LBS-8	7.9	
LBS-9	9.5	
LBS-11	11.1	
LBS-12	12.7	
LBS-14	14.3	
LBS-15	15.9	
LBS-17	17.0	
LBS-19	19.0	
★LBS-26	26.0	

1

SPACER SUPPORT

- ◆ MATERIAL:NYLON 66 (UL)
- ◆ FLAME CLASS:94V-2/94V-0
- ◆ COLOR:NATURAL/BLACK
- ◆ UNIT:mm

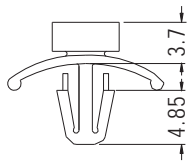

CHASSIS Ø4.0
THICKNESS 1.0-2.0

PART NO	PACKAGE
LASB-3.7	1000

SPACER SUPPORT

- ◆ MATERIAL:NYLON 66 (UL)
- ◆ FLAME CLASS:94V-2/94V-0
- ◆ COLOR:NATURAL/BLACK
- ◆ UNIT:mm

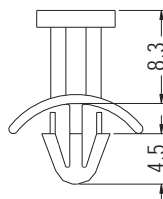

CHASSIS Ø4.5
THICKNESS 0.8-2.0

PART NO	PACKAGE
LASD-8.3	1000



SPACER SUPPORT

- ◆ MATERIAL: NYLON 66 (UL)
- ◆ FLAME CLASS: 94V-2/94V-0
- ◆ COLOR: NATURAL/BLACK
- ◆ UNIT: mm

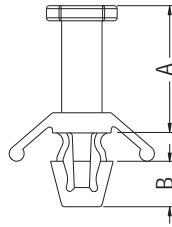

P.C.B Ø4.8
THICKNESS: F

PART NO	A	B	F	PACKAGE
LASY-4.6	4.6	4.6	0.8~2.5	1000
LASY-9.3	9.3	4.5	0.5~2.3	
LASY-12.6	12.6	4.5		

SPACER SUPPORT

- ◆ MATERIAL: NYLON 66 (UL)
- ◆ FLAME CLASS: 94V-2/94V-0
- ◆ COLOR: NATURAL/BLACK
- ◆ UNIT: mm

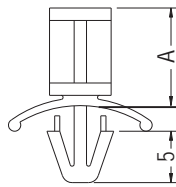
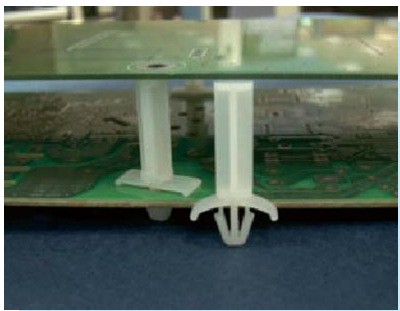

CHASSIS Ø4.8
THICKNESS 0.8-2.0

PARTNO	A	PACKAGE
LAS-3	3.5	1000
LAS-5	4.8	
LAS-6	6.0	
LAS-6A	6.4	
LAS-8	7.9	
LAS-9	9.5	
LAS-11	11.1	
LAS-12	12.7	
LAS-16	15.9	

PARTNO	A	PACKAGE
LAS-19	19.1	1000
LAS-22	22.2	
LAS-24	24.0	
LAS-25	25.4	
LAS-27.5	27.5	
LAS-28	28.6	500
LAS-31.1	31.1	
LAS-31.7	31.7	
LAS-35	34.9	

SPACERSUPPORT

- ◆ MATERIAL: NYLON 66 (UL)
- ◆ FLAME CLASS: 94V-2/94V-0
- ◆ COLOR: NATURAL/BLACK
- ◆ UNIT: mm

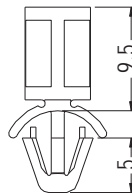
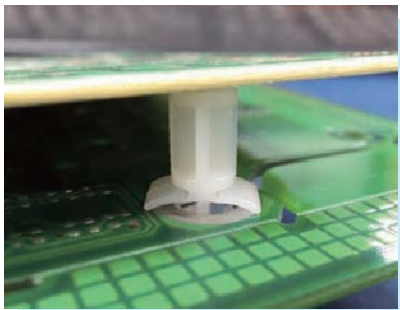

CHASSIS Ø4.8-Ø5.0
THICKNESS 0.8-2.0

PARTNO	PACKAGE
LASA-9.5	1000

SPACERSUPPORT

- ◆ MATERIAL: NYLON 66 (UL)
- ◆ FLAME CLASS: 94V-2/94V-0
- ◆ COLOR: NATURAL/BLACK
- ◆ UNIT: mm

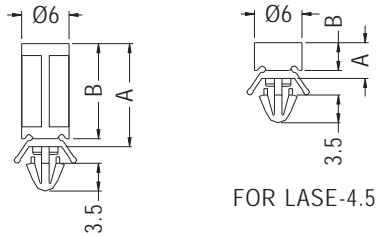

MOUNTING HOLE Ø3.5
 THICKNESS 1.2-1.6

PART NO	A	B	PACKAGE
LASE-4.5	4.5	3.5	1000
LASE-7	7.0	6.0	
LASE-12	12.0	11.0	

SPACERSUPPORT

- ◆ MATERIAL: NYLON 66 (UL)
- ◆ FLAME CLASS: 94V-2/94V-0
- ◆ COLOR: NATURAL/BLACK
- ◆ UNIT: mm

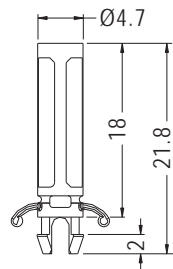

MOUNTING HOLE Ø4.0
 THICKNESS 1.2-1.6

PART NO	PACKAGE
LASF-18	1000

SPACERSUPPORT

- ◆ MATERIAL: NYLON 66 (UL)
- ◆ FLAME CLASS: 94V-2/94V-0
- ◆ COLOR: NATURAL/WHITE/BLACK
- ◆ UNIT: mm

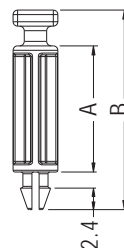

MOUNTING HOLE Ø3.0
 THICKNESS 1.6

PART NO	A	B	PACKAGE
MSA-14.1	14.1	22.3	1000
MSA-24.3	24.3	32.5	

SUPPORT



- ◆ MATERIAL: NYLON 66 (UL)
- ◆ FLAME CLASS: 94V-2/94V-0
- ◆ COLOR: NATURAL/BLACK
- ◆ UNIT: mm

P.C.B Ø1.5
THICKNESS 1.0

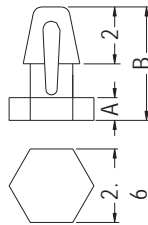

PART NO	A	B	PACKAGE
MASD-0.8	0.8	4.0	2000
MASD-2	2.0	5.2	

SUPPORT



- ◆ MATERIAL: NYLON 66 (UL)
- ◆ FLAME CLASS: 94V-2/94V-0
- ◆ COLOR: NATURAL/BLACK
- ◆ UNIT: mm

P.C.B Ø1.5
THICKNESS 1.6

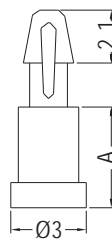

PART NO	A	PACKAGE
MASS-2	2.0	2000
MASS-2.5	2.5	
MASS-3	3.0	
MASS-3.5	3.5	
MASS-4	4.0	
MASS-5	5.0	
MASS-6	6.0	
MASS-6.5	6.5	

SUPPORT



- ◆ MATERIAL: NYLON 66 (UL)
- ◆ FLAME CLASS: 94V-2/94V-0
- ◆ COLOR: NATURAL/BLACK
- ◆ UNIT: mm

P.C.B Ø2.0
THICKNESS: E

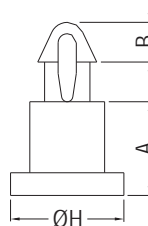

P.C.B Ø2.0
THICKNESS: E

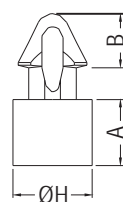

FOR MA-2.5S, MA-3S-1

PART NO	A	B	E	H	PACKAGE
MA-1.8	1.8	1.9	1.6	4.2	2000
MA-2	2.0	1.9	1.6	4.2	
MA-2L	2.0	2.05	2.0	4.8	
MA-2.5	2.5	1.9	1.6	4.1	
MA-2.5L	2.5	2.0	1.6	4.8	
MA-2.5S	2.5	2.05	1.0	3.0	
MA-3	3.0	1.9	1.6	4.8	
MA-3S	3.0	1.8	1.6	4.2	
MA-3S-1	3.0	2.05	1.0	3.0	
MA-3.2	3.2	1.9	1.6	4.8	
MA-3.5	3.5	1.9	1.6	4.2	
MA-4	4.0	1.9	1.6	4.8	
MA-4.5	4.5	1.9	1.6	4.2	
MA-4.7	4.7	1.9	1.6	4.8	
MA-5	5.0	1.9	1.6	4.8	
MA-5.6	5.6	2.0	1.6	4.2	
MA-6	6.0	1.9	1.6	5.0	
MA-6.5	6.5	1.9	1.6	5.0	
MA-6.75	6.75	1.9	1.6	5.0	
MA-8	8.0	1.9	1.6	5.0	
MA-9	9.0	1.9	1.6	5.0	



SPACER SUPPORT



- ◆ MATERIAL: NYLON 66 (UL)
- ◆ FLAME CLASS: 94V-2/94V-0
- ◆ COLOR: NATURAL/BLACK
- ◆ UNIT: mm

P.C.B Ø2.0
THICKNESS 1.6

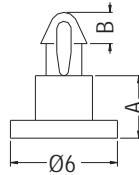

PART NO	A	B	PACKAGE
MA-2.7DL	2.7	1.9	2000
MA-3.5DL	3.5	1.75	
MA-3.85DL	3.85	1.9	
MA-4.5DL	4.5	1.9	
MA-5DL	5.0	1.9	
MA-6.5DL	6.5	1.9	

SPACER SUPPORT



- ◆ MATERIAL: NYLON 66 (UL)
- ◆ FLAME CLASS: 94V-2/94V-0
- ◆ COLOR: NATURAL/BLACK
- ◆ UNIT: mm

P.C.B Ø2.5
THICKNESS 1.0

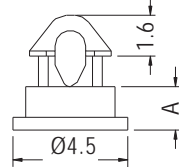

PART NO	A	PACKAGE
MAMS-1.7	1.7	2000
MAMS-5	5.0	

SPACER SUPPORT



- ◆ MATERIAL: NYLON 66 (UL)
- ◆ FLAME CLASS: 94V-2/94V-0
- ◆ COLOR: NATURAL/BLACK
- ◆ UNIT: mm

P.C.B Ø2.5
THICKNESS 1.6-1.8

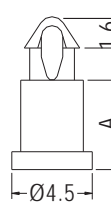

P.C.B Ø2.5
THICKNESS 1.6-1.8

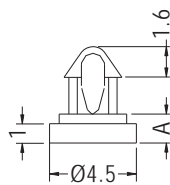

FOR MAM-1.5L

P.C.B Ø2.5
THICKNESS 1.6

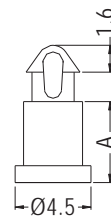

FOR MAM-4.8, MAM-6.4

PART NO	A	PACKAGE
MAM-1.5	1.5	2000
MAM-1.5L	1.5	
MAM-2.5	2.5	
MAM-2.7	2.7	
MAM-3	3.0	
MAM-3.2	3.2	
MAM-3.5	3.5	
MAM-4	4.0	
MAM-4.5	4.5	
MAM-4.8	4.8	
MAM-5	5.0	
MAM-5.7	5.7	
MAM-6	6.0	
MAM-6.4	6.4	

SPACER SUPPORT



- ◆ MATERIAL: NYLON 66 (UL)
- ◆ FLAME CLASS: 94V-2/94V-0
- ◆ COLOR: NATURAL/BLACK
- ◆ UNIT: mm

NEW

P.C.B Ø2.7
THICKNESS 1.6

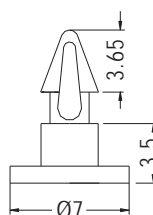

PART NO	PACKAGE
MAMA-3.5	1000

SPACER SUPPORT



- ◆ MATERIAL: NYLON 66 (UL)
- ◆ FLAME CLASS: 94V-2/94V-0
- ◆ COLOR: NATURAL/WHITE/BLACK
- ◆ UNIT: mm

P.C.B Ø2.0
THICKNESS 1.6

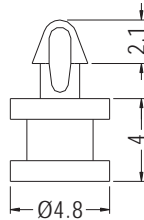

PART NO	PACKAGE
MAB-4	1000

SPACER SUPPORT



- ◆ MATERIAL: NYLON 66 (UL)
- ◆ FLAME CLASS: 94V-2/94V-0
- ◆ COLOR: NATURAL/BLACK
- ◆ UNIT: mm

P.C.B Ø2.0
THICKNESS 1.6

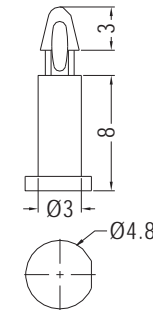

PART NO	PACKAGE
MAL-8	1000

P.C.B Ø3.0
THICKNESS 1.6

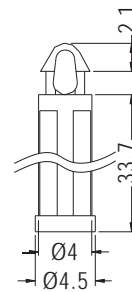

PART NO	PACKAGE
MAL-34	500

SPACER SUPPORT



- ◆ MATERIAL: NYLON 66 (UL)
- ◆ FLAME CLASS: 94V-2/94V-0
- ◆ COLOR: NATURAL/BLACK
- ◆ UNIT: mm

P.C.B Ø2.5
THICKNESS 1.0

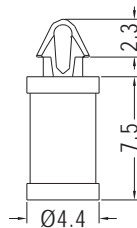

PART NO	PACKAGE
MAMS-7.5	1000

SPACER SUPPORT



- ◆ MATERIAL: NYLON 66 (UL)
- ◆ FLAME CLASS: 94V-2/94V-0
- ◆ COLOR: NATURAL/BLACK
- ◆ UNIT: mm

P.C.B Ø2.5
THICKNESS 1.6

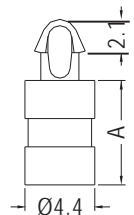

PART NO	A	PACKAGE
MAM-6.8	6.8	2000
MAM-7	7.0	
MAM-8	8.0	
★ MAM-8.4	8.4	
MAM-9	9.0	
MAM-11	11.1	
MAM-12.7	12.7	
MAM-15.9	15.9	



SPACER SUPPORT



- ◆ MATERIAL: NYLON 66 (UL)
- ◆ FLAME CLASS: 94V-2/94V-0
- ◆ COLOR: NATURAL/BLACK
- ◆ UNIT: mm

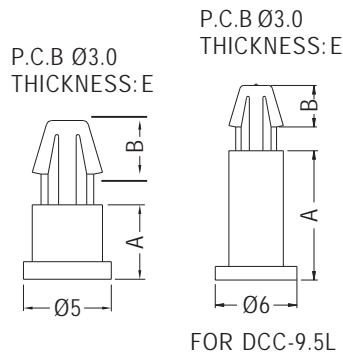

PARTNO	A	B	E	PACKAGE
DCC-2	2.0	3.05	1.2~1.6	2000
DCC-2.5	2.5	3.05	1.2~1.6	
DCC-2.7	2.7	3.05	1.2~1.6	
DCC-3	3.0	3.05	1.2~1.6	
DCC-3.2	3.2	3.05	1.2~1.6	1000
DCC-3.5	3.5	3.05	1.2~1.6	
DCC-4	4.0	3.05	1.2~1.6	
DCC-4.5	4.5	3.05	1.2~1.6	
DCC-5	5.0	3.05	1.2~1.6	
DCC-5S	5.0	2.6	0.8~1.2	
DCC-5.5	5.5	3.05	1.2~1.6	
DCC-6	6.0	3.05	1.2~1.6	
DCC-6.2	6.2	3.05	1.2~1.6	
DCC-6.5	6.5	3.05	1.2~1.6	
★ DCC-9.5L	9.5	3.05	1.2~1.6	

1

SPACER SUPPORT



- ◆ MATERIAL: NYLON 66 (UL)
- ◆ FLAME CLASS: 94V-2/94V-0
- ◆ COLOR: NATURAL/BLACK
- ◆ UNIT: mm

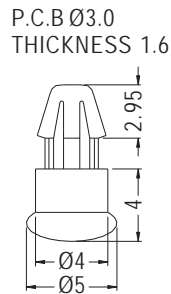

PARTNO	PACKAGE
DCE-4	1000

SPACER SUPPORT



- ◆ MATERIAL: NYLON 66 (UL)
- ◆ FLAME CLASS: 94V-2/94V-0
- ◆ COLOR: NATURAL/BLACK
- ◆ UNIT: mm

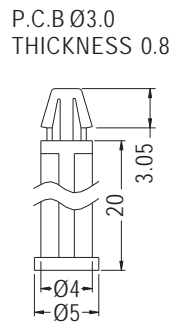

PARTNO	PACKAGE
DCC-20S	1000

SPACER SUPPORT



- ◆ MATERIAL: NYLON 66 (UL)
- ◆ FLAME CLASS: 94V-2/94V-0
- ◆ COLOR: NATURAL/BLACK
- ◆ UNIT: mm

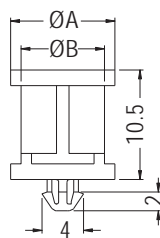

HOLE Ø3.0
THICKNESS 1.0

PARTNO	A	B	PACKAGE
TCBA-10.5	10.0	8.0	1000
TCBA-10.5S	7.5	6.0	



SPACER SUPPORT



- ◆ MATERIAL: NYLON 66 (UL)
- ◆ FLAME CLASS: 94V-2/94V-0
- ◆ COLOR: NATURAL/BLACK
- ◆ UNIT: mm

P.C.B Ø3.5
 THICKNESS 0.8-1.6

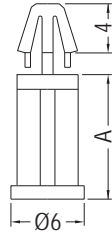

PARTNO	A	PACKAGE
MCM-8	8.0	1000
MCM-1 4.5	14.5	

SPACER SUPPORT



- ◆ MATERIAL: NYLON 66 (UL)
- ◆ FLAME CLASS: 94V-2/94V-0
- ◆ COLOR: NATURAL/WHITE/BLACK
- ◆ UNIT: mm

P.C.B Ø4.0
 THICKNESS 1.2-1.6

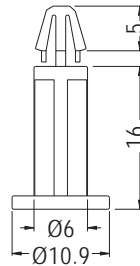

PARTNO	PACKAGE
MCO-16	1000

SPACER SUPPORT



- ◆ MATERIAL: NYLON 66 (UL)
- ◆ FLAME CLASS: 94V-2/94V-0
- ◆ COLOR: NATURAL/BLACK
- ◆ UNIT: mm

P.C.B Ø2.0
 THICKNESS: E

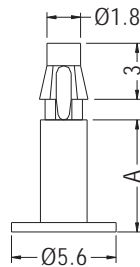

PARTNO	A	E	PACKAGE
MAST-6	6.0	1.0	1000
MAST-18	18.8	1.6	

SPACER SUPPORT



- ◆ MATERIAL: NYLON 66 (UL)
- ◆ FLAME CLASS: 94V-2/94V-0
- ◆ COLOR: NATURAL/BLACK
- ◆ UNIT: mm

P.C.B Ø2.0
 THICKNESS 2.4

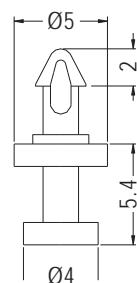

PARTNO	PACKAGE
MASL-5.4	1000

SPACER SUPPORT



- ◆ MATERIAL: NYLON 66 (UL)
- ◆ FLAME CLASS: 94V-2/94V-0
- ◆ COLOR: NATURAL/BLACK
- ◆ UNIT: mm

P.C.B Ø2.0
THICKNESS 1.2-1.8

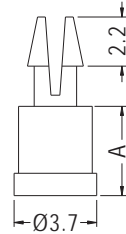

PART NO	A	PACKAGE
MS-4	4.0	2000
MS-5	5.0	
★ MS-10	10.0	

SPACER SUPPORT



- ◆ MATERIAL: NYLON 66 (UL)
- ◆ FLAME CLASS: 94V-2/94V-0
- ◆ COLOR: NATURAL/BLACK
- ◆ UNIT: mm

CHASSIS Ø2.2
THICKNESS 1.6

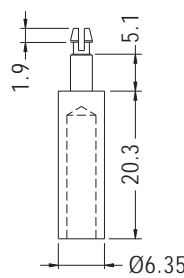

PART NO	PACKAGE
PCLS-25	1000



SPACER SUPPORT



- ◆ MATERIAL: NYLON 66 (UL)
- ◆ FLAME CLASS: 94V-2/94V-0
- ◆ COLOR: NATURAL/BLACK
- ◆ UNIT: mm

P.C.B Ø2.3
THICKNESS 1.6

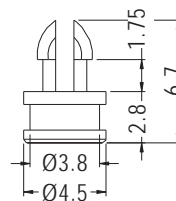

PART NO	PACKAGE
MSB-2.8	1000

SPACER SUPPORT



- ◆ MATERIAL: PBT (UL)
- ◆ FLAME CLASS: 94V-0
- ◆ COLOR: NATURAL
- ◆ UNIT: mm

P.C.B Ø2.5
THICKNESS 1.6

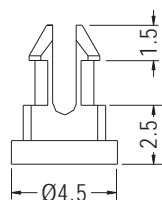

PART NO	PACKAGE
MSM-2.5	1000



SPACER SUPPORT

NEW



- ◆ MATERIAL: NYLON 66 (UL)
- ◆ FLAME CLASS: 94V-2/94V-0
- ◆ COLOR: NATURAL/BLACK
- ◆ UNIT: mm

P.C.B Ø3.9
THICKNESS 1.6

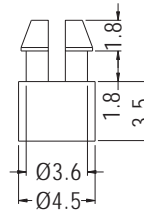

PART NO	PACKAGE
MSMA-3.5	2000

1

SPACER SUPPORT



- ◆ MATERIAL: NYLON 66 (UL)
- ◆ FLAME CLASS: 94V-2/94V-0
- ◆ COLOR: NATURAL/BLACK
- ◆ UNIT: mm

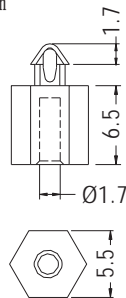

P.C.B Ø2.5
THICKNESS 1.6

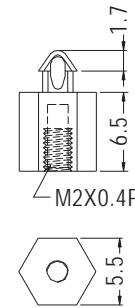

P.C.B Ø2.5
THICKNESS 1.6

- ◆ MAE-XT M2X0.4P

PART NO	PACKAGE
MAE2.5-6.5	2000

PART NO	PACKAGE
MAE2.5-6.5T	2000

SPACER SUPPORT

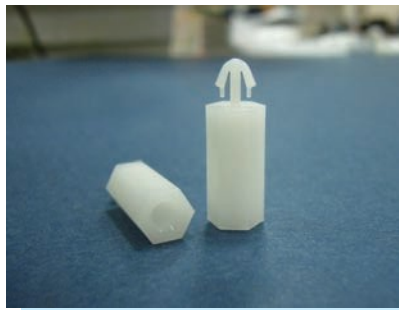

- ◆ MATERIAL: NYLON 66 (UL)
- ◆ FLAME CLASS: 94V-2/94V-0
- ◆ COLOR: NATURAL/BLACK
- ◆ UNIT: mm

P.C.B Ø3.0
THICKNESS 1.6

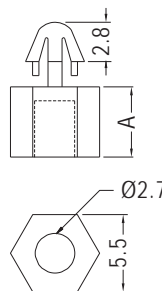

PART NO	A	PACKAGE
MAE-5	5.0	2000
MAE-6	6.0	
MAE-7	7.0	
MAE-8	8.0	
MAE-9	9.0	
MAE-10	10.0	1000
MAE-11	11.0	
MAE-12	12.0	
MAE-13	13.0	

PART NO	A	PACKAGE
MAE-14	14.0	1000
MAE-15	15.0	
MAE-16	16.0	
MAE-17	17.0	
MAE-18	18.0	
MAE-19	19.0	
MAE-20	20.0	
MAE-22	22.0	
MAE-23.5	23.5	
MAE-26	26.0	

P.C.B Ø3.0
THICKNESS 1.6

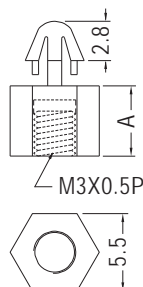

- ◆ MAE-XT M3X0.5P

PART NO	A	PACKAGE
MAE-5T	5.0	2000
MAE-6T	6.0	
MAE-7T	7.0	
MAE-8T	8.0	
MAE-9T	9.0	
MAE-10T	10.0	1000
MAE-11T	11.0	
MAE-12T	12.0	
MAE-13T	13.0	
MAE-14T	14.0	

PART NO	A	PACKAGE
MAE-15T	15.0	1000
MAE-16T	16.0	
MAE-17T	17.0	
MAE-18T	18.0	
MAE-19T	19.0	
MAE-20T	20.0	
MAE-22T	22.0	
MAE-23.5T	23.5	
MAE-26T	26.0	
MAE-27T	27.0	



SPACER SUPPORT



MATERIAL: NYLON 66 (UL)
FLAME CLASS: 94V-2/94V-0
COLOR: NATURAL/BLACK
UNIT:

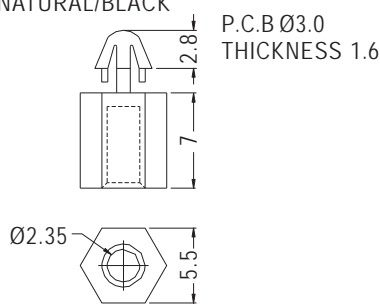

PART NO	PACKAGE
MAE-7-440	2000

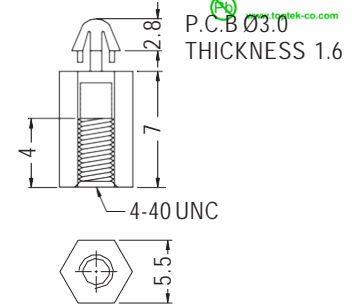

PART NO	PACKAGE
MAE-7-440T	2000

1

SPACER SUPPORT



MATERIAL: NYLON 66 (UL)
FLAME CLASS: 94V-2/94V-0
COLOR: NATURAL/BLACK
UNIT:

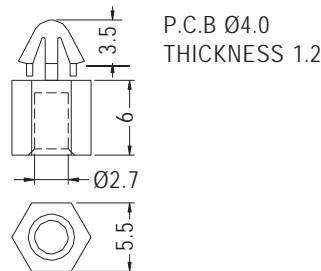

PART NO	PACKAGE
MAE4D-6	1000

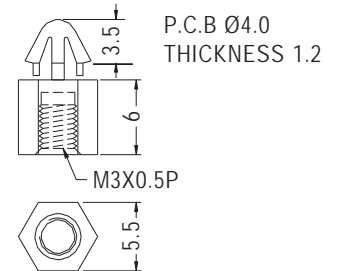

MAE4D-6T M3X0.5P

PART NO	PACKAGE
MAE4D-6T	1000

SPACER SUPPORT



MATERIAL: NYLON 66 (UL)
FLAME CLASS: 94V-2/94V-0
COLOR: NATURAL/BLACK
UNIT:

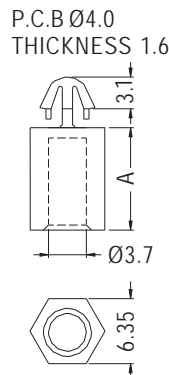

PART NO	A	PACKAGE
MAE4-5	5.0	2000
MAE4-6	6.0	
MAE4-7	7.0	
MAE4-8	8.0	
MAE4-9	9.0	
MAE4-10	10.0	
MAE4-11	11.0	
MAE4-12.7	12.7	
MAE4-14	14.0	
MAE4-15	15.0	
MAE4-15.9	15.9	
MAE4-20	20.0	

P.C.B Ø4.0 THICKNESS 1.6

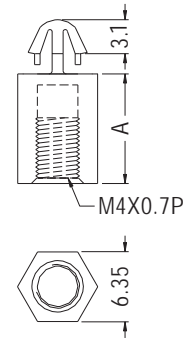

MAE4-XT M4X0.7P

PART NO	A	PACKAGE
MAE4-5T	5.0	2000
MAE4-6T	6.0	
MAE4-7T	7.0	
MAE4-8T	8.0	
MAE4-9T	9.0	
MAE4-10T	10.0	
MAE4-11T	11.0	
MAE4-12.7T	12.7	
MAE4-14T	14.0	
MAE4-15T	15.0	
MAE4-15.9T	15.9	
MAE4-20T	20.0	



SPACER SUPPORT



- ◆ MATERIAL: NYLON 66 (UL)
- ◆ FLAME CLASS: 94V-2/94V-0
- ◆ COLOR: NATURAL/BLACK
- ◆ UNIT: mm

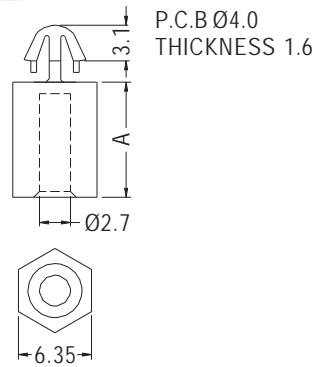

P.C.B Ø4.0 THICKNESS 1.6

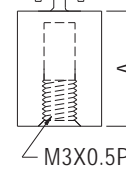

◆ MAE43-XT M3X0.5P

P.C.B Ø4.0 THICKNESS 1.85

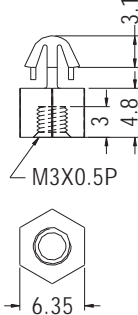

PART NO	PACKAGE
★ MAE43-4.8LT	1000

PART NO	A	PACKAGE
MAE43-5	5.0	2000
MAE43-6	6.0	
MAE43-7	7.0	
MAE43-8	8.0	
MAE43-9	9.0	
MAE43-10	10.0	
MAE43-11	11.0	
MAE43-12.7	12.7	
MAE43-14	14.0	
MAE43-15	15.0	
MAE43-15.9	15.9	
MAE43-20	20.0	

PART NO	A	PACKAGE
MAE43-5T	5.0	2000
MAE43-6T	6.0	
MAE43-7T	7.0	
MAE43-8T	8.0	
MAE43-9T	9.0	
MAE43-10T	10.0	
MAE43-11T	11.0	
MAE43-12.7T	12.7	
MAE43-14T	14.0	
MAE43-15T	15.0	
MAE43-15.9T	15.9	
MAE43-20T	20.0	

SPACER SUPPORT



- ◆ MATERIAL: NYLON 66 (UL)
- ◆ FLAME CLASS: 94V-2/94V-0
- ◆ COLOR: NATURAL/BLACK
- ◆ UNIT: mm

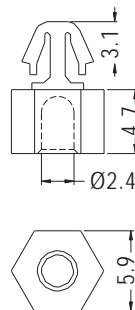

P.C.B Ø4.0 THICKNESS 1.6

PART NO	PACKAGE
MCI-4.7	1000

SPACER SUPPORT



- ◆ MATERIAL: NYLON 66 (UL)
- ◆ FLAME CLASS: 94V-2/94V-0
- ◆ COLOR: NATURAL/BLACK
- ◆ UNIT: mm

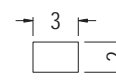
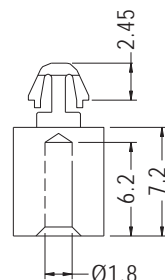

MOUNTING HOLE THICKNESS 1.6

PART NO	PACKAGE
MCSH-7.2	1000



SPACER SUPPORT

- ◆ MATERIAL: NYLON 66 (UL)
- ◆ FLAME CLASS: 94V-2/94V-0
- ◆ COLOR: NATURAL/BLACK
- ◆ UNIT: mm

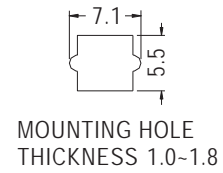
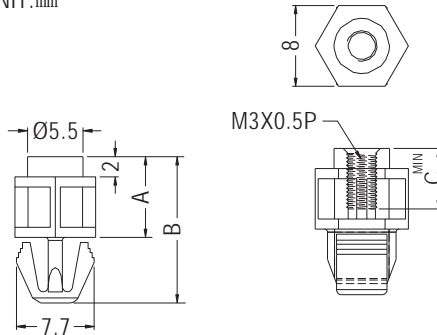

MOUNTING HOLE THICKNESS 1.0-1.8

PARTNO	A	B	C	PACKAGE
KVLM3-5	5.0	11.5	3.0	1000
KVLM3-6	6.0	12.5	4.0	
KVLM3-6.35	6.35	12.85	4.35	
KVLM3-8	8.0	14.5	6.0	
KVLM3-9.5	9.5	16.0	8.0	
KVLM3-10	10.0	16.5	8.0	

PARTNO	A	B	C	PACKAGE
KVLM3-12	12.0	18.5	8.0	1000
KVLM3-12.7	12.7	19.2	8.0	
KVLM3-15.9	15.9	22.4	8.0	
KVLM3-18	18.0	24.5	8.0	
KVLM3-20	20.0	26.5	8.0	
KVLM3-22	22.0	28.5	8.0	
KVLM3-25.4	25.4	31.9	8.0	

SPACER SUPPORT

- ◆ MATERIAL: NYLON 66 (UL)
- ◆ FLAME CLASS: 94V-2/94V-0
- ◆ COLOR: NATURAL/BLACK
- ◆ UNIT: mm

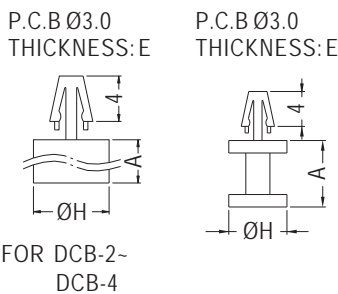

FOR DCB-2-DCB-4

PARTNO	A	E	H	PACKAGE
DCB-2	2.0	1.6	6.5	2000
DCB-2.5	2.5	1.6	6.5	
DCB-3	3.0	1.6	6.8	
DCB-3.5	3.5	1.6	6.8	
DCB-4	4.0	1.6	6.8	
DCB-5	5.0	1.6	6.0	
DCB-5.8	5.8	1.6	6.9	
DCB-6	6.0	1.6	6.8	
DCB-6.5	6.5	1.6	6.0	1000
DCB-7	7.0	1.6	6.0	
DCB-8	8.0	1.6	6.8	
DCB-8(2)	8.0	2.1	6.8	
DCB-10	10.0	1.6	6.8	
DCB-15	15.0	1.6	6.0	
DCB-15L	15.0	1.6	15.0	

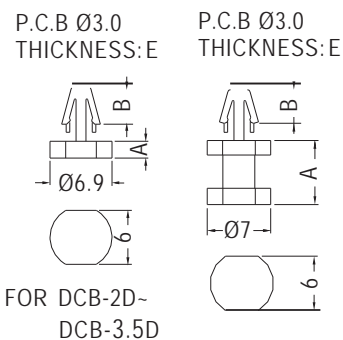

FOR DCB-2D-DCB-3.5D

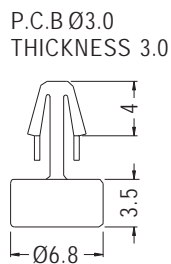

DCBA-3.5	1000
----------	------

PARTNO	A	B	E	PACKAGE
DCB-2D	2.0	3.5	1.2~1.7	2000
DCB-3D	3.0	3.7	1.2~1.6	
DCB-3.5D	3.5	4.0	1.2~1.6	
DCB-4D	4.0	3.6	1.2~1.7	1000
DCB-4.5D	4.5	3.6	1.2~1.7	
DCB-5D	5.0	3.6	1.2~1.7	
DCB-5.5D	5.5	4.0	1.2~1.6	
DCB-7D	7.0	4.0	1.2~1.6	
DCB-8D	8.0	3.85	1.2~1.7	
DCB-8.5D	8.5	4.0	1.2~1.7	
DCB-9D	9.0	4.0	1.2~1.6	
DCB-11D	11.0	3.7	1.2~1.6	
DCB-12D	12.0	4.0	1.2~1.6	
DCB-13D	13.0	4.0	1.2~1.6	



SPACER SUPPORT



- ◆ MATERIAL: NYLON 66 (UL)
- ◆ FLAME CLASS: 94V-2/94V-0
- ◆ COLOR: NATURAL/BLACK
- ◆ UNIT: mm

P.C.B Ø3.5
THICKNESS: E

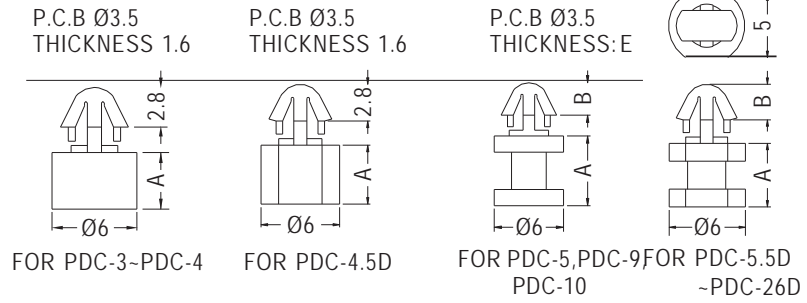

PART NO	A	PACKAGE
PDC-3	3.0	2000
PDC-3.5	3.5	
PDC-4	4.0	
PDC-4.5D	4.5	

PART NO	A	B	E	PACKAGE
PDC-5	5.0	2.8	1.6	2000
PDC-5.5D	5.5	2.8	1.6	
PDC-6D	6.0	2.8	1.6	
PDC-6.5D	6.5	2.8	1.6	
PDC-7D	7.0	2.8	1.6	
PDC-9	9.0	2.8	1.6	
PDC-10	10.0	2.6	1.8	
PDC-13D	13.0	2.8	1.2-1.7	
PDC-13.5D	13.5	2.8	1.6	
PDC-26D	26.0	2.8	1.6	

SPACER SUPPORT



- ◆ MATERIAL: NYLON 66 (UL)
- ◆ FLAME CLASS: 94V-2/94V-0
- ◆ COLOR: NATURAL/BLACK
- ◆ UNIT: mm

P.C.B Ø4.0
THICKNESS: E

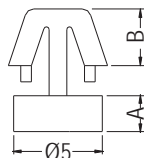

FOR MC-2-MC-2.5

P.C.B Ø4.0
THICKNESS: E

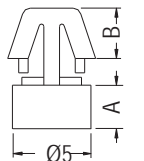

FOR MC-3-MC-5

PART NO	A	B	E	PACKAGE
MC-2	2.0	3.1	1.2-1.7	2000
MC-2-1.2	2.0	3.5	0.8-1.0	
MC-2.5	2.5	3.65	1.2-1.7	1000
MC-3	3.0	3.1	1.6	2000
MC-3.2	3.2	3.1	1.6	
MC-3.5	3.5	3.1	1.6	
MC-4	4.0	3.1	1.6	
MC-5	5.0	3.1	1.6	



P.C.B Ø4.0
THICKNESS 1.6

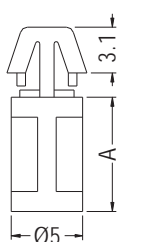

PART NO	A	PACKAGE
MC-6	6.3	2000
MC-7	7.0	
MC-7.5	7.5	
MC-8	8.0	
MC-8.5	8.5	
MC-9	9.0	
MC-10	10.0	
MC-11.5	11.5	1000
MC-12	12.7	
MC-16.4	16.4	



SPACER SUPPORT

- ◆ MATERIAL:PC (UL)
- ◆ FLAME CLASS:94V-2/94V-0
- ◆ COLOR:NATURAL/WHITE
- ◆ UNIT:mm

- ◆ MATERIAL:NYLON 66 (UL)



P.C.B Ø4.0

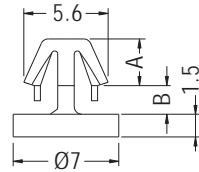

PART NO	A	B	PACKAGE
MCE-1.9	3.0	2.05	1000

P.C.B Ø4.0

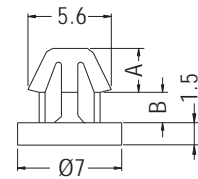

PART NO	A	B	PACKAGE
MCEA-1.9	2.8	2.2	1000

SPACER SUPPORT

- ◆ MATERIAL:NYLON 66 (UL)
- ◆ FLAME CLASS:94V-2/94V-0
- ◆ COLOR:NATURAL/BLACK
- ◆ UNIT:mm

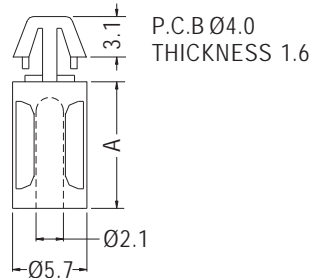

PART NO	A	PACKAGE
MCH-6	6.35	1000
MCH-10	9.7	
MCH-12	12.7	

SPACER SUPPORT

- ◆ MATERIAL:NYLON 66 (UL)
- ◆ FLAME CLASS:94V-2/94V-0
- ◆ COLOR:NATURAL/BLACK
- ◆ UNIT:mm

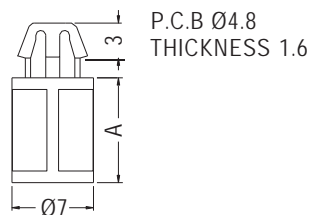

PART NO	A	PACKAGE
MCL-9	9.0	2000
MCL-16	16.0	

SPACER SUPPORT

- ◆ MATERIAL:NYLON 66 (UL)
- ◆ FLAME CLASS:94V-2/94V-0
- ◆ COLOR:NATURAL/BLACK
- ◆ UNIT:mm

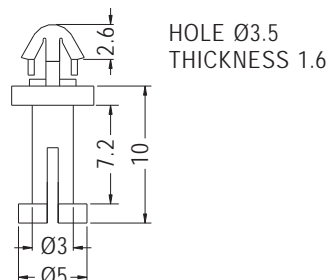

PART NO	PACKAGE
MCN-10	1000



SPACER SUPPORT

- ◆ MATERIAL: NYLON 66 (UL)
- ◆ FLAME CLASS: 94V-2/94V-0
- ◆ COLOR: NATURAL/BLACK
- ◆ UNIT: mm



P.C.B Ø4.0
THICKNESS 1.6

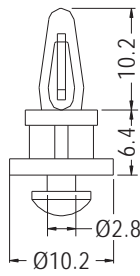

THICKNESS 1.6

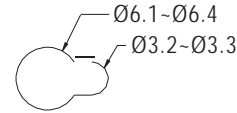

MOUNTING HOLE

PARTNO	PACKAGE
ACBR-6	1000

SPACER SUPPORT

- ◆ MATERIAL: NYLON 66 (UL)
- ◆ FLAME CLASS: 94V-2/94V-0
- ◆ COLOR: NATURAL/BLACK
- ◆ UNIT: mm

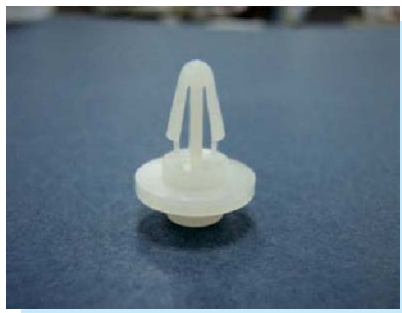

P.C.B Ø4.0
THICKNESS 1.6-2.0

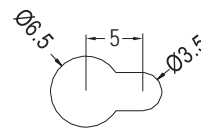
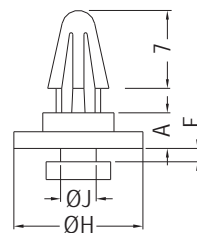

MOUNTING HOLE

PARTNO	A	F	H	J	PACKAGE
ACB-2.5	2.5	1.4	11.5	2.8	1000
ACB-3	3.2	1.2	11.6	3.2	

SPACER SUPPORT

- ◆ MATERIAL: NYLON 66 (UL)
- ◆ FLAME CLASS: 94V-2/94V-0
- ◆ COLOR: NATURAL/BLACK
- ◆ UNIT: mm



P.C.B Ø4.0
THICKNESS: E

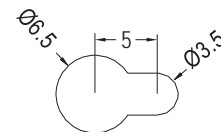
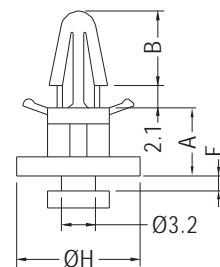

MOUNTING HOLE

PARTNO	A	B	E	F	H	PACKAGE
ACB-5	5.0	7.0	1.6	1.3	11.7	1000
ACB-6	6.3	7.0	1.6	1.3	11.6	
ACB-8	8.0	7.0	1.6	1.4	11.6	
ACB-60	60.0	7.3	1.2-1.7	2.8	11.3	250
ACB-68	68.0	7.3	1.6	1.3	11.3	
ACB-74	74.0	7.3	1.6	1.3	11.3	



SPACER SUPPORT

- ◆ MATERIAL: NYLON 66 (UL)
- ◆ FLAME CLASS: 94V-2/94V-0
- ◆ COLOR: NATURAL/BLACK
- ◆ UNIT: mm



P.C.B Ø4.0
THICKNESS 1.6

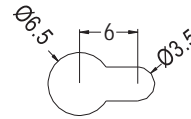
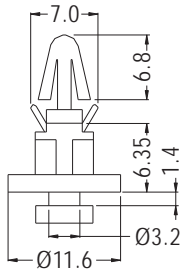

MOUNTING HOLE

PART NO	PACKAGE
MCB-6	500

SPACER SUPPORT

- ◆ MATERIAL: NYLON 66 (UL)
- ◆ FLAME CLASS: 94V-2/94V-0
- ◆ COLOR: NATURAL/BLACK
- ◆ UNIT: mm



P.C.B Ø4.5
THICKNESS 1.2-1.7

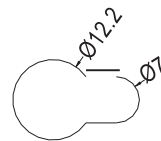
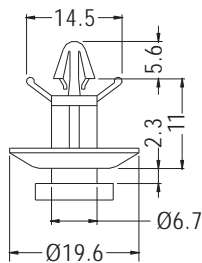

MOUNTING HOLE

PART NO	PACKAGE
MBC-11	500

SPACER SUPPORT

- ◆ MATERIAL: NYLON 66 (UL)
- ◆ FLAME CLASS: 94V-2/94V-0
- ◆ COLOR: NATURAL/BLACK
- ◆ UNIT: mm



P.C.B Ø4.5-Ø4.8
THICKNESS 0.8-2.5

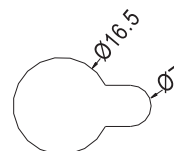
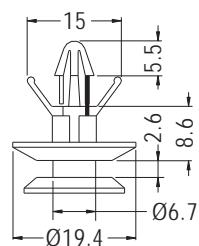

MOUNTING HOLE

PART NO	PACKAGE
MBD-10	500



SPACER SUPPORT

- ◆ MATERIAL: NYLON 66 (UL)
- ◆ FLAME CLASS: 94V-2/94V-0
- ◆ COLOR: NATURAL/BLACK
- ◆ UNIT: mm



P.C.B Ø4.0
THICKNESS 1.2-1.7

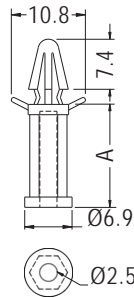

P.C.B Ø4.0
THICKNESS 1.2-1.9

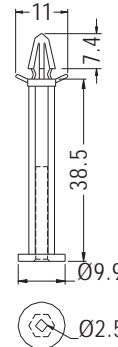

FOR TCBS-38.5

FOR M3 SELF TAPPED SCREW

PART NO	A	PACKAGE
TCBS-5	5.0	1000
TCBS-6A	6.0	
TCBS-6	6.35	
TCBS-7	7.0	
TCBS-9.5	9.5	
TCBS-10	10.0	
TCBS-12.5	12.5	
TCBS-15	15.0	
TCBS-20	20.0	
TCBS-24.5	24.5	
TCBS-25	25.0	
TCBS-26	26.0	
TCBS-30	30.0	
TCBS-35	35.0	
TCBS-38.5	38.5	

1

SPACER SUPPORT

- ◆ MATERIAL: NYLON 66 (UL)
- ◆ FLAME CLASS: 94V-2/94V-0
- ◆ COLOR: NATURAL/BLACK
- ◆ UNIT: mm



P.C.B Ø4.0
THICKNESS 1.2-1.7

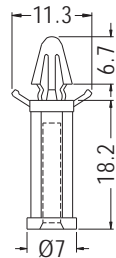

FOR M3 SELF TAPPED SCREW

PART NO	PACKAGE
TCBS-18	1000

SPACER SUPPORT

- ◆ MATERIAL: NYLON 66 (UL)
- ◆ FLAME CLASS: 94V-2/94V-0
- ◆ COLOR: NATURAL/WHITE/BLACK
- ◆ UNIT: mm



THICKNESS 1.2-1.7

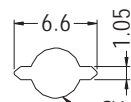
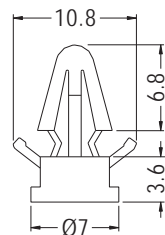

MOUNTING HOLE

THICKNESS 1.2-1.7

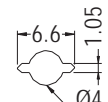
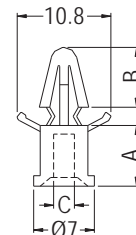

MOUNTING HOLE

FOR SCREW:S

PART NO	PACKAGE
TCBT-3.6	1000

PART NO	THICKNESS	SCREW	PACKAGE	
TCBT-7	7.0	6.9 2.4	4-40 UNC	1000
TCBT-7.7	7.7	5.9 2.6	M3	
TCBT-8.5	8.5	6.9 2.6	M3	
TCBT-16	16.0	6.9 2.4	4-40 UNC	



SPACER SUPPORT

- ◆ MATERIAL: NYLON 66 (UL)
- ◆ FLAME CLASS: 94V-2/94V-0
- ◆ COLOR: NATURAL/BLACK
- ◆ UNIT: mm

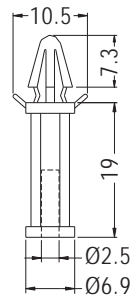

P.C.B THICKNESS 1.2-1.9

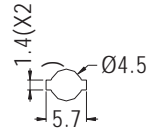

CHASSIS HOLE

PART NO	PACKAGE
TCBT-19	1000

FOR M3 SCREW

SPACER SUPPORT

- ◆ MATERIAL: NYLON 66 (UL)
- ◆ FLAME CLASS: 94V-2/94V-0
- ◆ COLOR: NATURAL/BLACK
- ◆ UNIT: mm



P.C.B Ø4.0
THICKNESS 1.2-1.7

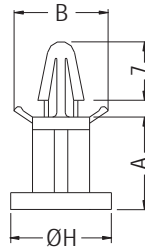

PART NO	A	B	H	PACKAGE
MBS-6	6.4	11.4	11.8	1000
MBS-8	8.0	11.4	11.8	
MBS-8.9	8.9	11.1	11.9	
MBS-8.9S	8.9	11.1	8.0	
MBS-9.5L	9.5	11.4	20.0	
MBS-10	10.0	11.4	12.0	500
MBS-11	11.0	11.4	12.0	
MBS-14	14.0	11.4	12.0	250
MBS-74	74.0	10.4	11.3	

SPACER SUPPORT

- ◆ MATERIAL: NYLON 66 (UL)
- ◆ FLAME CLASS: 94V-2/94V-0
- ◆ COLOR: NATURAL/BLACK
- ◆ UNIT: mm



P.C.B Ø4.5
THICKNESS 1.2-1.7

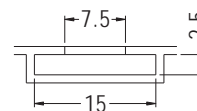
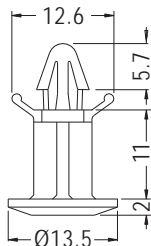

HOLE IN CHASSIS

PART NO	PACKAGE
MTD-11	500

SPACER SUPPORT

- ◆ MATERIAL: NYLON 66 (UL)
- ◆ FLAME CLASS: 94V-2/94V-0
- ◆ COLOR: NATURAL/BLACK
- ◆ UNIT: mm



P.C.B Ø4.0
THICKNESS 1.2-1.7

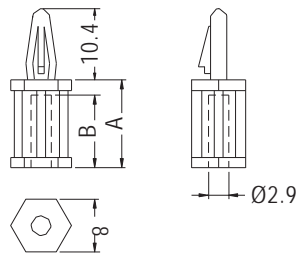

PART NO	A	B	PACKAGE
BS-6	6.4	4.8	1000
★ BS-8	8.0	7.0	
BS-9	9.5	8.0	
BS-10-1	10.0	8.0	
BS-12	12.7	11.0	
BS-14	14.0	12.7	
BS-15S	15.0	13.0	
BS-15	15.9	13.0	
BS-19	19.1	16.2	
BS-20-1	20.0	12.0	
BS-22	22.2	19.4	
BS-25	25.4	24.0	
BS-28	28.6	25.9	
BS-29	29.0	25.9	



P.C.B Ø4.0
THICKNESS 2.0

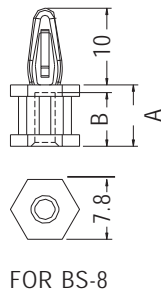

P.C.B Ø4.0
THICKNESS 2.0

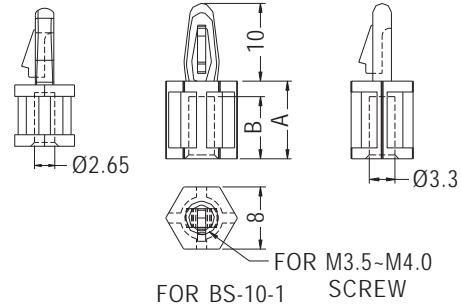

SPACER SUPPORT

- ◆ MATERIAL: NYLON 66 (UL)
- ◆ FLAME CLASS: 94V-2/94V-0
- ◆ COLOR: NATURAL/BLACK
- ◆ UNIT: mm



P.C.B Ø4.0
THICKNESS 1.2-1.7

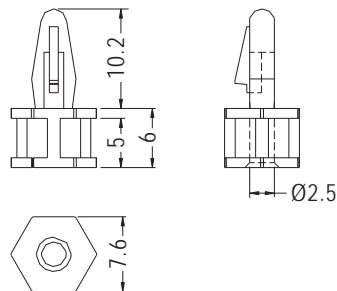

PART NO	PACKAGE
BSB-6	1000

SPACER SUPPORT

- ◆ MATERIAL: NYLON 66 (UL)
- ◆ FLAME CLASS: 94V-2/94V-0
- ◆ COLOR: NATURAL/BLACK
- ◆ UNIT: mm



P.C.B Ø4.2
THICKNESS 1.6

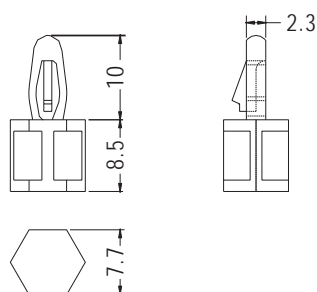

PART NO	PACKAGE
BSB-8.5	1000



SPACER SUPPORT



- ◆ MATERIAL: NYLON 66 (UL)
- ◆ FLAME CLASS: 94V-2/94V-0
- ◆ COLOR: NATURAL/BLACK
- ◆ UNIT: mm

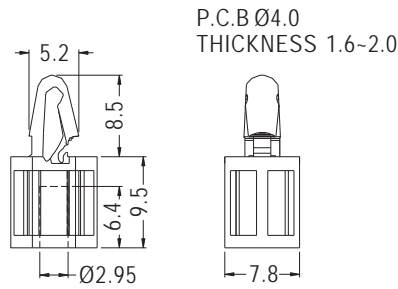

PART NO	PACKAGE
BSCL-9.5	1000

SPACER SUPPORT

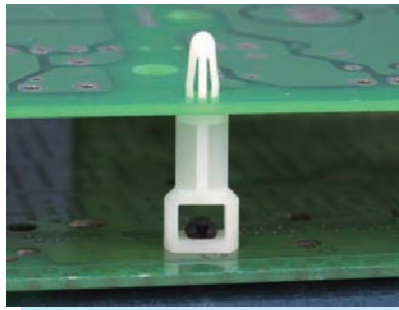

- ◆ MATERIAL: NYLON 66 (UL)
- ◆ FLAME CLASS: 94V-2/94V-0
- ◆ COLOR: NATURAL/BLACK
- ◆ UNIT: mm

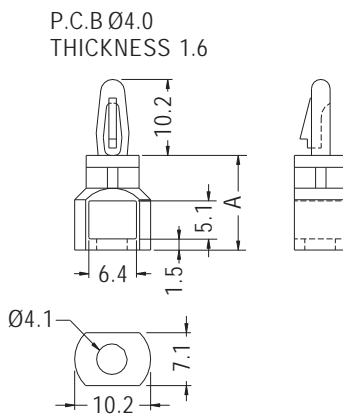

PART NO	A	PACKAGE
SRLCB-9	9.5	1000
SRLCB-11	11.1	
SRLCB-12	12.7	
SRLCB-15	15.9	
SRLCB-19.1	19.1	
SRLCB-22	22.2	
SRLCB-25	25.4	

SPACER SUPPORT

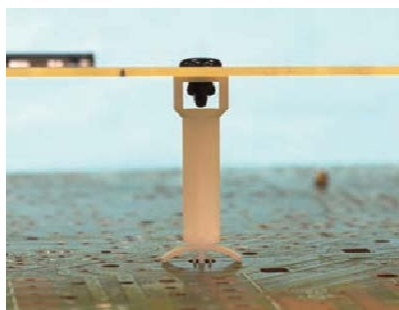

- ◆ MATERIAL: NYLON 66 (UL)
- ◆ FLAME CLASS: 94V-2/94V-0
- ◆ COLOR: NATURAL/BLACK
- ◆ UNIT: mm

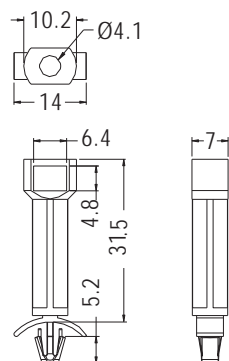

P.C.B Ø4.75-Ø4.8
THICKNESS 0.8-2.0

PART NO	PACKAGE
SRLA-31.5	1000

SPACER SUPPORT

NEW

- ◆ MATERIAL: NYLON 66 (UL)
- ◆ FLAME CLASS: 94V-2/94V-0
- ◆ COLOR: NATURAL/BLACK
- ◆ UNIT: mm

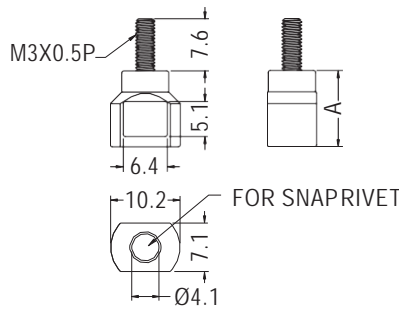
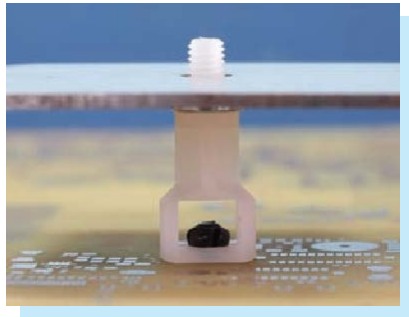

PART NO	A	PACKAGE
TCEB3-9.5	9.5	1000
TCEB3-11.1	11.1	

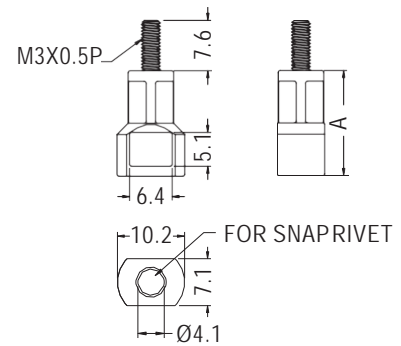

PART NO	A	PACKAGE
TCEB3-12.7	12.7	1000
TCEB3-15.9	15.9	
TCEB3-19.1	19.1	
TCEB3-22.2	22.2	
TCEB3-25.4	25.4	

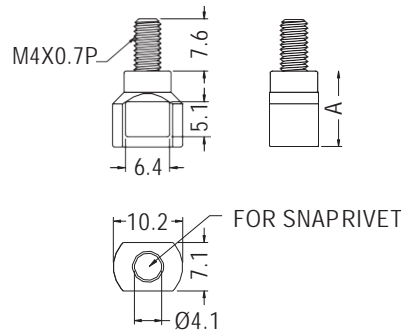

PART NO	A	PACKAGE
TCEB4-9.5	9.5	1000
TCEB4-11.1	11.1	

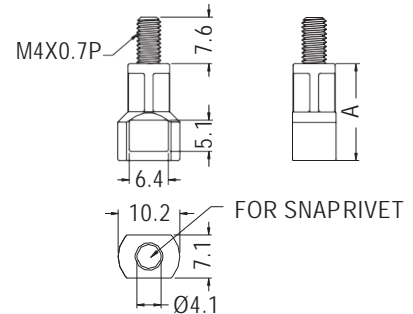

PART NO	A	PACKAGE
TCEB4-12.7	12.7	1000
TCEB4-15.9	15.9	
TCEB4-19.1	19.1	
TCEB4-22.2	22.2	
TCEB4-25.4	25.4	

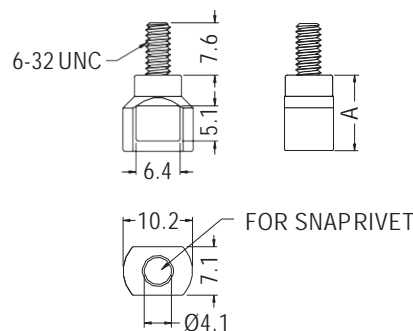

PART NO	A	PACKAGE
TCEB632-9.5	9.5	1000
TCEB632-11.1	11.1	
TCEB632-12.7	12.7	

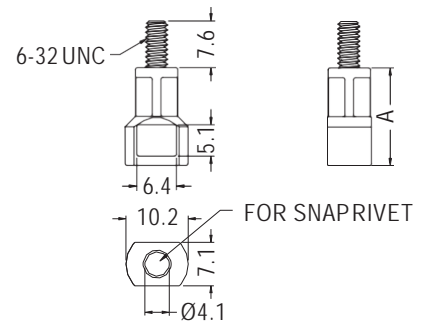

PART NO	A	PACKAGE
TCEB632-12.7	12.7	1000
TCEB632-15.9	15.9	
TCEB632-19.1	19.1	
TCEB632-22.2	22.2	
TCEB632-25.4	25.4	



SPACER SUPPORT



- ◆ MATERIAL: NYLON 66 (UL)
- ◆ FLAME CLASS: 94V-2/94V-0
- ◆ COLOR: NATURAL/BLACK
- ◆ UNIT: mm

P.C.B Ø4.0
 THICKNESS 1.6

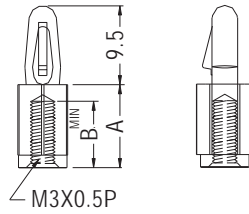

PART NO	A	B	PACKAGE
BSCB-10	10.0	8.0	1000
★ BSCB-12	12.0	8.0	
BSCB-15	15.0	10.0	

SPACER SUPPORT



- ◆ MATERIAL: NYLON 66 (UL)
- ◆ FLAME CLASS: 94V-2/94V-0
- ◆ COLOR: NATURAL/BLACK
- ◆ UNIT: mm

P.C.B Ø4.0
 THICKNESS 1.8

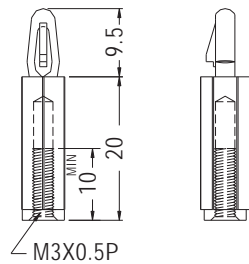

PART NO	PACKAGE
BSCB-20	1000

SPACER SUPPORT



- ◆ MATERIAL: NYLON 66 (UL)
- ◆ FLAME CLASS: 94V-2/94V-0
- ◆ COLOR: NATURAL/BLACK
- ◆ UNIT: mm

HOLE Ø4.0
 THICKNESS 1.6

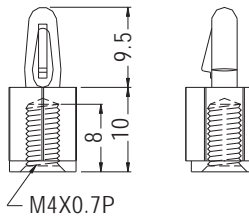

PART NO	PACKAGE
BSCB4-10	1000

SPACER SUPPORT



- ◆ MATERIAL: NYLON 66 (UL)
- ◆ FLAME CLASS: 94V-2/94V-0
- ◆ COLOR: NATURAL/BLACK
- ◆ UNIT: mm

P.C.B Ø4.0
 THICKNESS 1.57

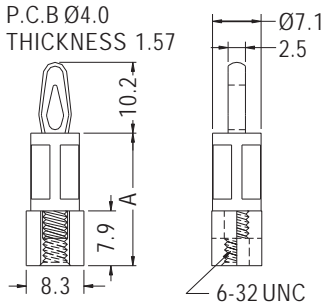

PART NO	A	PACKAGE
BSC632-9.5	9.5	1000
BSC632-12.7	12.7	
BSC632-15.9	15.9	
BSC632-19.1	19.1	
BSC632-22.2	22.2	
BSC632-25.4	25.4	

SPACERSUPPORT



- ◆ MATERIAL: NYLON 66 (UL)
- ◆ FLAME CLASS: 94V-2/94V-0
- ◆ COLOR: NATURAL/BLACK
- ◆ UNIT: mm

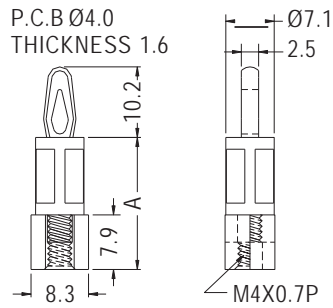

PART NO	A	PACKAGE
BSCM4-9.5	9.5	1000
BSCM4-12.7	12.7	
BSCM4-15.9	15.9	
BSCM4-19.1	19.1	
BSCM4-22.2	22.2	
BSCM4-25.4	25.4	

SPACERSUPPORT



- ◆ MATERIAL: NYLON 66 (UL)
- ◆ FLAME CLASS: 94V-2/94V-0
- ◆ COLOR: NATURAL/BLACK
- ◆ UNIT: mm

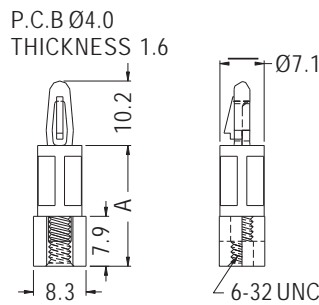

PART NO	A	PACKAGE
BSD632-9.5	9.5	1000
BSD632-12.7	12.7	
BSD632-15.9	15.9	
BSD632-19.1	19.1	
BSD632-22.2	22.2	
BSD632-25.4	25.4	

SPACERSUPPORT



- ◆ MATERIAL: NYLON 66 (UL)
- ◆ FLAME CLASS: 94V-2/94V-0
- ◆ COLOR: NATURAL/BLACK
- ◆ UNIT: mm

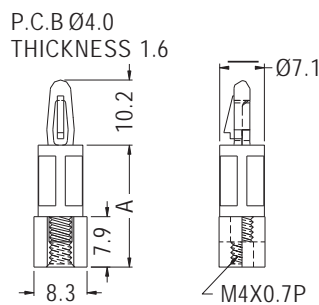

PART NO	A	PACKAGE
BSDM4-9.5	9.5	1000
BSDM4-12.7	12.7	
BSDM4-15.9	15.9	
BSDM4-19.1	19.1	
BSDM4-22.2	22.2	
BSDM4-25.4	25.4	

SPACER SUPPORT



- ◆ MATERIAL: NYLON 66 (UL)
- ◆ FLAME CLASS: 94V-2/94V-0
- ◆ COLOR: NATURAL/BLACK
- ◆ UNIT: mm

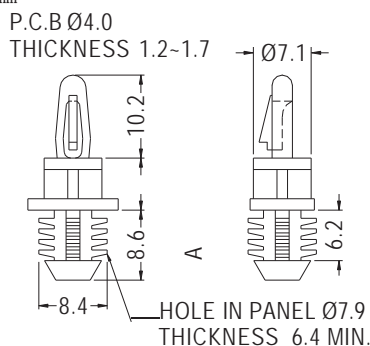

PART NO	A	PACKAGE
WBH-5	4.8	1000
WBH-6	6.4	
WBH-9	9.5	
WBH-11	11.1	
WBH-12	12.7	
WBH-16	15.9	
WBH-19	19.1	
WBH-22	22.2	
WBH-25	25.4	



SPACER SUPPORT

NEW

- ◆ MATERIAL: NYLON 66 (UL)
- ◆ FLAME CLASS: 94V-2/94V-0
- ◆ COLOR: NATURAL/BLACK
- ◆ UNIT: mm

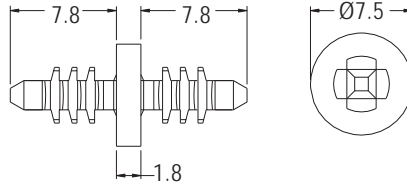

MOUNTING HOLE Ø4.0
THICKNESS 2.6-6.3

PART NO	PACKAGE
WBHB-1.8	1000

1

SPACER SUPPORT

- ◆ MATERIAL: NYLON 66 (UL)
- ◆ FLAME CLASS: 94V-2/94V-0
- ◆ COLOR: NATURAL/BLACK
- ◆ UNIT: mm

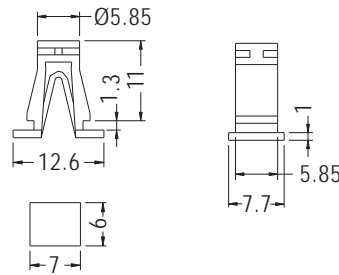

MOUNTING HOLE

PART NO	PACKAGE
PAA-11	1000

SPACER SUPPORT

- ◆ MATERIAL: NYLON 66 (UL)
 - ◆ FLAME CLASS: 94V-2/94V-0
 - ◆ COLOR: NATURAL/BLACK
 - ◆ UNIT: mm
- P.C.B Ø4.0
THICKNESS 0.8-1.7

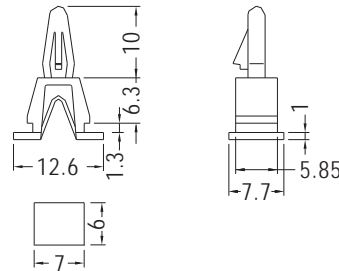

MOUNTING HOLE

PART NO	PACKAGE
PCC-6	2000

SPACER SUPPORT

- ◆ MATERIAL: NYLON 66 (UL)
 - ◆ FLAME CLASS: 94V-2/94V-0
 - ◆ COLOR: NATURAL/BLACK
 - ◆ UNIT: mm
- P.C.B Ø4.0
THICKNESS 1.2-1.7

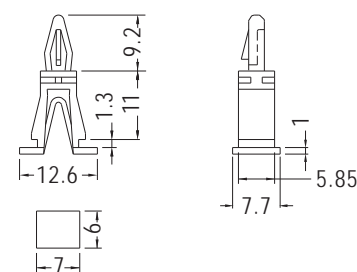

MOUNTING HOLE

PART NO	PACKAGE
PCC-11	1000



SPACER SUPPORT



- ◆ MATERIAL: NYLON 66 (UL)
- ◆ FLAME CLASS: 94V-2/94V-0
- ◆ COLOR: NATURAL/BLACK
- ◆ UNIT: mm

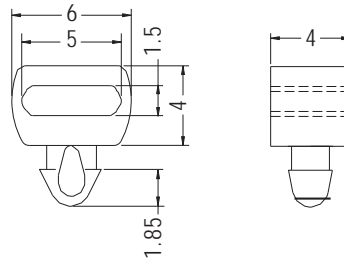

P.C.B Ø2.5
THICKNESS 1.0

PART NO	PACKAGE
LIJ-4	2000

SPACER SUPPORT

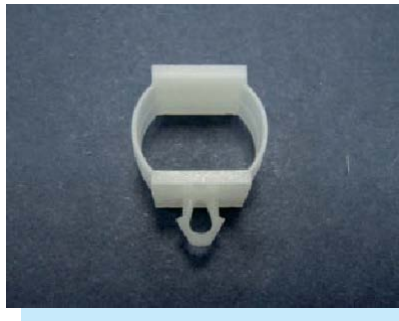

- ◆ MATERIAL: NYLON 66 (UL)
- ◆ FLAME CLASS: 94V-2/94V-0
- ◆ COLOR: NATURAL/BLACK
- ◆ UNIT: mm

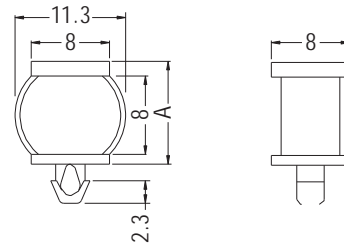

P.C.B Ø3.0
THICKNESS 1.6

PART NO	A	PACKAGE
LIO-10	10.0	2000
LIO-10.5	10.5	

SPACER SUPPORT



- ◆ MATERIAL: NYLON 66 (UL)
- ◆ FLAME CLASS: 94V-2/94V-0
- ◆ COLOR: NATURAL/BLACK
- ◆ UNIT: mm

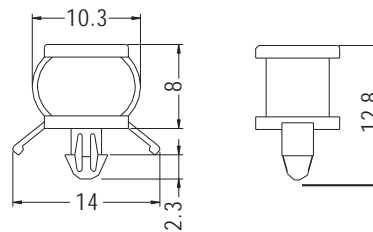

P.C.B Ø3.0
THICKNESS 1.1~1.6

PART NO	PACKAGE
LIO-8	2000

SPACER SUPPORT

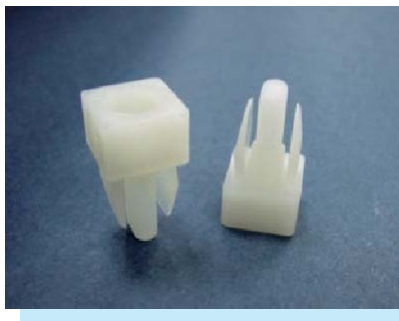

- ◆ MATERIAL: NYLON 66 (UL)
- ◆ FLAME CLASS: 94V-2/94V-0
- ◆ COLOR: NATURAL/BLACK
- ◆ UNIT: mm

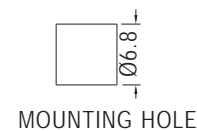
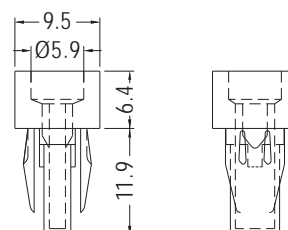

PART NO	PACKAGE
ES-1	1000

SPACER SUPPORT

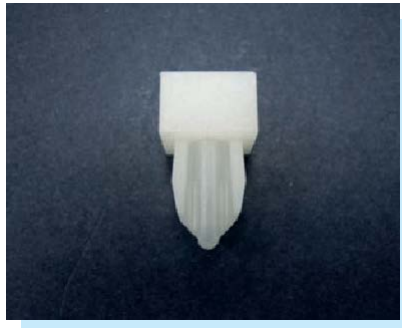

- ◆ MATERIAL: NYLON 66 (UL)
- ◆ FLAME CLASS: 94V-2/94V-0
- ◆ COLOR: NATURAL/BLACK
- ◆ UNIT: mm

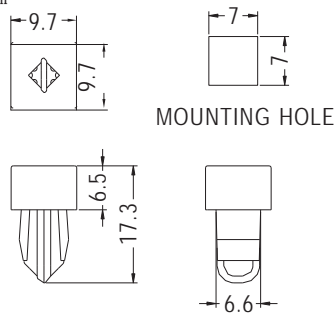

PART NO	PACKAGE
ES-2	1000

SPACER SUPPORT



- ◆ MATERIAL: NYLON 66 (UL)
- ◆ FLAME CLASS: 94V-2/94V-0
- ◆ COLOR: NATURAL/BLACK
- ◆ UNIT: mm

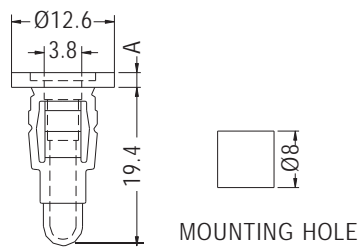

PART NO	A	PACKAGE
YES-08	0.8	500
YES-32	3.2	
YES-48	4.8	

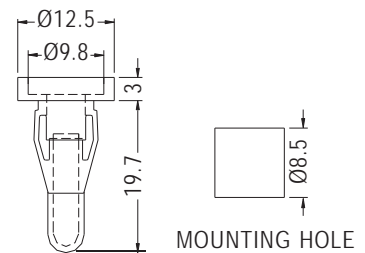

PART NO	PACKAGE
YES-3	500

SPACER SUPPORT

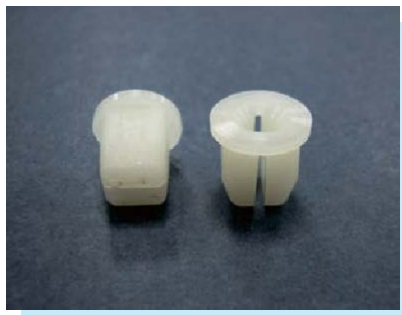

- ◆ MATERIAL: NYLON 66 (UL)
- ◆ FLAME CLASS: 94V-2/94V-0
- ◆ COLOR: NATURAL/BLACK
- ◆ UNIT: mm

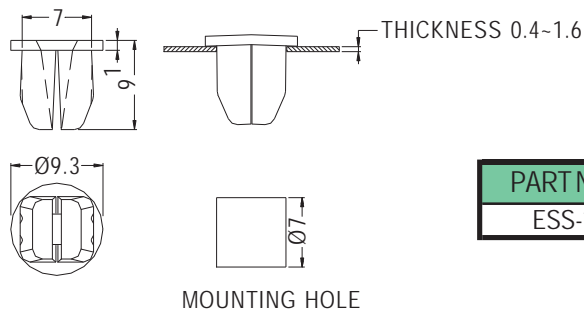

PART NO	PACKAGE
ESS-1	1000

SPACER SUPPORT



- ◆ MATERIAL: NYLON 66 (UL)
- ◆ FLAME CLASS: 94V-2/94V-0
- ◆ COLOR: NATURAL/BLACK
- ◆ UNIT: mm

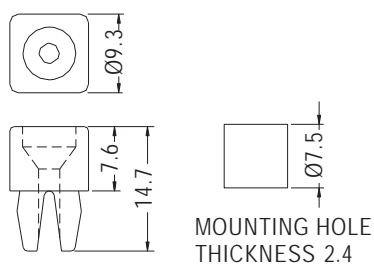

PART NO	PACKAGE
ESS-7.6	1000



SPACERSUPPORT

- ◆ MATERIAL: NYLON 66 (UL)
- ◆ FLAME CLASS: 94V-2/94V-0
- ◆ COLOR: NATURAL/WHITE/BLACK
- ◆ UNIT: mm

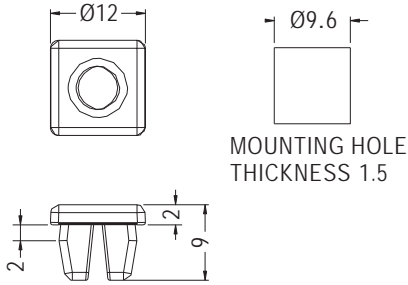

PART NO	PACKAGE
ESS6-2.5	1000

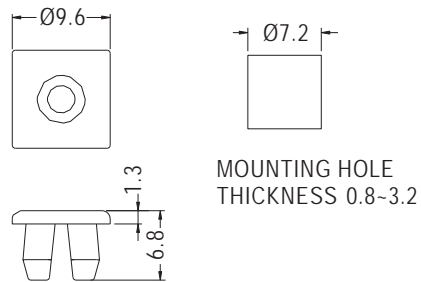

PART NO	PACKAGE
★ ESS-2	1000

SPACER SUPPORT

- ◆ MATERIAL: NYLON 66 (UL)
- ◆ FLAME CLASS: 94V-2/94V-0
- ◆ COLOR: NATURAL/BLACK
- ◆ UNIT: mm

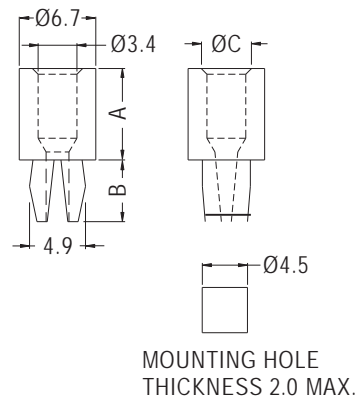

PART NO	A	B	C	PACKAGE
ETS-3	3.0	5.4	4.4	2000
ETS-3-1	3.0		5.0	
ETS-3.2	3.2		4.4	
ETS-3.2-1	3.2		5.0	
ETS-3.4	3.4		4.4	
ETS-3.6	3.6		5.0	
ETS-4.6	4.6	4.0	4.4	1000
ETS-4.8	4.8			
ETS-6.3	6.3			
ETSS-6.5	6.5			
ETS-8	8.0			
ETS-10	10.0			
ETS-12	12.7			
ETS-16	15.9			
ETS-19	19.1			

SPACERSUPPORT

- ◆ MATERIAL: NYLON 66 (UL)
- ◆ FLAME CLASS: 94V-2/94V-0
- ◆ COLOR: NATURAL/BLACK/ORANGE
- ◆ UNIT: mm

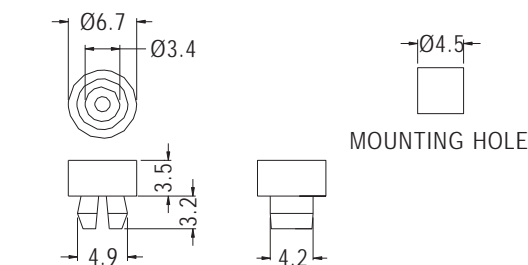

PART NO	PACKAGE
ETSA-3.5	1000



SPACERSUPPORT

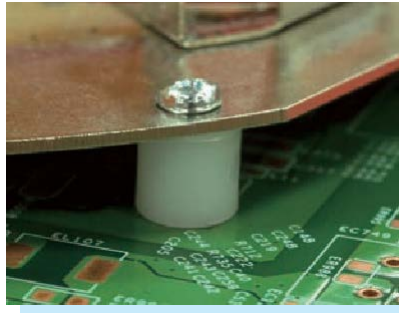

- ◆ MATERIAL: NYLON 66 (UL)
- ◆ FLAME CLASS: 94V-2/94V-0
- ◆ COLOR: NATURAL/BLACK
- ◆ UNIT: mm

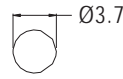
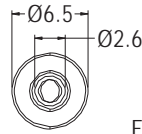

MOUNTING HOLE FOR M2.5-M2.6 SCREW

MOUNTING HOLE THICKNESS 1.6

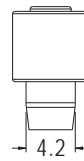
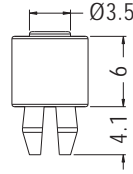

PART NO	PACKAGE
ETSB-6	1000

SPACER SUPPORT

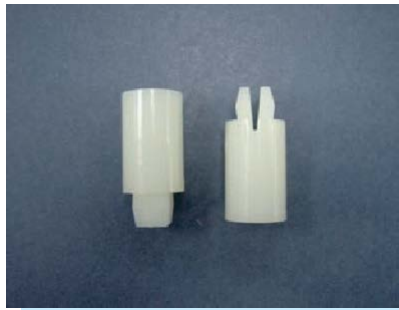

- ◆ MATERIAL: NYLON 66 (UL)
- ◆ FLAME CLASS: 94V-2/94V-0
- ◆ COLOR: NATURAL/BLACK
- ◆ UNIT: mm

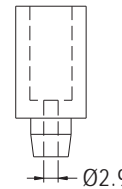
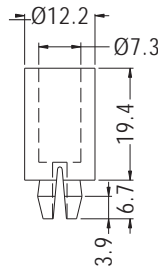

MOUNTING HOLE THICKNESS 2.0

PART NO	PACKAGE
ESS-19	1000

SPACER SUPPORT



- ◆ MATERIAL: NYLON 66 (UL)
- ◆ FLAME CLASS: 94V-2/94V-0
- ◆ COLOR: NATURAL/WHITE/BLACK
- ◆ UNIT: mm

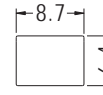
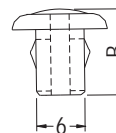
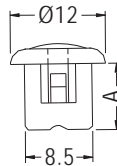

MOUNTING HOLE THICKNESS 0.8-2.0

PART NO	A	B	PACKAGE
LHC-8	8.4	10.8	1000
LHC-12	12.5	14.9	

SPACERSUPPORT

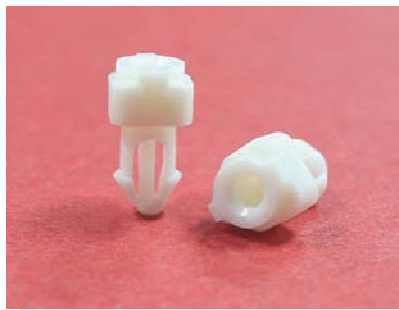

- ◆ MATERIAL: NYLON 66 (UL)
- ◆ FLAME CLASS: 94V-2/94V-0
- ◆ COLOR: NATURAL/BLACK
- ◆ UNIT: mm

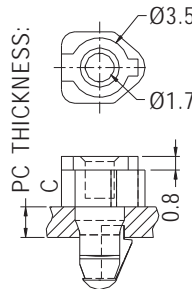

MOUNTING HOLE Ø3.0 THICKNESS: E

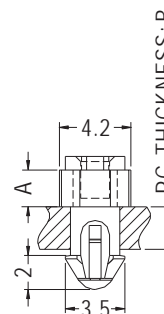

PART NO	A	B	C	E	PACKAGE
BSE-2.2	2.16	2.5	1.6	1.6 or 2.5	1000
★ BSE-2.2L	2.2	3.3	2.0	1.7-3.05	



SPACER SUPPORT

- ◆ MATERIAL: NYLON 66 (UL)
- ◆ FLAME CLASS: 94V-2/94V-0
- ◆ COLOR: NATURAL/BLACK
- ◆ UNIT: mm



P.C.B Ø3.0
THICKNESS: E

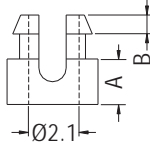

FOR M2 SCREW

PART NO	A	B	E	PACKAGE
SS1-2	2.0	1.2	0.8~1.0	2000
SS1-2.5	2.5			
SS1-3	3.0			
SS1-3.5	3.5			
SS1-4	4.0			
SS1-4.5	4.5			
SS1-5	5.0			
SS1-5.5	5.5			
SS1-6	6.0			

PART NO	A	B	E	PACKAGE
SS1-2S	2.0	0.5	0.8~1.0	2000
SS1-2.5S	2.5			
SS1-3S	3.0			
SS1-3.5S	3.5			
SS1-4S	4.0			
SS1-4.5S	4.5			
SS1-5S	5.0			
SS1-5.5S	5.5			
SS1-6S	6.0			
SS1-2L	2.0			
SS1-2.5L	2.5			
SS1-3L	3.0			
SS1-3.5L	3.5			
SS1-4L	4.0			
SS1-4.5L	4.5			
SS1-5L	5.0			
SS1-5.5L	5.5			
SS1-6L	6.0			
SS1-8L	8.0			

SPACER SUPPORT

- ◆ MATERIAL: NYLON 66 (UL)
- ◆ FLAME CLASS: 94V-2/94V-0
- ◆ COLOR: NATURAL/BLACK
- ◆ UNIT: mm



P.C.B Ø3.0
THICKNESS 1.3

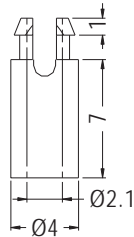

FOR M2 SCREW

PART NO	PACKAGE
SS3-7(1.3)	1000

SPACER SUPPORT

- ◆ MATERIAL: NYLON 66 (UL)
- ◆ FLAME CLASS: 94V-2/94V-0
- ◆ COLOR: NATURAL/BLACK
- ◆ UNIT: mm

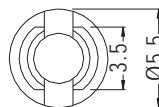

P.C.B Ø4.0
THICKNESS: E

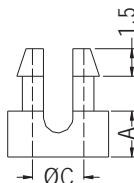

FOR SCREW: S

PART NO	A	C	E	S	PACKAGE	
SS2-2.5S	2.5	2.7	1.6	M2.6	2000	
SS2-3S	3.0					
SS2-4S	4.0					
SS2-5S	5.0					
SS2-6S	6.0					
SS2-2.5U	2.5	2.8	1.6~1.8	M2		2000
SS2-2.5	2.5					
SS2-3	3.0					
SS2-4	4.0					
SS2-5	5.0					
SS2-5.4	5.4					
SS2-6	6.0					
SS2-8	8.0					
SS2-9.5	9.5					



SPACER SUPPORT

- ◆ MATERIAL: NYLON 66 (UL)
- ◆ FLAME CLASS: 94V-2/94V-0
- ◆ COLOR: NATURAL/BLACK
- ◆ UNIT: mm



P.C.B Ø4.8
THICKNESS 1.2-1.7

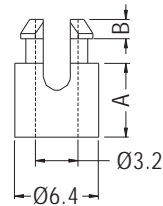

FOR M3 SCREW

PART NO	A	B	PACKAGE
SS-3	3.2	1.5	1000
SS-3.5	3.5	1.5	
SS-4	4.0	1.5	
SS-4.5	4.5	1.5	
SS-5	4.8	1.5	
SS-6	6.4	1.5	
SS-7	7.0	1.7	
SS-7.4	7.4	1.7	
SS-8	7.9	1.5	

PART NO	A	B	PACKAGE	
SS-10	9.5	1.5	1000	
SS-10A	9.5	1.7		
SS-11	11.1	1.5		
SS-12A	12.0	1.5		
SS-12	12.7	1.5		
SS-14	14.2	1.5		
SS-15	15.0	1.5		
SS-16	15.9	1.5		
SS-19	19.1	1.5		
SS-22	22.2	1.5		500
SS-25	25.4	1.5		

SPACERSUPPORT

- ◆ MATERIAL: NYLON 66 (UL)
- ◆ FLAME CLASS: 94V-2/94V-0
- ◆ COLOR: NATURAL/BLACK
- ◆ UNIT: mm



P.C.B Ø4.8
THICKNESS 1.6

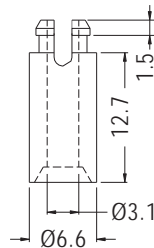

PART NO	PACKAGE
SSA-12.7	1000

SPACERSUPPORT

- ◆ MATERIAL: NYLON 66 (UL)
- ◆ FLAME CLASS: 94V-2/94V-0
- ◆ COLOR: NATURAL/BLACK
- ◆ UNIT: mm



P.C.B Ø5.8
THICKNESS 1.6

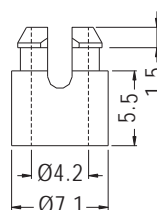

PART NO	PACKAGE
SSA4-5.5	1000



SPACER SUPPORT

- ◆ MATERIAL: NYLON 66 (UL)
- ◆ FLAME CLASS: 94V-2/94V-0
- ◆ COLOR: NATURAL/BLACK
- ◆ UNIT: mm



P.C.B Ø5.9
THICKNESS 1.2~1.7

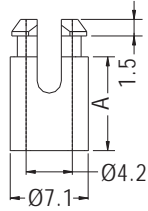

FOR M3.5 OR M4 SCREW

PART NO	A	PACKAGE
SS4-3	3.0	1000
SS4-4	4.0	
SS4-4.6	4.6	
SS4-5	5.0	
SS4-6	6.4	
SS4-8	7.9	
SS4-9	9.5	
SS4-11	11.1	
SS4-12S	12.0	
SS4-12	12.7	
SS4-16	15.9	
SS4-17	17.0	
SS4-19	19.1	
SS4-22	22.2	
SS4-25	25.4	
SS4-30	30.0	



SPACER SUPPORT

- ◆ MATERIAL: NYLON 66 (UL)
- ◆ FLAME CLASS: 94V-2/94V-0
- ◆ COLOR: NATURAL/BLACK
- ◆ UNIT: mm



P.C.B Ø5.9
THICKNESS 1.2~1.7

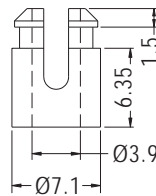

PART NO	PACKAGE
SSU4-6.3	1000

SPACER SUPPORT

- ◆ MATERIAL: NYLON 66 (UL)
- ◆ FLAME CLASS: 94V-2/94V-0
- ◆ COLOR: NATURAL/BLACK
- ◆ UNIT: mm



P.C.B Ø5.9
THICKNESS 1.8

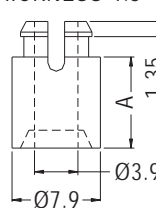

FOR M3.5 SCREW

PART NO	A	PACKAGE
SS3.5-6.3	6.3	1000
SS3.5-9.5	9.5	
SS3.5-12.7	12.7	
SS3.5-15	15.9	

SPACER SUPPORT

- ◆ MATERIAL: NYLON 66 (UL)
- ◆ FLAME CLASS: 94V-2/94V-0
- ◆ COLOR: NATURAL/BLACK
- ◆ UNIT: mm

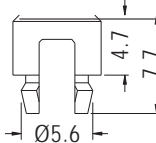

CHASSIS Ø5.0
THICKNESS 0.8

PART NO	PACKAGE
CUS-5	2000



SPACER SUPPORT



- ◆ MATERIAL: NYLON 66 (UL)
- ◆ FLAME CLASS: 94V-2/94V-0
- ◆ COLOR: NATURAL/BLACK
- ◆ UNIT: mm

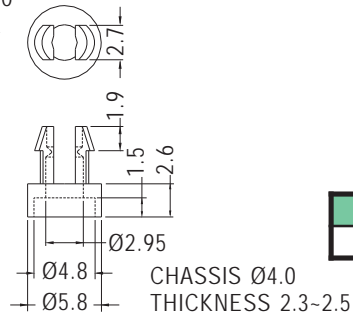

PART NO	PACKAGE
SOR-2	2000

SPACER SUPPORT



- ◆ MATERIAL: NYLON 66 (UL)
- ◆ FLAME CLASS: 94V-2/94V-0
- ◆ COLOR: NATURAL/BLACK
- ◆ UNIT: mm

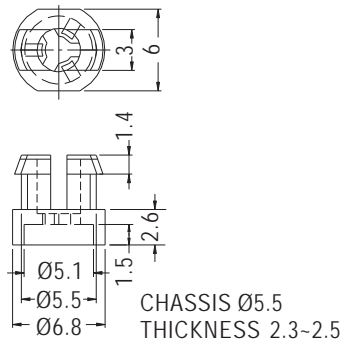

PART NO	PACKAGE
SOR-1	2000

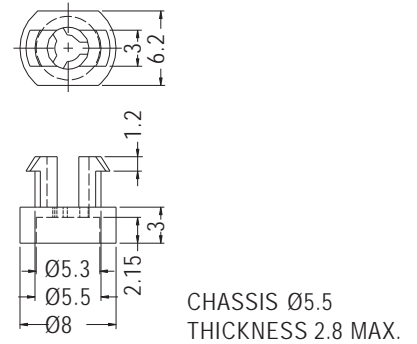

PART NO	PACKAGE
★ SOR-3	2000

SPACER SUPPORT



- ◆ MATERIAL: NYLON 66 (UL)
- ◆ FLAME CLASS: 94V-2/94V-0
- ◆ COLOR: NATURAL/BLACK
- ◆ UNIT: mm

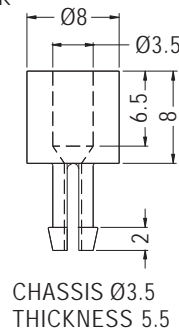

PART NO	PACKAGE
SSUL-8	1000

SPACER SUPPORT



- ◆ MATERIAL: NYLON 66 (UL)
- ◆ FLAME CLASS: 94V-2/94V-0
- ◆ COLOR: NATURAL/BLACK
- ◆ UNIT: mm

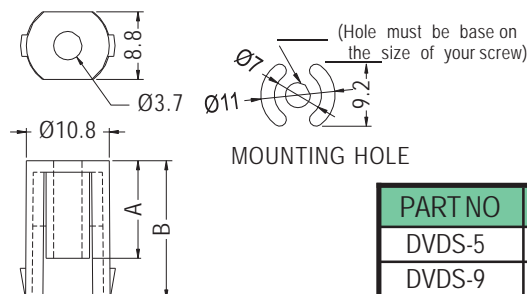

PART NO	A	B	PACKAGE
DVDS-5	5.0	7.8	500
DVDS-9	9.4	14.7	
DVDS-12	12.7	18.1	

SPACER SUPPORT



- ◆ MATERIAL: NYLON 66 (UL)
- ◆ FLAME CLASS: 94V-2/94V-0
- ◆ COLOR: NATURAL/BLACK
- ◆ UNIT: mm

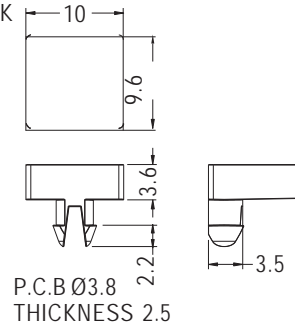

PART NO	PACKAGE
LIES-1	1000

SPACER SUPPORT

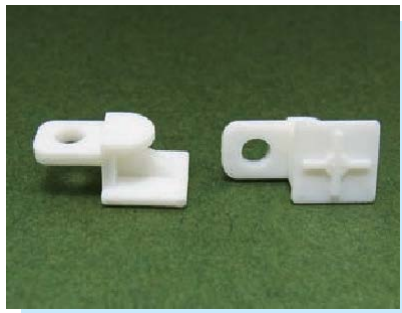

- ◆ MATERIAL: NYLON 66 (UL)
- ◆ FLAME CLASS: 94V-2/94V-0
- ◆ COLOR: NATURAL/BLACK
- ◆ UNIT: mm

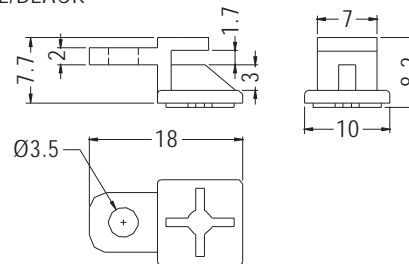

PART NO	PACKAGE
UBD-1	1000

SPACER SUPPORT

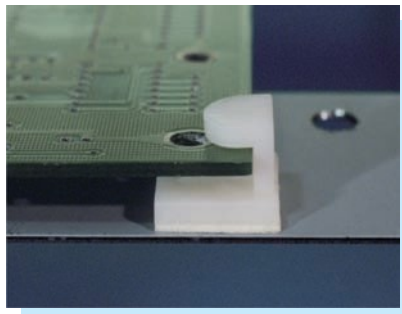

- ◆ MATERIAL: NYLON 66 (UL)
- ◆ FLAME CLASS: 94V-2/94V-0
- ◆ COLOR: NATURAL/BLACK
- ◆ UNIT: mm

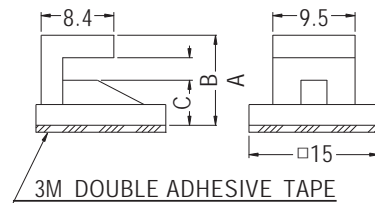

PART NO	A	B	C	PACKAGE
UB-6A	10.4	2.6	5.1	1000
UB-8A	11.9	2.4	7.0	
UB-10A	14.1	2.5	9.1	
UB-11A	15.0	2.5	10.0	
UB-12A	16.1	2.5	11.1	

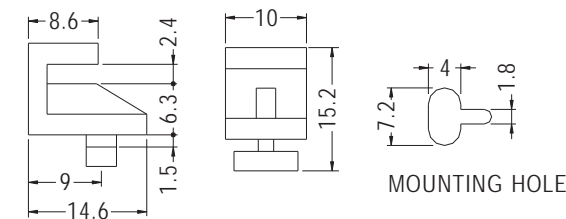
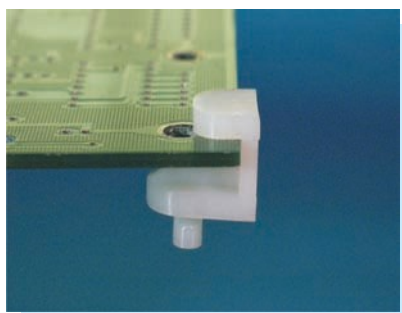

PART NO	PACKAGE
UB-6E	1000

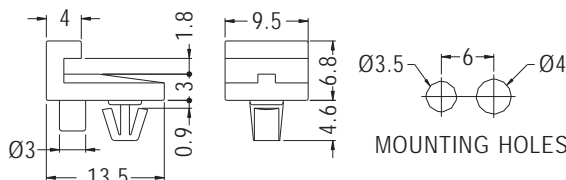
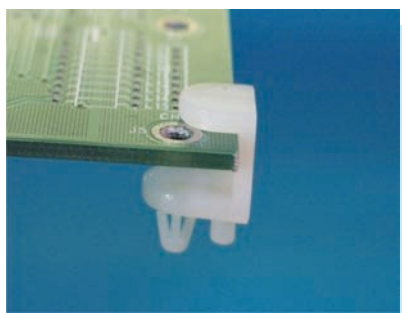

PART NO	PACKAGE
UB-3S	1000

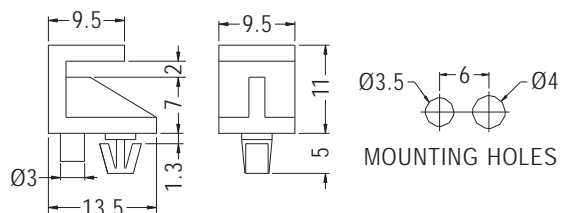

PART NO	PACKAGE
UB-6	1000



SPACER SUPPORT

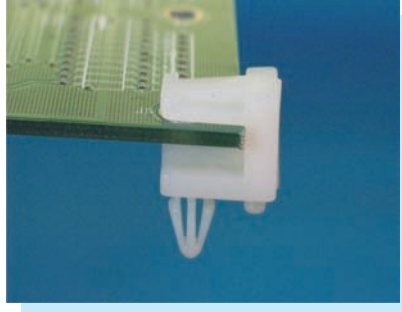

MATERIAL: NYLON 66 (UL)
FLAME CLASS: 94V-2/94V-0
COLOR: NATURAL/BLACK
UNIT:

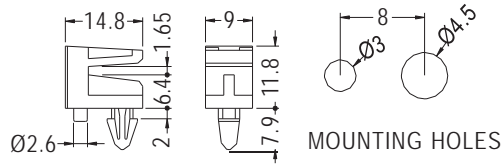

PART NO	PACKAGE
UB-6D	1000

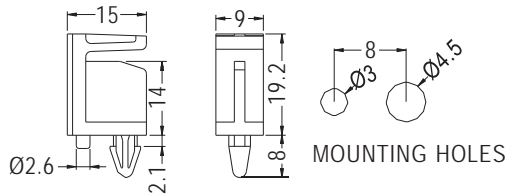

PART NO	PACKAGE
UB-14D	1000

SPACER SUPPORT

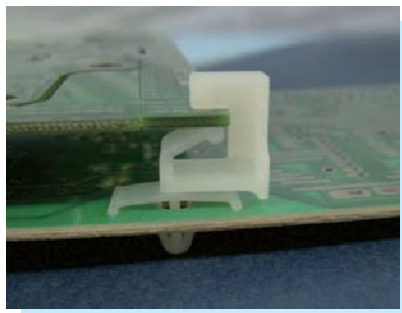

MATERIAL: NYLON 66 (UL)
FLAME CLASS: 94V-2/94V-0
COLOR: NATURAL/BLACK
UNIT:

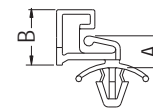
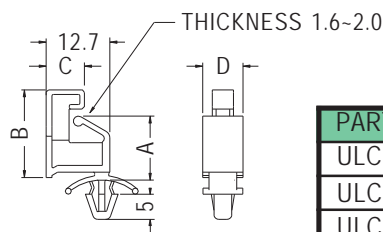

FOR ULCF-6~ULCF-8S

PART NO	A	B	C	D	PACKAGE
ULCF-6	6.3	11.0	9.0	8.0	1000
ULCF-8	8.0	12.7	9.0	8.0	
ULCF-8S	8.0	12.7	7.6	6.0	
ULCF-9	9.5	14.2	9.0	8.0	
ULCF-12	12.7	17.4	9.0	8.0	
ULCF-16	15.9	20.6	9.0	8.0	

SPACER SUPPORT



MATERIAL: NYLON 66 (UL)
FLAME CLASS: 94V-2/94V-0
COLOR: NATURAL/BLACK
UNIT:

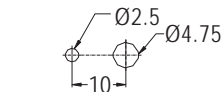
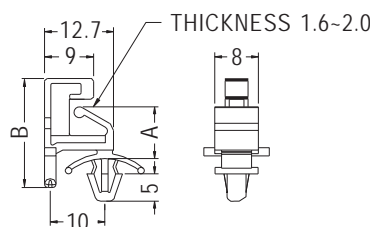

MOUNTING HOLES

PART NO	A	B	PACKAGE
WLCF-6	6.3	16.8	1000
WLCF-8	8.0	18.5	
WLCF-9	9.5	20.0	
WLCF-12	12.7	23.2	
WLCF-16	15.9	26.4	

SPACER SUPPORT

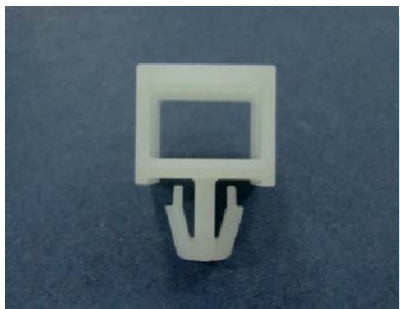

MATERIAL: NYLON 66 (UL)
FLAME CLASS: 94V-2/94V-0
COLOR: NATURAL/BLACK
UNIT:

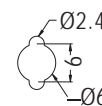
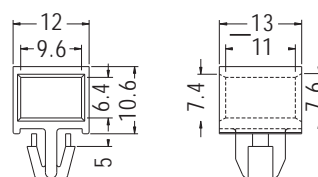

MOUNTING HOLE
THICKNESS: E

PART NO	E	PACKAGE
LDD-10	1.6~1.8	500
LDD-10(2)	1.8~2.0	

SPACER SUPPORT

- ◆ MATERIAL: NYLON 66 (UL)
- ◆ FLAME CLASS: 94V-2/94V-0
- ◆ COLOR: NATURAL/BLACK
- ◆ UNIT: mm

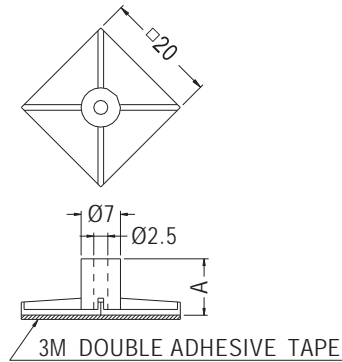
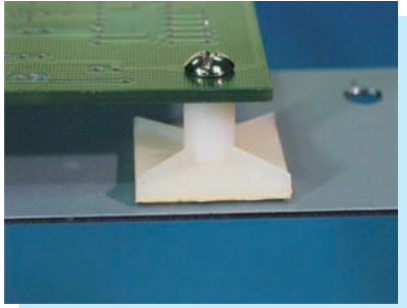

PART NO	A	PACKAGE
ASR-5	4.2	500
ASR-6	5.6	
ASR-7	6.2	
ASR-8	7.2	
ASR-9	8.2	
ASR-11	10.0	
ASR-12.7	11.9	
ASR-14.5	13.6	
ASR-15.9	15.1	
ASR-17.5	16.3	
ASR-19.1	18.3	

SPACER SUPPORT

- ◆ MATERIAL: NYLON 66 (UL)
- ◆ FLAME CLASS: 94V-2/94V-0
- ◆ COLOR: NATURAL/BLACK
- ◆ UNIT: mm

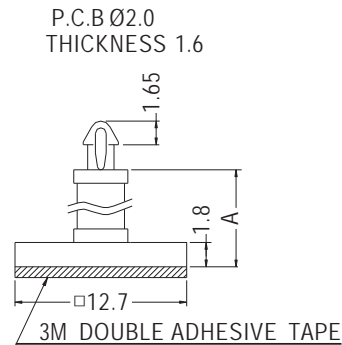
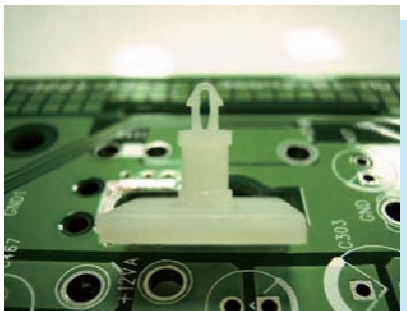

PART NO	A	PACKAGE
ISS-4.8	4.0	1000
ISS-6.4	5.6	
ISS-8	7.2	
ISS-9.5	8.7	
ISS-11.1	10.3	
ISS-12.7	11.9	
ISS-15.9	15.1	
ISS-19.1	18.3	

SPACER SUPPORT

- ◆ MATERIAL: NYLON 66 (UL)
- ◆ FLAME CLASS: 94V-2/94V-0
- ◆ COLOR: NATURAL/BLACK
- ◆ UNIT: mm

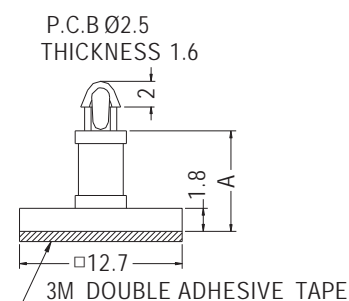

PART NO	A	PACKAGE
GSS-4.8	4.0	1000
GSS-6.4	5.6	
GSS-8	7.2	
GSS-9.5	8.7	
GSS-11.1	10.3	
GSS-12.7	11.9	
GSS-14.3	13.5	
GSS-15.9	15.1	
GSS-19.1	18.3	

SPACER SUPPORT

- ◆ MATERIAL:NYLON 66(UL)
- ◆ FLAME CLASS:94V-2/94V-0
- ◆ COLOR:NATURAL/BLACK
- ◆ UNIT:mm

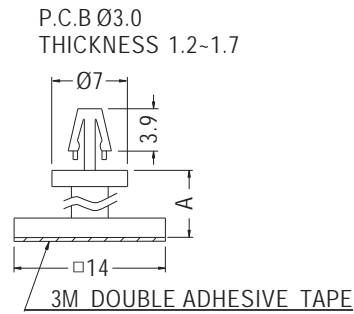

PARTNO	A	PACKAGE
BSS-6	5.6	1000
BSS-9	8.0	
BSS-12	11.9	

SPACER SUPPORT

- ◆ MATERIAL:NYLON 66(UL)
- ◆ FLAME CLASS:94V-2/94V-0
- ◆ COLOR:NATURAL/BLACK
- ◆ UNIT:mm

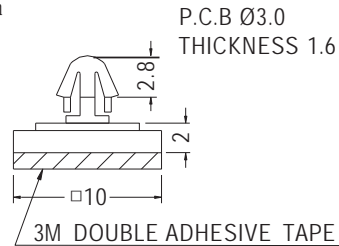

PARTNO	PACKAGE
CSSA-2	1000

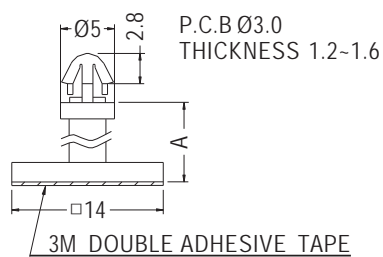

PARTNO	A	PACKAGE
CSS-3.5	2.7	1000
CSS-5	4.0	
CSS-6.4	5.6	
CSS-8	7.2	
CSS-10	9.2	
CSS-11	9.7	
CSS-12.7	11.9	

SPACER SUPPORT

- ◆ MATERIAL:NYLON 66(UL)
- ◆ FLAME CLASS:94V-2/94V-0
- ◆ COLOR:NATURAL/BLACK
- ◆ UNIT:mm

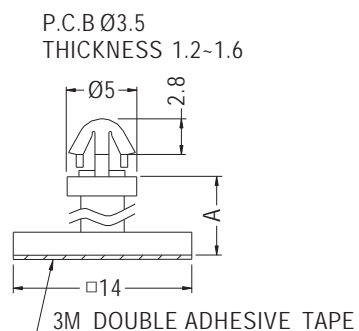

PARTNO	A	PACKAGE
FSS-3.5	2.7	1000
FSS-5	4.0	
FSS-6.4	5.6	
FSS-8	7.2	
FSS-10	9.2	500
FSS-12.7	11.9	1000

SPACER SUPPORT

- ◆ MATERIAL: NYLON 66 (UL)
- ◆ FLAME CLASS: 94V-2/94V-0
- ◆ COLOR: NATURAL/BLACK
- ◆ UNIT: mm



P.C.B Ø3.5
THICKNESS 1.2-1.6

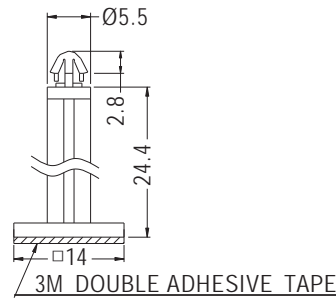

PART NO	PACKAGE
FSL-25	1000

SPACER SUPPORT

- ◆ MATERIAL: NYLON 66 (UL)
- ◆ FLAME CLASS: 94V-2/94V-0
- ◆ COLOR: NATURAL/BLACK
- ◆ UNIT: mm

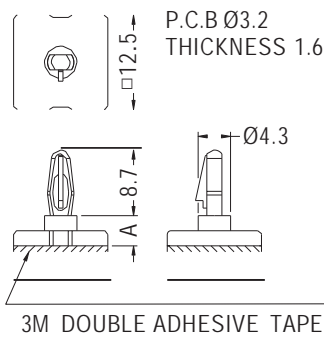

PART NO	A	PACKAGE
JSS-4.8	4.0	500
JSS-6.4	5.6	
JSS-7.9	6.8	
JSS-8.4	7.5	
JSS-9.5	8.5	
JSS-11	10.6	
JSS-12.7	11.7	
JSS-15.9	15.0	

SPACER SUPPORT

- ◆ MATERIAL: NYLON 66 (UL)
- ◆ FLAME CLASS: 94V-2/94V-0
- ◆ COLOR: NATURAL/BLACK
- ◆ UNIT: mm

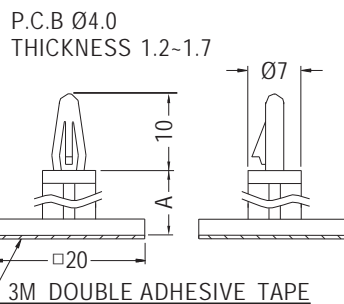

PART NO	A	PACKAGE
ASS-5	4.6	500
ASS-6	5.5	
ASS-8	7.2	
ASS-10	9.0	
ASS-12	12.0	
ASS-15	15.4	

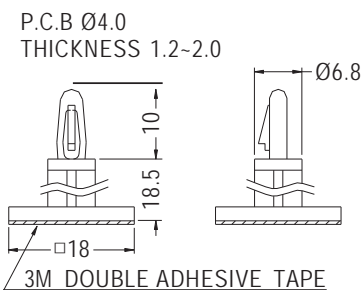

PART NO	PACKAGE
ASS-18.5	500



SPACER SUPPORT

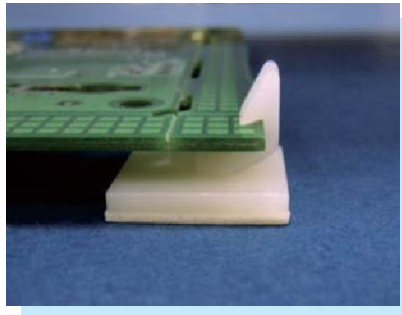

- ◆ MATERIAL: NYLON 66 (UL)
- ◆ FLAME CLASS: 94V-2/94V-0
- ◆ COLOR: NATURAL/BLACK
- ◆ UNIT: mm

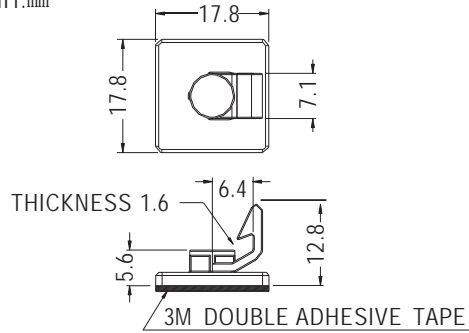

PART NO	PACKAGE
ULCK-6.4	1000

PC SPACER SUPPORT



- ◆ MATERIAL: NYLON 66 (UL)
- ◆ FLAME CLASS: 94V-2/94V-0
- ◆ COLOR: NATURAL/BLACK/DEEP BLUE
- ◆ UNIT: mm

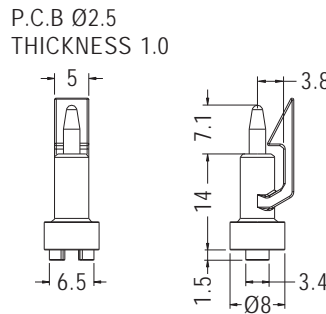

PART NO	PACKAGE
ULCI-11	1000

SPACER SUPPORT



- ◆ MATERIAL: NYLON 66 (UL)
- ◆ FLAME CLASS: 94V-2/94V-0
- ◆ COLOR: NATURAL/BLACK
- ◆ UNIT: mm

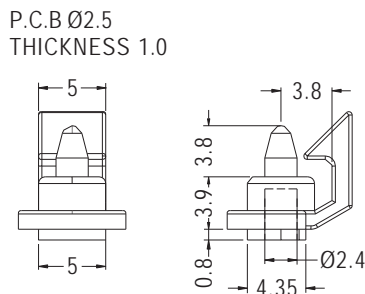

PART NO	PACKAGE
ULCIJ-4	1000

SPACER SUPPORT



- ◆ MATERIAL: NYLON 66 (UL)
- ◆ FLAME CLASS: 94V-2/94V-0
- ◆ COLOR: NATURAL/BLACK
- ◆ UNIT: mm

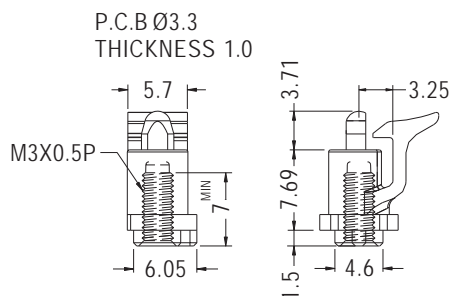

PART NO	PACKAGE
ULCD-7.8	1000

SPACER SUPPORT

- ◆ MATERIAL: NYLON 66 (UL)
- ◆ FLAME CLASS: 94V-2/94V-0
- ◆ COLOR: NATURAL/BLACK/GREEN
- ◆ UNIT: mm

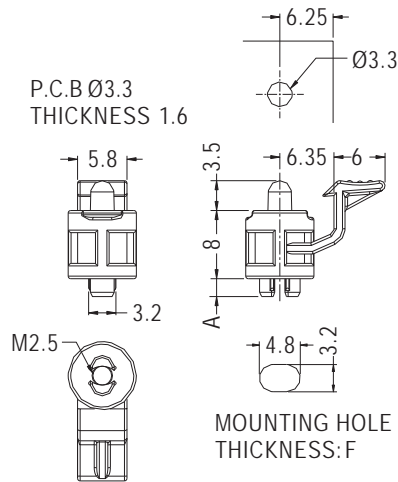
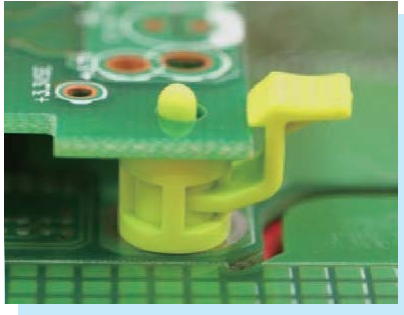

PART NO	A	F	PACKAGE
ULCH-2	2.1	2.16	1000
ULCH-2S	1.5	1.6	

SPACER SUPPORT

- ◆ MATERIAL: NYLON 66 (UL)
- ◆ GROUND TERMINAL MATERIAL: SPTe
- ◆ FLAME CLASS: 94V-2/94V-0
- ◆ COLOR: NATURAL/BLACK/BLUE
- ◆ UNIT: mm

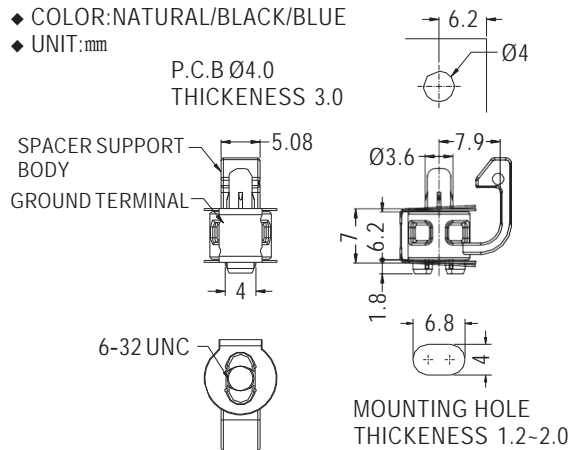

PART NO	PACKAGE
ULCH-1	1000

SPACER SUPPORT

- ◆ MATERIAL: NYLON 66 (UL)
- ◆ FLAME CLASS: 94V-2/94V-0
- ◆ COLOR: NATURAL/BLACK
- ◆ UNIT: mm

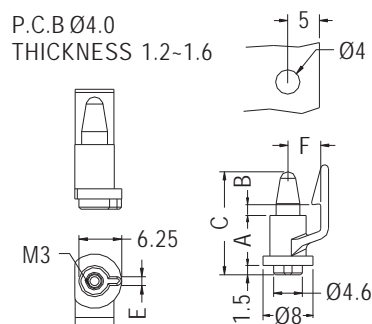

PART NO	A	B	C	E	F	PACKAGE
ULCC-6	6.3	1.73	14.8	1.3	5.25	500
ULCC-8	8.0	1.7	16.5			
ULCC-10	10.0	2.24	19.0	1.4		
ULCC-12	12.0	1.75	19.8			
ULCC-19	18.55	1.9	27.05	1.3		



SPACER SUPPORT

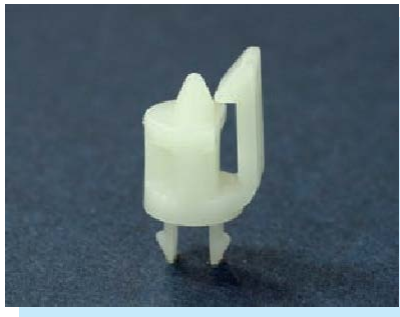

- ◆ MATERIAL: NYLON 66 (UL)
- ◆ FLAME CLASS: 94V-2/94V-0
- ◆ COLOR: NATURAL/BLACK
- ◆ UNIT: mm

P.C.B Ø3.3
THICKNESS 1.57

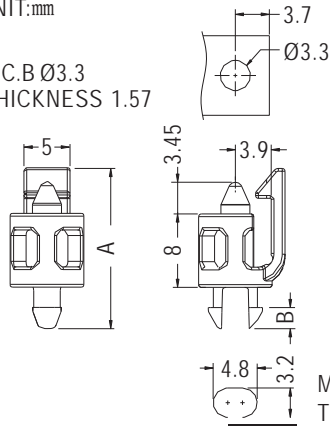

PARTNO	A	B	T	PACKAGE
ULCSA-8	17.45	2.3	2.13	1000
ULCSA-8S	16.5	1.9	1.57	

MOUNTING HOLE
THICKNESS: T



P.C.B Ø3.3
THICKNESS 1.57

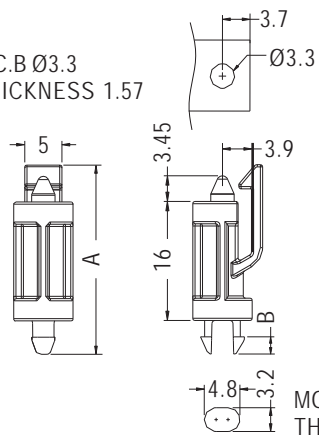

PARTNO	A	B	T	PACKAGE
ULCSA-16	25.45	2.3	2.13	1000
ULCSA-16S	24.5	1.9	1.57	

MOUNTING HOLE
THICKNESS: T

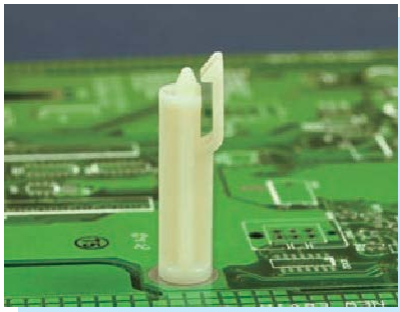

P.C.B Ø3.3
THICKNESS 1.57

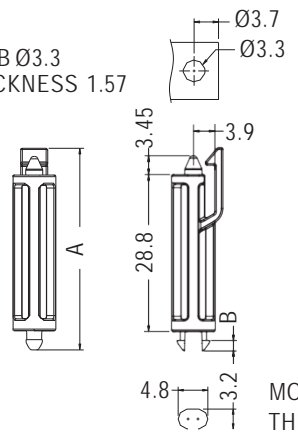

PART NO	A	B	T	PACKAGE
ULCSA-28.8S	37.3	1.9	1.57	500

MOUNTING HOLE
THICKNESS: T

SPACER SUPPORT

- ◆ MATERIAL: NYLON 66 (UL)
- ◆ FLAME CLASS: 94V-2/94V-0
- ◆ COLOR: NATURAL/BLACK/BLUE
- ◆ UNIT: mm



P.C.B Ø2.35
THICKNESS 1.0

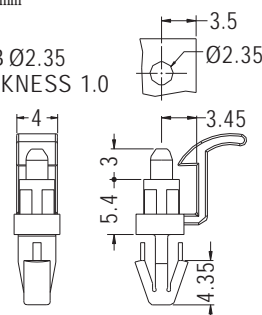

PARTNO	PACKAGE
ULCBA-5	1000

CHASSIS Ø4.0
THICKNESS 2.4



SPACER SUPPORT

NEW



- ◆ MATERIAL: NYLON 66 (UL)
- ◆ FLAME CLASS: 94V-2/94V-0
- ◆ COLOR: NATURAL/BLACK
- ◆ UNIT: mm

P.C.B Ø3.4
THICKNESS 1.2

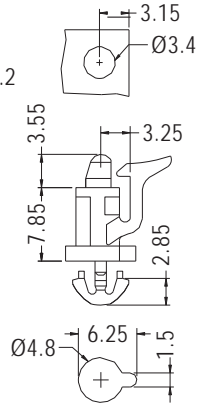

MOUNTING HOLE
THICKNESS 1.6

PART NO	PACKAGE
ULCBA-7.8	1000

1

SPACER SUPPORT

- ◆ MATERIAL: NYLON 66 (UL)
- ◆ FLAME CLASS: 94V-2/94V-0
- ◆ COLOR: NATURAL/WHITE/BLACK
- ◆ UNIT: mm

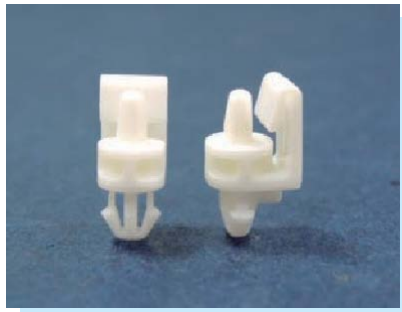

P.C.B Ø2.6
THICKNESS 0.8-1.0

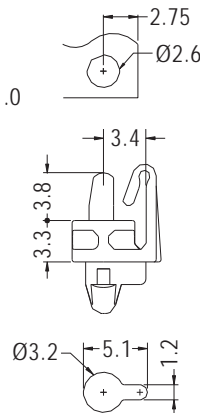
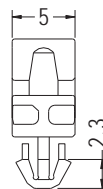

MOUNTING HOLE
THICKNESS 1.4-1.6

PART NO	PACKAGE
LCUE-3.3	1000

SPACER SUPPORT

- ◆ MATERIAL: NYLON 66 (UL)
- ◆ FLAME CLASS: 94V-2/94V-0
- ◆ COLOR: NATURAL/BLACK
- ◆ UNIT: mm



P.C.B Ø4.0
THICKNESS 1.6

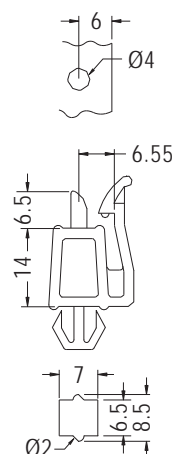
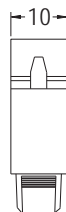

MOUNTING HOLE
THICKNESS 0.8-2.4

PART NO	PACKAGE
KES-15	500



SPACER SUPPORT

- ◆ MATERIAL:NYLON 66 (UL)
- ◆ FLAME CLASS:94V-2/94V-0
- ◆ COLOR:NATURAL/BLACK
- ◆ UNIT:mm

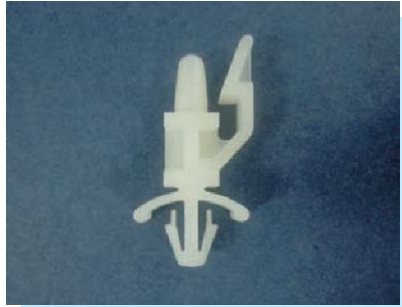

P.C.B Ø4.0
THICKNESS 0.8-1.6

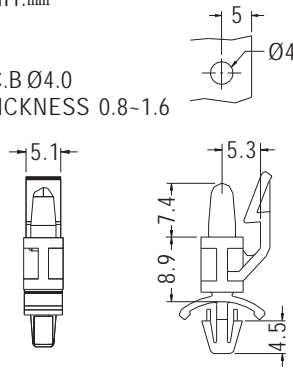

CHASSIS Ø4.0
THICKNESS 0.8-2.0

PARTNO	PACKAGE
ULCE-9	1000

SPACER SUPPORT

- ◆ MATERIAL:NYLON 66 (UL)
- ◆ FLAME CLASS:94V-2/94V-0
- ◆ COLOR:NATURAL/BLACK
- ◆ UNIT:mm

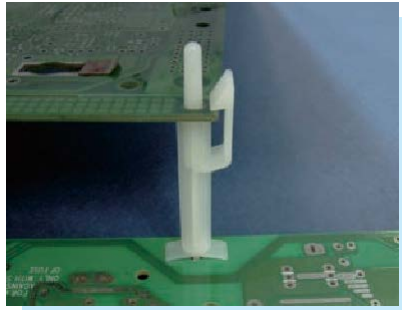

P.C.B Ø4.0
THICKNESS 1.6

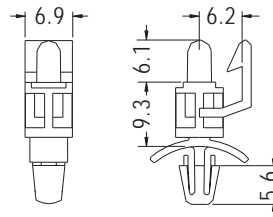

CHASSIS Ø4.8
THICKNESS 1.6-2.2

PART NO	PACKAGE
ULCB-9S	1000

P.C.B Ø4.0
THICKNESS 1.6

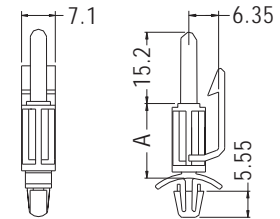

CHASSIS Ø4.8
THICKNESS 1.6

PART NO	A	PACKAGE
ULCB-15	15.9	1000
ULCB-38	38.1	

SPACER SUPPORT

- ◆ MATERIAL:NYLON 66 (UL)
- ◆ FLAME CLASS:94V-2/94V-0
- ◆ COLOR:NATURAL/BLACK
- ◆ UNIT:mm

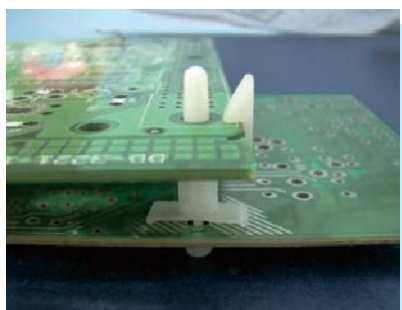

P.C.B Ø4.0
THICKNESS 1.6-1.8

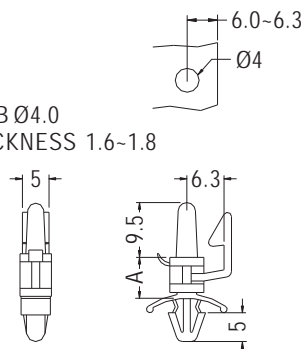

CHASSIS Ø4.8
THICKNESS 0.5-2.0

PART NO	A	PACKAGE
ULCB-6	6.3	1000
ULCB-8	8.0	
ULCB-9	9.5	
ULCB-10	10.0	
ULCB-12	12.7	
ULCB-16	15.9	
ULCB-19.1	19.1	
ULCB-23	23.0	



SPACER SUPPORT



- ◆ MATERIAL: NYLON 66 (UL)
- ◆ FLAME CLASS: 94V-2/94V-0
- ◆ COLOR: NATURAL/BLACK/BLUE
- ◆ UNIT: mm

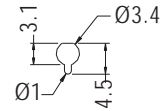
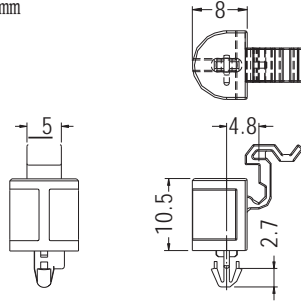

MOUNTING HOLE
CHASSIS THICKNESS 2.4

PART NO	PACKAGE
LCUA-11	1000

SPACER SUPPORT

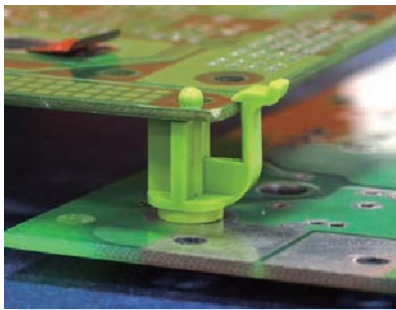

- ◆ MATERIAL: NYLON 66 (UL)
- ◆ FLAME CLASS: 94V-2/94V-0
- ◆ COLOR: NATURAL/BLACK/GREEN
- ◆ UNIT: mm

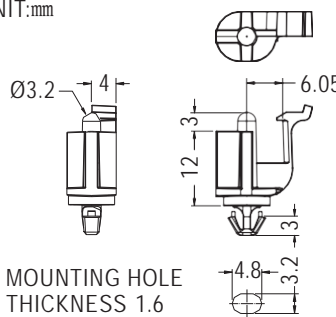

MOUNTING HOLE
THICKNESS 1.6

PART NO	PACKAGE
LCUAC-8L	1000

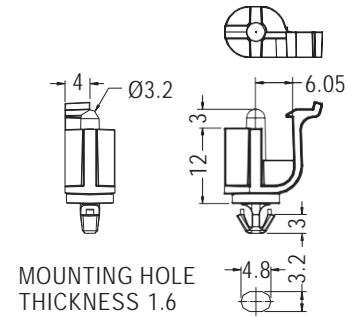

MOUNTING HOLE
THICKNESS 1.6

PART NO	PACKAGE
LCUAC-8R	1000

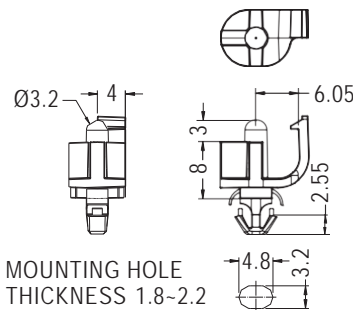

MOUNTING HOLE
THICKNESS 1.8-2.2

PART NO	PACKAGE
LCUAC-9L	1000

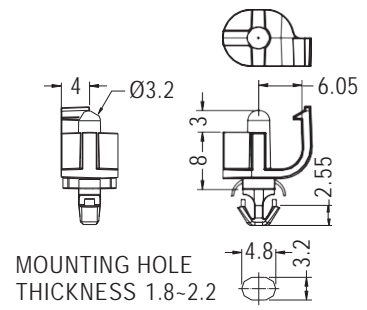

MOUNTING HOLE
THICKNESS 1.8-2.2

PART NO	PACKAGE
LCUAC-9R	1000

SPACER SUPPORT



- ◆ MATERIAL: NYLON 66 (UL)
- ◆ FLAME CLASS: 94V-2/94V-0
- ◆ COLOR: NATURAL/BLACK/GREEN
- ◆ UNIT: mm

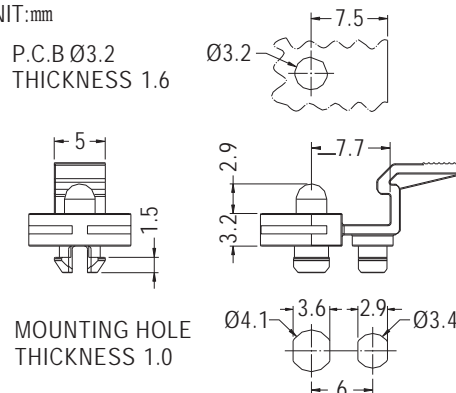

P.C.B Ø3.2
THICKNESS 1.6

MOUNTING HOLE
THICKNESS 1.0

PART NO	PACKAGE
LCUAD-1	1000



SPACER SUPPORT



- ◆ MATERIAL: NYLON 66 (UL)
- ◆ FLAME CLASS: 94V-2/94V-0
- ◆ COLOR: NATURAL/BLACK
- ◆ UNIT: mm

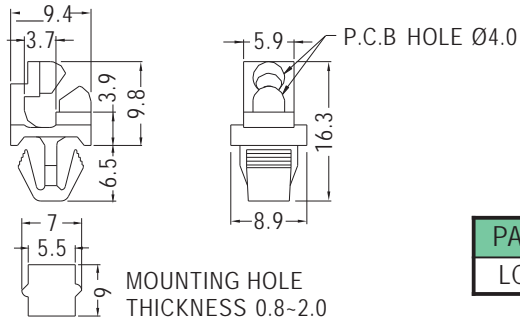

PART NO	PACKAGE
LCMM-4	1000

SPACER SUPPORT

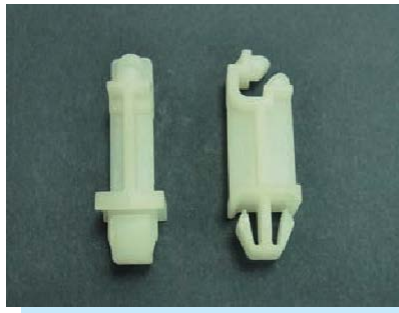

- ◆ MATERIAL: NYLON 66 (UL)
- ◆ FLAME CLASS: 94V-2/94V-0
- ◆ COLOR: NATURAL/BLACK
- ◆ UNIT: mm

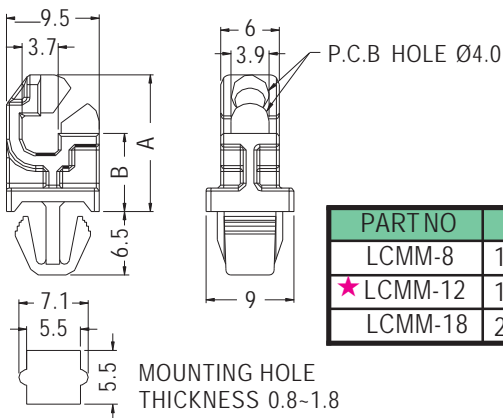

PART NO	A	B	PACKAGE
LCMM-8	14.0	8.0	1000
★ LCMM-12	18.0	12.0	
LCMM-18	24.0	18.0	

SPACER SUPPORT



- ◆ MATERIAL: NYLON 66 (UL)
- ◆ FLAME CLASS: 94V-2/94V-0
- ◆ COLOR: NATURAL/BLACK
- ◆ UNIT: mm

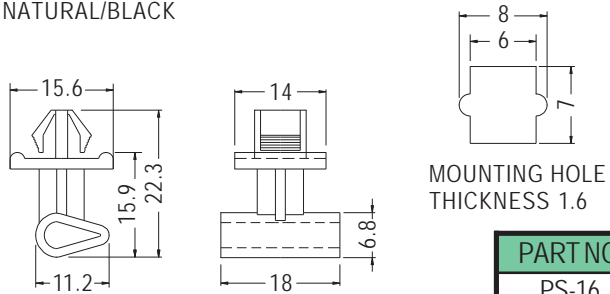

PART NO	PACKAGE
PS-16	500

SPACER SUPPORT

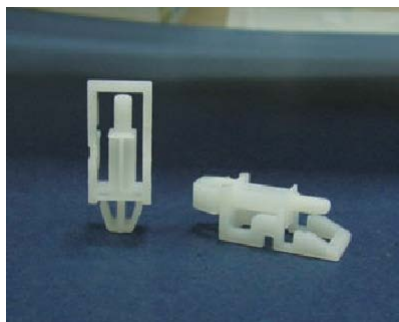

- ◆ MATERIAL: NYLON 66 (UL)
- ◆ FLAME CLASS: 94V-2/94V-0
- ◆ COLOR: NATURAL/BLACK
- ◆ UNIT: mm

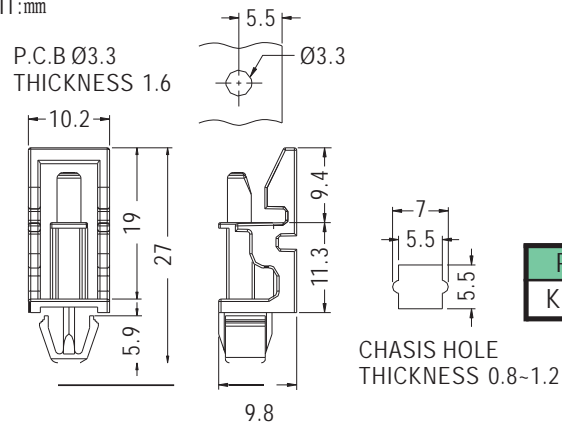

PART NO	PACKAGE
KEMS-11.3	500

SPACER SUPPORT

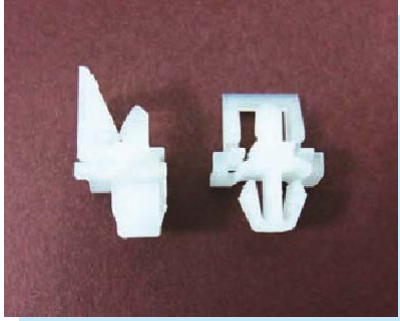

- ◆ MATERIAL: NYLON 66 (UL)
- ◆ FLAME CLASS: 94V-2/94V-0
- ◆ COLOR: NATURAL/BLACK
- ◆ UNIT: mm

P.C.B Ø4.0
THICKNESS 1.6

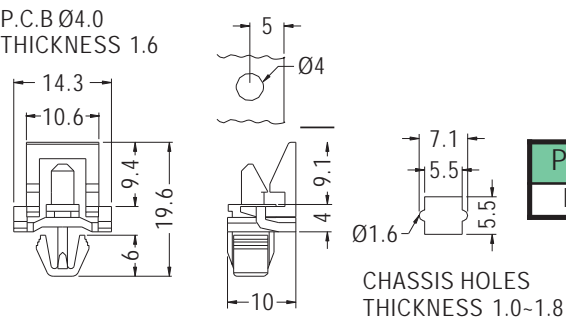

PART NO	PACKAGE
KEML-4	500

SPACER SUPPORT



- ◆ MATERIAL: NYLON 66 (UL)
- ◆ FLAME CLASS: 94V-2/94V-0
- ◆ COLOR: NATURAL/BLACK
- ◆ UNIT: mm

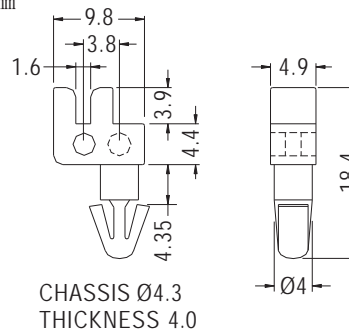

PART NO	PACKAGE
LCU-18	2000

SPACER SUPPORT



- ◆ MATERIAL: PC+ABS (UL)
- ◆ FLAME CLASS: 94V-2/94V-0
- ◆ COLOR: NATURAL
- ◆ UNIT: mm

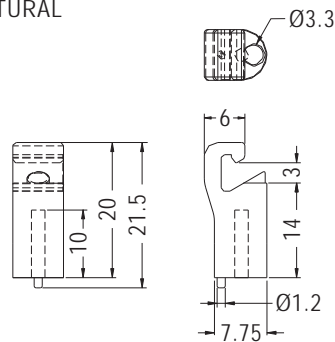

PART NO	PACKAGE
KESS-19	500

SPACER SUPPORT



- ◆ MATERIAL: NYLON 66 (UL)
- ◆ FLAME CLASS: 94V-2/94V-0
- ◆ COLOR: NATURAL/BLACK
- ◆ UNIT: mm

P.C.B Ø4.0
THICKNESS 1.6-1.8

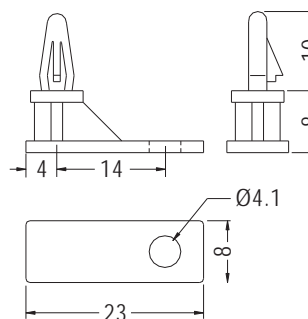

PART NO	PACKAGE
LCBL-8	1000

SPACER SUPPORT



- ◆ MATERIAL: NYLON 66 (UL)
- ◆ FLAME CLASS: 94V-2/94V-0
- ◆ COLOR: NATURAL/BLACK
- ◆ UNIT: mm

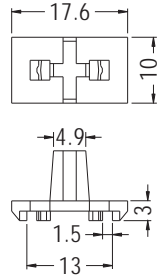

PART NO	PACKAGE
LIH-8	2000

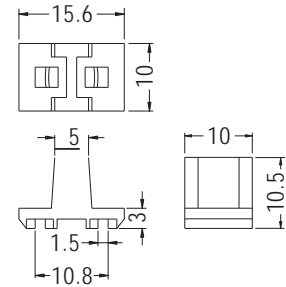

PART NO	PACKAGE
MOU-01	2000

SPACER SUPPORT



- ◆ MATERIAL: NYLON 66 (UL)
- ◆ FLAME CLASS: 94V-2/94V-0
- ◆ COLOR: NATURAL/BLACK
- ◆ UNIT: mm

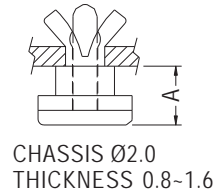
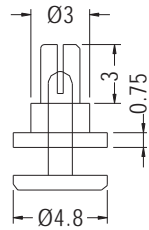

PART NO	A	PACKAGE
SRMA-3	3.0	2000
SRMA-3.5	3.5	
SRMA-4	4.0	
SRMA-5	5.0	
SRMA-9	9.0	

SPACER SUPPORT



- ◆ MATERIAL: NYLON 66 (UL)
- ◆ FLAME CLASS: 94V-2/94V-0
- ◆ COLOR: NATURAL/BLACK
- ◆ UNIT: mm

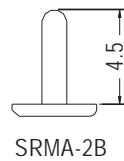
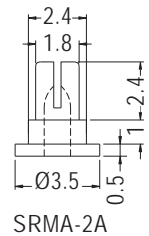

SRMA-2B
CHASSIS Ø1.8
THICKNESS 1.0-1.2

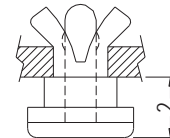

PART NO		PACKAGE
SRMA-2	SRMA-2A	2000
SRMA-2F	SRMA-2B	

SPACERSUPPORT



- ◆ MATERIAL: NYLON 66 (UL)
- ◆ FLAME CLASS: 94V-2/94V-0
- ◆ COLOR: NATURAL/BLACK
- ◆ UNIT: mm

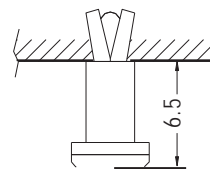
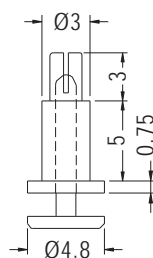

HOLE Ø2.0

PART NO	PACKAGE
SRMA-6	2000



SPACER SUPPORT



- ◆ CLIP MATERIAL:PC (UL)/94V-2
- ◆ PIN MATERIAL:NYLON 66 (UL)/94V-2
- ◆ COLOR:BLACK
- ◆ UNIT:mm

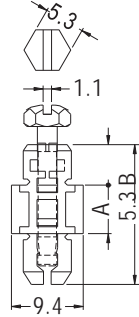

CHASSIS Ø6.4-Ø6.5
THICKNESS 0.8-1.6

PART NO	A	B	PACKAGE
SCMB-6.3	6.35	18.3	1000
SCMB-9.5	9.5	21.45	
SCMB-12.7	12.7	24.65	
SCMB-15.9	15.9	27.85	
SCMB-19.1	19.1	31.05	

1

SPACER



- ◆ MATERIAL:PC (UL)
- ◆ FLAME CLASS:94V-2
- ◆ COLOR:NATURAL/BLACK
- ◆ UNIT:mm

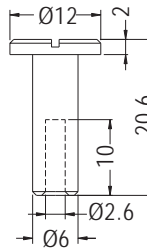

PART NO	PACKAGE
SMHC-1	1000

SUPPORT



- ◆ MATERIAL:NYLON 66 (UL)/94V-0
- ◆ PIN MATERIAL:BRASS
- ◆ COLOR:NATURAL
- ◆ UNIT:mm

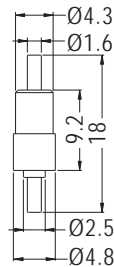

PART NO	PACKAGE
ROFF-10F	1000

SPACER SUPPORT



- ◆ MATERIAL:NYLON 66 (UL)/PC(UL)
- ◆ FLAME CLASS:94V-2/94V-0
- ◆ COLOR:NATURAL/BLACK/TRANSPARENT
- ◆ UNIT:mm

P.C.B Ø4.0
THICKNESS 1.6-1.9

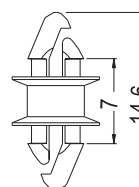

P.C.B Ø4.0
THICKNESS 1.6-1.9

PART NO	PACKAGE
MSPR-3	1000



BRACKET



- ◆ MATERIAL: NYLON 66 (UL)
- ◆ FLAME CLASS: 94V-2/94V-0
- ◆ COLOR: NATURAL/BLACK
- ◆ UNIT: mm

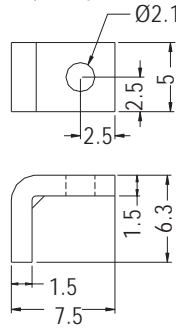

PART NO	PACKAGE
DELT-19	1000

SPACER SUPPORT



- ◆ MATERIAL: NYLON 66 (UL)
- ◆ FLAME CLASS: 94V-2/94V-0
- ◆ COLOR: NATURAL/BLACK
- ◆ UNIT: mm

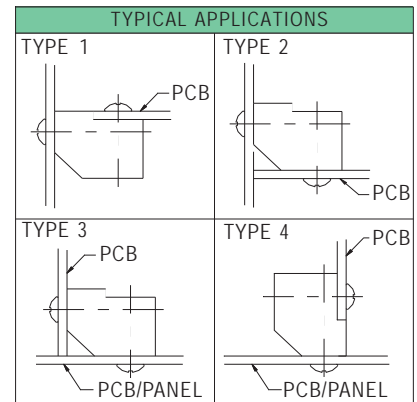
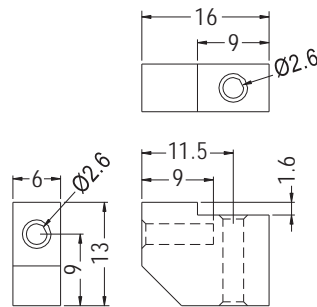

PART NO	PACKAGE
PMB-1	500

SPACER SUPPORT

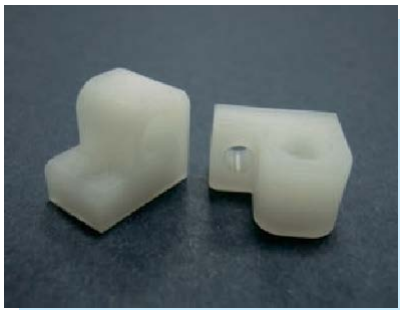

- ◆ MATERIAL: NYLON 66 (UL)
- ◆ FLAME CLASS: 94V-2/94V-0
- ◆ COLOR: NATURAL/BLACK
- ◆ UNIT: mm

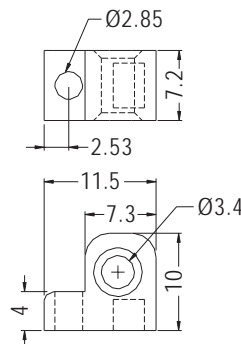

PART NO	PACKAGE
PMB-2	500

SPACER SUPPORT

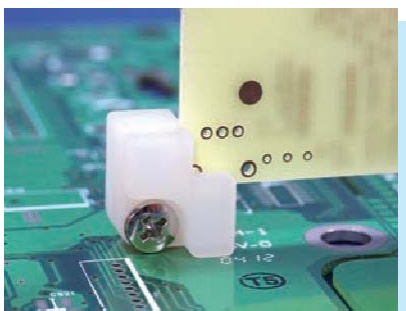

- ◆ MATERIAL: NYLON 66 (UL)
- ◆ FLAME CLASS: 94V-2/94V-0
- ◆ COLOR: NATURAL/BLACK
- ◆ UNIT: mm

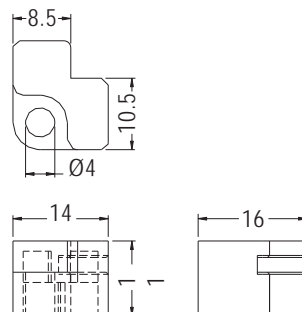

PART NO	PACKAGE
TCEA-1	1000



SPACER SUPPORT



- ◆ MATERIAL: NYLON 66 (UL)
- ◆ FLAME CLASS: 94V-2/94V-0
- ◆ COLOR: NATURAL/BLACK
- ◆ UNIT: mm

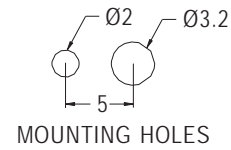
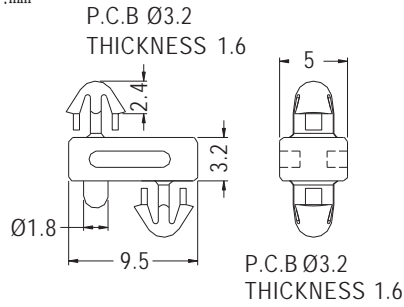

PART NO	PACKAGE
LUCE-1	1000

P.C.B. HINGE



- ◆ MATERIAL: NYLON 66 (UL)
- ◆ FLAME CLASS: 94V-2/94V-0
- ◆ COLOR: NATURAL/BLACK
- ◆ UNIT: mm

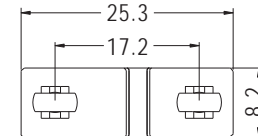
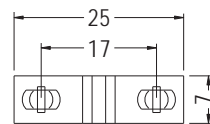
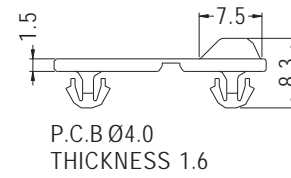
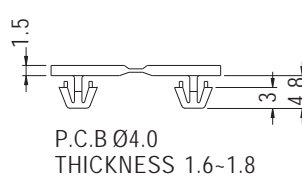

PART NO	PACKAGE
LPZ-1	1000

PART NO	PACKAGE
LPZ-6	1000

P.C.B. HINGE



- ◆ MATERIAL: NYLON 66 (UL)
- ◆ FLAME CLASS: 94V-2/94V-0
- ◆ COLOR: NATURAL/BLACK
- ◆ UNIT: mm

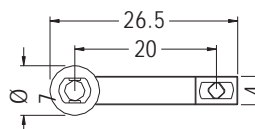
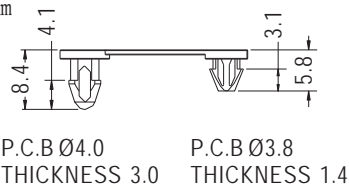

PART NO	PACKAGE
LPZ-2	1000

SPACERSUPPORT



- ◆ MATERIAL: NYLON 66 (UL)
- ◆ FLAME CLASS: 94V-2/94V-0
- ◆ COLOR: NATURAL/BLACK
- ◆ UNIT: mm

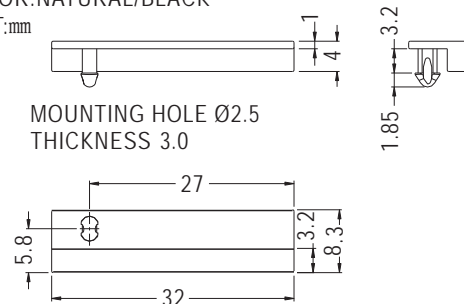

PART NO	PACKAGE
CGLF-32	1000

SPACER SUPPORT



- ◆ MATERIAL: NYLON 66 (UL)
- ◆ FLAME CLASS: 94V-2/94V-0
- ◆ COLOR: NATURAL/BLACK
- ◆ UNIT: mm

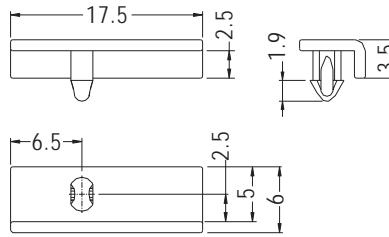

MOUNTING HOLE Ø2.5
THICKNESS 2.5

PART NO	PACKAGE
CGLE-18	1000

SPACER SUPPORT



- ◆ MATERIAL: NYLON 66 (UL)
- ◆ FLAME CLASS: 94V-2/94V-0
- ◆ COLOR: NATURAL/BLACK
- ◆ UNIT: mm

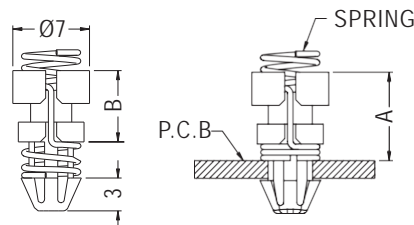

P.C.B Ø4.0
THICKNESS 0.8-1.6

PART NO	A	B	PACKAGE
ALUCA-8	8.0	6.5	1000
ALUCA-9	9.0	7.5	
ALUCA-10	10.0	8.5	
ALUCA-12	12.0	10.5	
ALUCA-14	14.0	12.5	
ALUCA-16	16.0	14.5	

SPACER SUPPORT

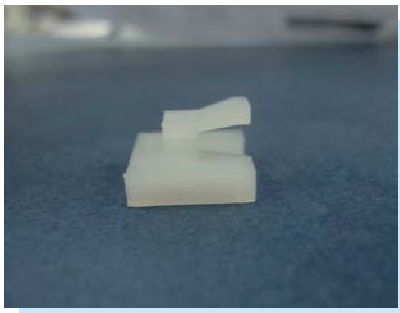

- ◆ MATERIAL: NYLON 66 (UL)
- ◆ FLAME CLASS: 94V-2/94V-0
- ◆ COLOR: NATURAL/BLACK
- ◆ UNIT: mm

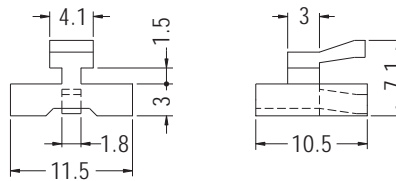

PART NO	PACKAGE
JYCE-1	1000

SPACER SUPPORT



- ◆ MATERIAL: NYLON 66 (UL)
- ◆ FLAME CLASS: 94V-2/94V-0
- ◆ COLOR: NATURAL/BLACK
- ◆ UNIT: mm

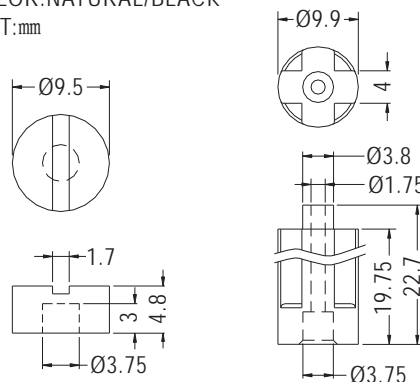

JYCE-2B

JYCE-2A

PART NO	PACKAGE
JYCE-2	500

ROUND SPACER

- ◆ MATERIAL: NYLON 66 (UL)
- ◆ FLAME CLASS: 94V-2/94V-0
- ◆ COLOR: NATURAL/BLACK
- ◆ UNIT: mm

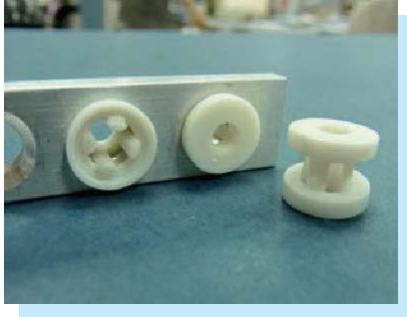

P.C.B Ø7.2
THICKNESS 5.0

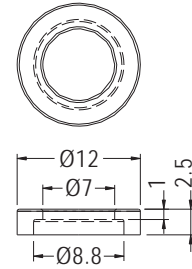
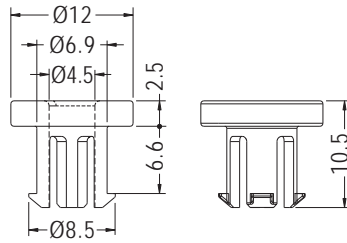

PART NO	PACKAGE
RML-1	1000

PART NO	PACKAGE
RML-25	1000

ROUND SPACER

- ◆ MATERIAL: ABS
- ◆ FLAME CLASS: 94HB
- ◆ COLOR: NATURAL
- ◆ UNIT: mm



- ◆ MATERIAL: NYLON 66 (UL)
- ◆ FLAME CLASS: 94V-2/94V-0
- ◆ COLOR: NATURAL/BLACK
- ◆ UNIT: mm

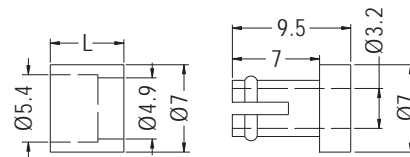

RSS-

RSS-1

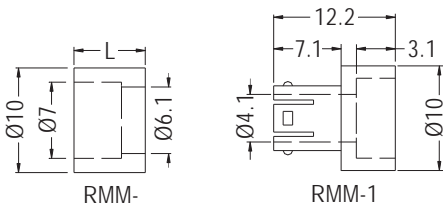

RMM-

RMM-1

PART NO	L	HOLE IN P.C.B	HOLE IN CHASSIS	PACKAGE
RMM-1	RMM-75	7.5	4.0	1000
	RMM-100	10.0	6.5	
	RMM-150	15.0	10.0	

PART NO	L	HOLE IN P.C.B	HOLE IN CHASSIS	PACKAGE
RSS-1	RSS-60	6.0	5.0	1000
	RSS-78	7.8		
	RSS-105	10.5		
	RSS-150	15.0		500
	RSS-180	18.0		
	RSS-200	20.0		
RSS-250	25.0			

- ◆ MATERIAL: ABS
- ◆ FLAME CLASS: 94HB
- ◆ COLOR: NATURAL
- ◆ UNIT: mm

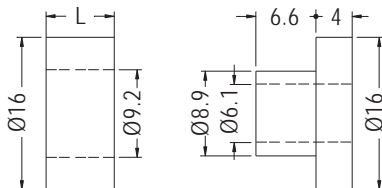

RXL-

RXL-1

PART NO	L	HOLE IN P.C.B	HOLE IN CHASSIS	PACKAGE
RXL-1	RXL-5	5.0	9.0	500
	RXL-7	7.5		
	RXL-10	10.0		

- ◆ MATERIAL: ABS
- ◆ FLAME CLASS: 94HB
- ◆ COLOR: NATURAL
- ◆ UNIT: mm

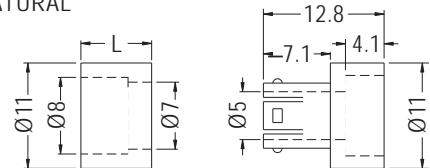

RLL-

RLL-1

PART NO	L	HOLE IN P.C.B	HOLE IN CHASSIS	PACKAGE
RLL-1	RLL-57	5.7	7.5	1000
	RLL-75	7.5		
	RLL-100	10.3		
	RLL-150	15.0		500



ROUND SPACER



- ◆ MATERIAL:PC (UL)
- ◆ FLAME CLASS:94V-0
- ◆ COLOR:NATURAL
- ◆ UNIT:mm

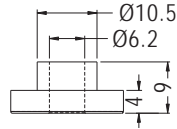
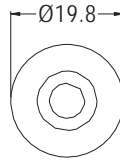

PART NO	PACKAGE
RLA-1	500

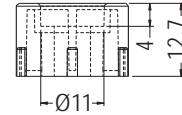
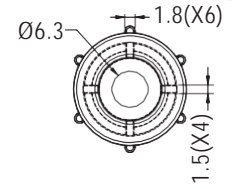

PART NO	PACKAGE
RLA-12.7	500

ROUND SPACER



- ◆ MATERIAL:POM (UL)
- ◆ FLAME CLASS:94HB
- ◆ COLOR:NATURAL/BLACK
- ◆ UNIT:mm

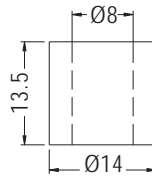

RXS-13.5

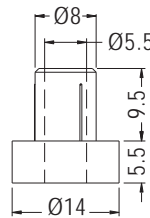

RXS-1

PART NO	PACKAGE
RXS-1	500
RXS-13.5	

SPACER SUPPORT



- ◆ MATERIAL:ABS (UL)
- ◆ FLAME CLASS:94HB
- ◆ COLOR:NATURAL/BLACK
- ◆ UNIT:mm

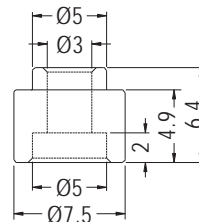

PART NO	PACKAGE
LASK-5	1000

- ◆ MATERIAL:POM(UL)

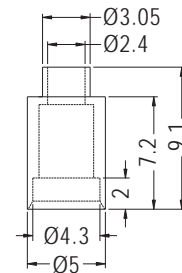

PART NO	PACKAGE
LASK-4	1000

ROUND SPACER



- ◆ MATERIAL:NYLON 66 (UL)
- ◆ FLAME CLASS:94V-2/94V-0
- ◆ COLOR:NATURAL/BLACK
- ◆ UNIT:mm

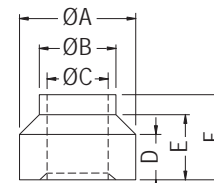
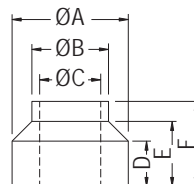

FOR RCSL5-10

PART NO	A	B	C	D	E	F	PACKAGE
RCSL5-10	11.6	7.65	5.4	4.53	8.0	10.0	500
RCSL6-8.5	11.6	7.65	6.1	4.53	6.5	8.5	



SPACER SUPPORT

- ◆ MATERIAL:ABS (UL)/PC+ABS (UL)
- ◆ FLAME CLASS:94HB/94V-0
- ◆ COLOR:NATURAL
- ◆ UNIT:mm

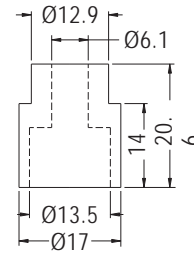
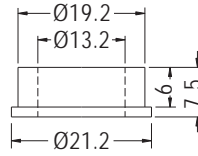

PART NO	PACKAGE
RCXL-1	1000

PART NO	PACKAGE
RCXL-14	1000

ROUND SPACER

- ◆ MATERIAL:NYLON 66 (UL)/PBT (UL)
- ◆ FLAME CLASS:94V-2/94V-0
- ◆ COLOR:NATURAL/BLACK
- ◆ UNIT:mm

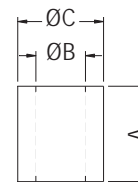
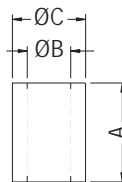

PART NO	A(L)	B (ID)	C (OD)	PACKAGE
2-1.8	1.8	2.2	3.7	2000
2-2	2.0			
2-2.5	2.5			
2-3	3.0			
2-3.2	3.2			
2-4	4.0			
2-4.3	4.3			
2-5	5.0			
2-5.3	5.3			
2-6	6.0			
2-7	7.0			
2-8	8.0			
2-9	9.0			
2-9.5	9.5			
2-10	10.0			
2-11	11.0			
2-12	12.0			
2-13	13.0			
2-14	14.0			
2-15	15.0			
2-16	16.0			

PART NO	A (L)	B (ID)	C (OD)	PACKAGE
2.6-2	2.0	2.6	4.5	2000
2.6-3	3.0			
2.6-4	4.0			
2.6-5	5.0			
2.6-6	6.0			
2.6-7	7.0			
2.6-8	8.0			
2.6-9	9.0			
2.6-10	10.0			
2.6-11	11.0			
2.6-12	12.0			
2.6-13	13.0			
2.6-14	14.0			
2.6-15	15.0			
2.6-16	16.0			



ROUND SPACER

- ◆ MATERIAL: NYLON 66 (UL)
- ◆ FLAME CLASS: 94V-2/94V-0
- ◆ COLOR: NATURAL/BLACK
- ◆ UNIT: mm

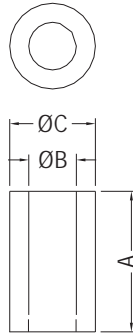

PART NO	A (L)	B (ID)	C (OD)	PACKAGE
3-1.5	1.5	3.2	5.0	2000
3-2	2.0			
3-2.5	2.5			
3-3	3.0			
3-3.3	3.3			
3-3.5	3.5			
3-4	4.0			
3-4.2	4.2			
3-4.5	4.5			
3-5	5.0			
★ 3-5.1	5.05			
3-5.5	5.5			
3-6	6.0			
3-6.35	6.35			
3-7	7.0			
3-7.5	7.5			
3-8	8.0			
3-9	9.0			
3-9.5	9.5			
3-10	10.0			
3-10.5	10.5			
3-11	11.0			
3-12	12.0			

PART NO	A (L)	B (ID)	C (OD)	PACKAGE
3-13	13.0	3.2	5.0	1000
3-13.6	13.6			
3-14	14.0			
3-15	15.0			
3-15.5	15.5			
3-16	16.0			
3-16.5	16.5			
3-16.8	16.8			
3-17	17.0			
3-17.5	17.5			
3-18	18.0			
3-19	19.0			
3-20	20.0			
3-21	21.0			
3-22	22.0			
3-23	23.0			
3-24	24.0			
3-25	25.0			
3-25-6	25.0	3.0	6.0	
3-26	26.0	3.2	5.0	
3-27	27.0			
3-28	28.0			
3-29	29.0			
3-30	30.0			
3-35	35.0			



ROUND SPACER

- ◆ MATERIAL: NYLON 66 (UL)
- ◆ FLAME CLASS: 94V-2/94V-0
- ◆ COLOR: NATURAL/BLACK
- ◆ UNIT: mm

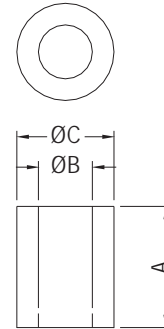
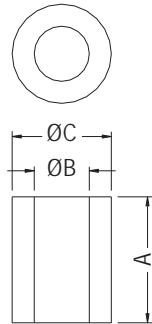

PART NO	A(L)	B (ID)	C (OD)	PACKAGE
3.5-1.6	1.6	3.5	6.3	2000
3.5-2	2.0			
3.5-3	3.0			
3.5-3.5	3.5			
3.5-4	4.0			
3.5-4.5	4.5			
3.5-5	5.0			
3.5-6	6.0			
3.5-7	7.0			
3.5-7.5	7.5			
3.5-8	8.0			
3.5-9	9.0			
3.5-9.5	9.5			
3.5-10	10.0			
3.5-11	11.0			
3.5-12	12.0			
3.5-13	13.0			
3.5-14	14.0			
3.5-15	15.0			
3.5-15.5	15.5			
3.5-16	16.0			
3.5-17	17.0			
3.5-17.7	17.7			
3.5-18	18.0			
3.5-19	19.0			
3.5-20	20.0			
3.5-21	21.0	3.7	6.35	1000
3.5-22	22.0			
3.5-23	23.0			
3.5-24	24.0			
3.5-25	25.0			
3.5-26	26.0			
3.5-27	27.0			
3.5-28	28.0			
3.5-28.5	28.57			
3.5-29	29.0			
3.5-30	30.0	3.7	6.3	
3.5-35	35.0			

PART NO	A(L)	B (ID)	C (OD)	PACKAGE
4-2	2.0	4.2	6.3	2000
4-3	3.0			
4-3.4	3.4			
4-3.5	3.5			
4-4	4.0			
4-4.83	4.83			
4-5	5.0			
4-6	6.0			
4-7	7.0			
4-7.5	7.5			
4-8	8.0			
4-8.5	8.5			
4-9	9.0			
4-9.5	9.5			
4-10	10.0			
4-11	11.0			
4-12	12.0			
4-12.7	12.7			
4-13	13.0			
4-14	14.0			
4-15	15.0			
4-16	16.0			
4-17	17.0			
4-18	18.0			
4-19	19.0			
4-20	20.0	4.2	6.3	1000
4-21	21.0			
4-22	22.0			
4-23	23.0			
4-24	24.0			
4-25	25.0			
4-26	26.0			
4-27	27.0			
4-28	28.0			
4-28.7	28.7			
4-29	29.0			
4-30	30.0			
4-40	40.0			
4-45	45.0			



ROUND SPACER



- ◆ MATERIAL: NYLON 66 (UL)/POM/PE/PC (UL)/ABS (UL)/PPS
- ◆ FLAME CLASS: 94V-2/94V-0/94HB
- ◆ COLOR: NATURAL/BLACK
- ◆ UNIT: mm

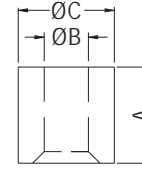
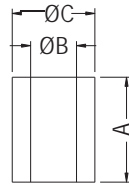

FOR 2.3-5, 2.3-5.5

PART NO	A(L)	B(ID)	C(OD)	PACKAGE	
0.7-1.6	1.6	0.7	2.0	1000	
0.7-3	3.0	0.71	2.2		
1.2-2.5	2.5	1.2	4.0		
1.2-3	3.0		3.2		
1.2-7.6	7.6		4.0		
1.4-3	3.0		1.4		3.5
1.7-11.3	11.3	1.7	3.0		
2.3-1.9	1.9	2.02	3.0		2000
2.05-3.5	3.5	2.05	3.0		1000
2.1-2.1	2.1	2.1	2.4		2000
2.2-2.5	1.5	2.2	2.5		
2.3-5	5.0	2.3	5.0	1000	
2.3-5.5	5.5				
2.4-9.4	9.4	2.4	4.8		
2.5-2.15	2.15	2.5	4.0		
2.5-1655	16.0		5.5		
2.7-2.8	2.84	2.7	6.35		
2.7-6.7	6.71				
3.1-2.2	2.2	3.1	8.0		
3.1-3.5	3.5		5.7		
★ 3.1-4-6	4.0		6.0		
3.1-3.8	3.85	3.15	5.0		
3.1-4	4.0				
3.2-2.5	2.5	3.2	4.2	1000	
3.2-3	3.0		5.8		
3.2-4.45	4.45		6.4		
3-5.8	5.85		5.0		
3.2-6.4	6.4		5.8		
6432-6.4			6.4		
3.2-6.8	6.8		4.5		
★ 3.2-10	10.0		8.0		
3.35-5	5.0		3.35		8.0
★ 3.5-5.5	5.5		3.5		6.3
3.55-10	10.0	3.55	6.0		
3.6-19	19.0	3.6	8.0		
3.7-10	10.0	3.73	6.35		
3.9-5.3	5.3	3.9	8.0		
4.2-8.5	8.5	4.2	10.0		
4.4-6	6.0	4.4	7.43		
4.4-6.4	6.4		9.5		
4.5-3.2	3.18	4.45	6.35		
4.5-2.75	2.75	4.5	6.0		
4.5-19.9	19.9		6.1	250	
4.7-3.5	3.5		4.7	6.0	
4.9-3	3.0	4.9	7.94	1000	
4.9-4.5	4.5				
4.9-11.5	11.5				
4.9-13	13.0				
5-3.5	3.5				5.0
5-6.5L	6.5	9.5			
5-7.9L	7.9	9.5			

PART NO	A(L)	B(ID)	C(OD)	PACKAGE		
5-40	40.0	5.0	9.0	500		
★ 5.1-12.7	12.7	5.1	9.5	1000		
5.2-2.3	2.3	5.2	6.8	1000		
5.2-3	3.0					
5.2-4.1	4.1					
5.2-7.5	7.5		7.6			
5.2-11	11.0					
5.2-13	13.0		6.8			
5.4-122	122.0		5.4		9.53	250
5.5-4	4.0		5.5		15.0	1000
5.55-11.8	11.8		5.55		7.0	
5-5	5.0		5.6		8.6	
5-6	6.0					
5-7.9	7.9					
5-8	8.0					
5-8.8	8.8					
5-11.8	11.8					
5-14	14.0					
5-16.5	16.5					
5-16.7	16.7					
5-17	17.0					
5-20	20.0	5.7	7.7	250		
5.7-12.9	12.9					
5.7-14.1	14.1	6.0	10.0	1000		
6-6	6.0					
6.2-6S	6.0				6.2	10.0
6.2-12	12.0					10.4
6.3-20	20.0	6.3	12.7	250		
★ 6.4-3	3.0	6.4	12.0	1000		
6.5-3	3.0	6.5	9.2			
6-4.2	4.2	6.6	10.6			
6-4.8	4.8		9.1			
6-16	15.7					
6.8-5	5.0	6.8	10.0			
★ 6.9-12.7	12.7	6.9	12.7			
7-5.5	5.5	7.0	13.0			
7-8.7	8.7		10.0			
7.5-8.9	8.9	7.5	10.0			
7.5-29	29.0		11.0	250		
8-16	15.7		8.1	10.7		
★ 8.4-5	5.0	8.4	16.0	1000		
8.5-4.6	4.6	8.5	10.3			
8.5-612	6.0		12.0			
8.5-8	7.9		11.0			
9.1-7.5	7.5		9.1		17.9	
★ 9.25-4	4.0	9.25	12.25			
1012-26	26.0	10.0	12.0		250	
12.8-35	35.0	12.8	22.0		1000	
20.5-9.5	9.5	20.5	25.5			
29-16	16.0	29.5	33.5			



ROUND SPACER WITH ADHESIVE TAPE

- ◆ MATERIAL: NYLON 66 (UL)
- ◆ FLAME CLASS: 94V-2/94V-0
- ◆ COLOR: NATURAL/BLACK
- ◆ UNIT: mm

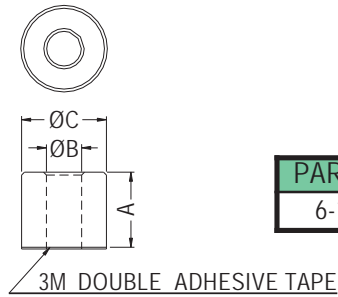

PARTNO	A	B	C	PACKAGE
6-13A	13.0	6.1	14.7	1000

ROUND SPACER

- ◆ MATERIAL: NYLON 66 (UL)
- ◆ FLAME CLASS: 94V-2/94V-0
- ◆ COLOR: NATURAL/BLACK
- ◆ UNIT: mm

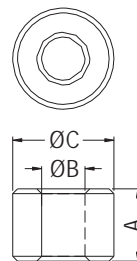

PARTNO	A	B	C	PACKAGE
9-15	15.0	9.0	21.0	1000

SUPPORT

- ◆ MATERIAL: PC (UL)
- ◆ FLAME CLASS: 94V-2/94V-0
- ◆ COLOR: NATURAL
- ◆ UNIT: mm

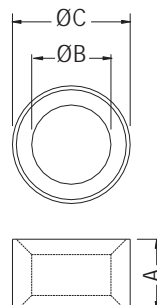

PARTNO	A	B	C	PACKAGE
DELTA-3	5.6	6.2	9.2	1000

ROUND SPACER

- ◆ MATERIAL:NYLON 66 (UL)
- ◆ FLAME CLASS:94V-2/94V-0
- ◆ COLOR:NATURAL/BLACK
- ◆ UNIT:mm

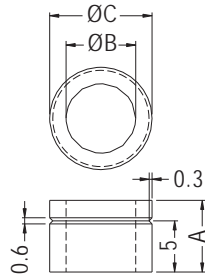

PARTNO	A	B	C	PACKAGE
RR-1	7.0	6.8	10.0	1000

ROUND SPACER

- ◆ MATERIAL:ABS (UL)
- ◆ FLAME CLASS:94HB
- ◆ COLOR:NATURAL
- ◆ UNIT:mm

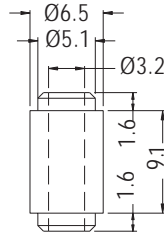

PARTNO	PACKAGE
LUS-9.1	1000

- ◆ MATERIAL:NYLON 66 (UL)
- ◆ FLAME CLASS:94V-2/94V-0
- ◆ COLOR:NATURAL/BLACK
- ◆ UNIT:mm

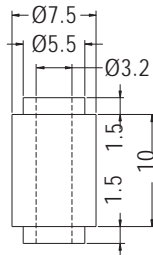

PARTNO	PACKAGE
LUS-10	1000

ROUND SPACER

- ◆ MATERIAL:N6T (UL)
- ◆ FLAME CLASS:94V-0
- ◆ COLOR:BLACK
- ◆ UNIT:mm

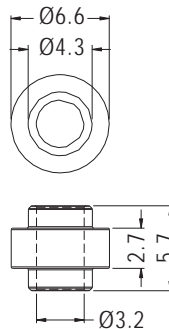

PARTNO	PACKAGE
LUS-2.7	1000



ROUND SPACER

NEW

- ◆ MATERIAL: NYLON 66 (UL)
- ◆ FLAME CLASS: 94V-2/94V-0
- ◆ COLOR: NATURAL/BLACK
- ◆ UNIT: mm

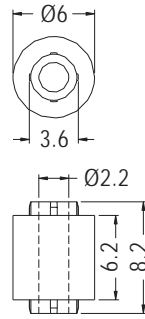

MOUNTING HOLE Ø3.5

PART NO	PACKAGE
LUS2-8.2	1000

1

ROUND SPACER

- ◆ MATERIAL: PBT (UL)
- ◆ FLAME CLASS: 94V-0
- ◆ COLOR: NATURAL/BLACK
- ◆ UNIT: mm

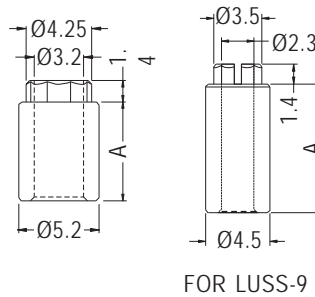

FOR LUSS-9

PART NO	A	PACKAGE
LUSS-6.4	6.4	1000
LUSS-7.1	7.07	
★ LUSS-9	9.0	
LUSS-9.4	9.43	
LUSS-10.1	10.06	

SPACERSUPPORT

- ◆ MATERIAL: NYLON 66 (UL)
- ◆ FLAME CLASS: 94V-2/94V-0
- ◆ COLOR: NATURAL/BLACK
- ◆ UNIT: mm

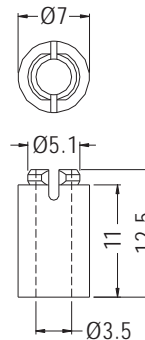

P.C.B Ø5.0
THICKNESS 1.6-1.8

PART NO	PACKAGE
LUSA-11	1000



SPACER SUPPORT

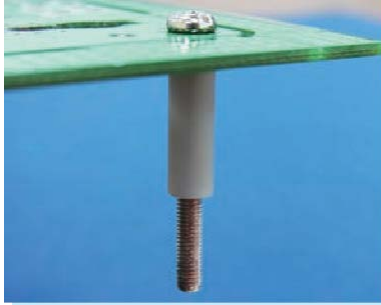

- ◆ MATERIAL: NYLON 66 (UL)
- ◆ FLAME CLASS: 94V-2/94V-0
- ◆ COLOR: NATURAL/BLACK
- ◆ UNIT: mm

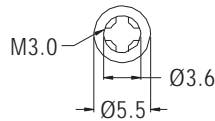

PARTNO	A	PACKAGE
KWH3-2	2.0	2000
KWH3-3	3.0	
KWH3-3.5	3.5	
KWH3-4	4.0	
KWH3-5	5.0	
KWH3-6	6.0	
KWH3-6.3	6.3	
KWH3-7	7.0	
KWH3-8	8.0	
KWH3-9	9.0	
KWH3-9.5	9.5	
KWH3-10	10.0	
KWH3-11	11.0	
KWH3-11.5	11.5	
KWH3-12	12.0	
KWH3-12.7	12.7	
KWH3-13	13.0	
KWH3-14	14.0	

PARTNO	A	PACKAGE
KWH3-15	15.0	2000
KWH3-15.9	15.9	
KWH3-16	16.0	
KWH3-17	17.0	
KWH3-18	18.0	
KWH3-19	19.0	
KWH3-20	20.0	1000
KWH3-21	21.0	
KWH3-22	22.0	
KWH3-23	23.0	
KWH3-24	24.0	
KWH3-25	25.0	
KWH3-25.4	25.4	
KWH3-26	26.0	
KWH3-27	27.0	
KWH3-28	28.0	
KWH3-29	29.0	
KWH3-30	30.0	

PARTNO	A	PACKAGE
KWH3.5-2	2.0	2000
KWH3.5-3	3.0	
KWH3.5-4	4.0	
KWH3.5-5	5.0	
KWH3.5-6	6.0	
KWH3.5-6.3	6.3	
KWH3.5-7	7.0	
KWH3.5-8	8.0	
KWH3.5-9	9.0	
KWH3.5-10	10.0	
KWH3.5-11	11.0	
KWH3.5-12	12.0	
KWH3.5-12.7	12.7	
KWH3.5-13	13.0	
KWH3.5-14	14.0	
KWH3.5-15	15.0	

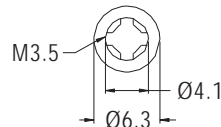
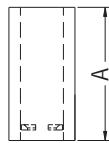

PARTNO	A	PACKAGE
KWH3.5-15.9	15.9	2000
KWH3.5-16	16.0	
KWH3.5-17	17.0	
KWH3.5-18	18.0	
KWH3.5-19	19.0	
KWH3.5-20	20.0	
KWH3.5-21	21.0	1000
KWH3.5-22	22.0	
KWH3.5-23	23.0	
KWH3.5-24	24.0	
KWH3.5-25	25.0	
KWH3.5-25.4	25.4	
KWH3.5-26	26.0	
KWH3.5-27	27.0	
KWH3.5-28	28.0	
KWH3.5-29	29.0	
KWH3.5-30	30.0	

PARTNO	A	PACKAGE
KWH4-2	2.0	2000
KWH4-3	3.0	
KWH4-4	4.0	
KWH4-5	5.0	
KWH4-6	6.0	
KWH4-6.3	6.3	
KWH4-7	7.0	
KWH4-8	8.0	
KWH4-9	9.0	
KWH4-10	10.0	
KWH4-11	11.0	
KWH4-12	12.0	
KWH4-12.7	12.7	
KWH4-13	13.0	
KWH4-14	14.0	
KWH4-15	15.0	

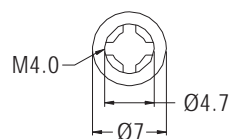
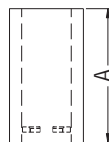

PARTNO	A	PACKAGE
KWH4-15.9	15.9	2000
KWH4-16	16.0	
KWH4-17	17.0	
KWH4-18	18.0	
KWH4-19	19.0	
KWH4-20	20.0	
KWH4-21	21.0	1000
KWH4-22	22.0	
KWH4-23	23.0	
KWH4-24	24.0	
KWH4-25	25.0	
KWH4-25.4	25.4	
KWH4-26	26.0	
KWH4-27	27.0	
KWH4-28	28.0	
KWH4-29	29.0	
KWH4-30	30.0	



SPACER SUPPORT

- ◆ MATERIAL: NYLON 66 (UL)
- ◆ FLAME CLASS: 94V-2/94V-0
- ◆ COLOR: NATURAL/BLACK
- ◆ UNIT: mm

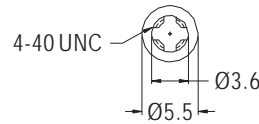
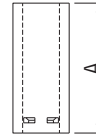

PARTNO	A	PACKAGE
KWH440-2	2.0	2000
KWH440-3	3.0	
KWH440-4	4.0	
KWH440-5	5.0	
KWH440-6	6.0	
KWH440-6.3	6.3	
KWH440-7	7.0	
KWH440-8	8.0	
KWH440-9	9.0	
KWH440-9.5	9.5	
KWH440-10	10.0	
KWH440-11	11.0	
KWH440-12	12.0	
KWH440-12.7	12.7	
KWH440-13	13.0	
KWH440-14	14.0	
KWH440-15	15.0	

PARTNO	A	PACKAGE
KWH440-15.9	15.9	2000
KWH440-16	16.0	
KWH440-17	17.0	
KWH440-18	18.0	
KWH440-19	19.0	
KWH440-20	20.0	1000
KWH440-21	21.0	
KWH440-22	22.0	
KWH440-23	23.0	
KWH440-24	24.0	
KWH440-25	25.0	
KWH440-25.4	25.4	
KWH440-26	26.0	
KWH440-27	27.0	
KWH440-28	28.0	
KWH440-29	29.0	
KWH440-30	30.0	

THREADED SPACER

- ◆ MATERIAL: NYLON 66 (UL)
- ◆ FLAME CLASS: 94V-2/94V-0
- ◆ COLOR: NATURAL/BLACK
- ◆ UNIT: mm

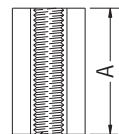
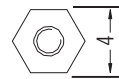

M2X0.4P

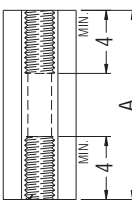

M2X0.4P

PARTNO	A	PACKAGE
HPS2-4	4.0	1000
HPS2-4.5	4.5	
HPS2-5	5.0	
HPS2-6	6.0	
HPS2-7	7.0	
HPS2-8	8.0	
HPS2-9	9.0	
HPS2-10	10.0	
HPS2-11	11.0	
HPS2-12	12.0	
HPS2-12.7	12.7	

PARTNO	A	PACKAGE
HPS2-13	13.0	1000
HPS2-14	14.0	
HPS2-15	15.0	
HPS2-16	16.0	
HPS2-17	17.0	
HPS2-18	18.0	
HPS2-19	19.0	
HPS2-20	20.0	
HPS2-21	21.0	
HPS2-22	22.0	
HPS2-23	23.0	
HPS2-24	24.0	
HPS2-25	25.0	



THREADED SPACER

- ◆ MATERIAL: NYLON 66 (UL)
- ◆ FLAME CLASS: 94V-2/94V-0
- ◆ COLOR: NATURAL/BLACK
- ◆ UNIT: mm

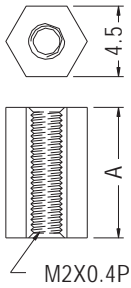

PARTNO	A	PACKAGE
HP2-4	4.0	1000
HP2-5	5.0	
HP2-6	6.0	
HP2-7	7.0	
HP2-8	8.0	
HP2-9	9.0	
HP2-10	10.0	
HP2-11	11.0	
HP2-12	12.0	

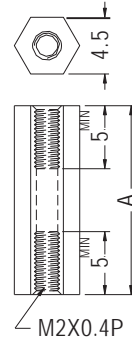

PARTNO	A	PACKAGE
HP2-13	13.0	1000
HP2-14	14.0	
HP2-15	15.0	
HP2-16	16.0	
HP2-17	17.0	
HP2-18	18.0	
HP2-18.8	18.8	
HP2-19	19.0	
HP2-20	20.0	
HP2-21	21.0	
HP2-22	22.0	
HP2-23	23.0	
HP2-24	24.0	
HP2-25	25.0	
HP2-26	26.0	
HP2-27	27.0	
HP2-28	28.0	

THREADED SPACER

- ◆ MATERIAL: NYLON 66 (UL)
- ◆ FLAME CLASS: 94V-2/94V-0
- ◆ COLOR: NATURAL/BLACK
- ◆ UNIT: mm

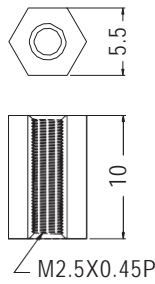
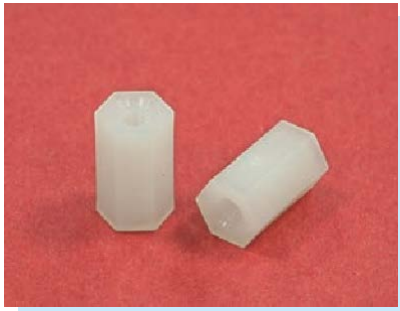

PARTNO	PACKAGE
HP2.5-10	1000

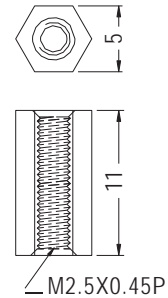

PARTNO	PACKAGE
★ HPS2.5-11	1000

THREADED SPACER

- ◆ MATERIAL: NYLON 66 (UL)
- ◆ FLAME CLASS: 94V-2/94V-0
- ◆ COLOR: NATURAL/BLACK
- ◆ UNIT: mm

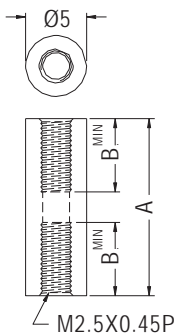

PARTNO	A	B	PACKAGE
HPP25-14.5	14.5	6.0	1000
HPP25-20	20.0	9.0	



THREADED SPACER

- ◆ MATERIAL: NYLON 66 (UL)
- ◆ FLAME CLASS: 94V-2/94V-0
- ◆ COLOR: NATURAL/BLACK
- ◆ UNIT: mm

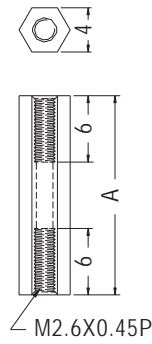

PART NO	A	PACKAGE
HPS2.6-18	18.0	1000
HPS2.6-19	19.0	

THREADED SPACER

- ◆ MATERIAL: NYLON 66 (UL)
- ◆ FLAME CLASS: 94V-2/94V-0
- ◆ COLOR: NATURAL/BLACK
- ◆ UNIT: mm

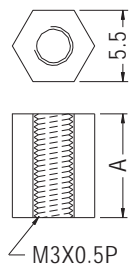
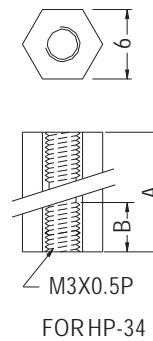
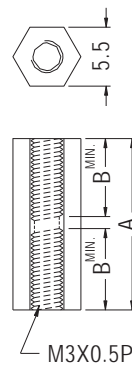

PART NO	A	PACKAGE
HP-4	4.0	1000
HP-5	5.0	
HP-6	6.0	
HP-6.3	6.35	
HP-7	7.0	
HP-8	8.0	
HP-8.5	8.5	
HP-9	9.0	
HP-9.5	9.5	
HP-10	10.0	
HP-10.5	10.5	
HP-11	11.0	
HP-12A	12.0	
HP-12	12.7	

PART NO	A	B	PACKAGE
HP-13.5	13.5	6.0	1000
HP-14	14.0		
HP-14.5	14.5		
HP-15	15.0		
HP-15.5	15.5		
HP-16	16.0		
HP-16.5	16.5		
HP-17	17.0		
HP-18	18.0		
HP-19	19.0		
HP-20	20.0		
HP-21.5	21.5		
HP-22	22.0		
HP-24	24.0		
HP-25	25.0		
HP-26	26.0		
HP-27	27.0		

PART NO	A	B	PACKAGE
HP-28.6	28.6	6.0	1000
HP-30	30.0		
HP-30.8	30.8		
HP-32	32.0		
HP-34	34.0	8.0	500
HP-35	35.0	6.0	
★ HP-37	37.0	8.0	
HP-38	38.0	6.0	
HP-40	40.0		
HP-42	42.0		
HP-45	45.0		
HP-47	47.0		
HP-49	49.0		
HP-52	52.0	8.0	
HP-54	54.0		
HP-55.5	55.5		
★ HP-60.2	60.2		
HP-76.7	76.7	8.5	



THREADED SPACER

- ◆ MATERIAL: NYLON 66 (UL)
- ◆ FLAME CLASS: 94V-2/94V-0
- ◆ COLOR: NATURAL/BLACK
- ◆ UNIT: mm

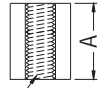
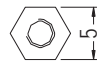

M3X0.5P

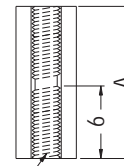

M3X0.5P

PART NO	A	PACKAGE
HPS-6	6.0	1000
HPS-8	8.0	
HPS-10	10.0	
HPS-12	12.0	

PART NO	A	PACKAGE
HPS-15	15.0	1000
HPS-18	18.0	
HPS-20	20.0	
HPS-25	25.0	

THREADED SPACER

- ◆ MATERIAL: NYLON 66 (UL)
- ◆ FLAME CLASS: 94V-2/94V-0
- ◆ COLOR: NATURAL/BLACK
- ◆ UNIT: mm

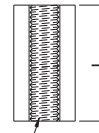

M3X0.5P

PART NO	L	PACKAGE
HPH-10	10.0	2000
HPH-12	12.0	
HPH-15	15.0	

THREADED SPACER

- ◆ MATERIAL: NYLON 66 (UL)
- ◆ FLAME CLASS: 94V-2/94V-0
- ◆ COLOR: NATURAL/BLACK
- ◆ UNIT: mm

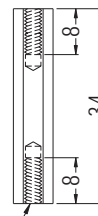

M3X0.5P

PART NO	PACKAGE
HPH-34	1000

THREADED SPACER

- ◆ MATERIAL: NYLON 66 (UL)
- ◆ FLAME CLASS: 94V-2/94V-0
- ◆ COLOR: NATURAL/BLACK
- ◆ UNIT: mm

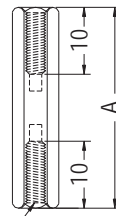

M3X0.5P

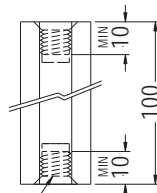

M3X0.5P

PART NO	A	PACKAGE
HPL-30	30.0	500
HPL-40	40.0	

PART NO	PACKAGE
HPL-100	500



THREADED SPACER



- ◆ MATERIAL: NYLON 66 (UL)
- ◆ FLAME CLASS: 94V-2/94V-0
- ◆ COLOR: NATURAL/BLACK/WHITE
- ◆ UNIT: mm

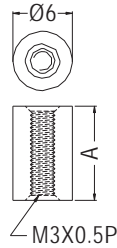

PART NO	A	PACKAGE
HPP3-9	9.0	1000
HPP3-9.5	9.5	

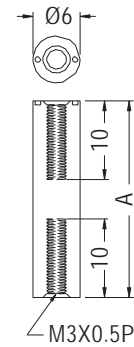

PART NO	A	PACKAGE
★ HPP3-25	25.0	1000

THREADED SPACER



- ◆ MATERIAL: NYLON 66 (UL)
- ◆ FLAME CLASS: 94V-2/94V-0
- ◆ COLOR: NATURAL/BLACK
- ◆ UNIT: mm

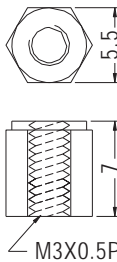

PART NO	PACKAGE
HPR3-7	1000

THREADED SPACER



- ◆ MATERIAL: NYLON 66 (UL)
- ◆ FLAME CLASS: 94V-2/94V-0
- ◆ COLOR: NATURAL/BLACK
- ◆ UNIT: mm

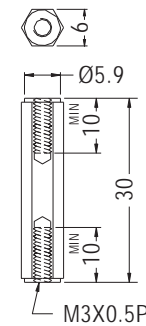

PART NO	PACKAGE
HPR3-30	1000

THREADED SPACER



- ◆ MATERIAL: NYLON 66 (UL)
- ◆ FLAME CLASS: 94V-2/94V-0
- ◆ COLOR: NATURAL/BLACK
- ◆ UNIT: mm

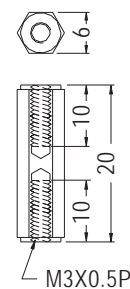

PART NO	PACKAGE
HPR-20	1000



THREADED SPACER



- ◆ MATERIAL: NYLON 66 (UL)
- ◆ FLAME CLASS: 94V-2/94V-0
- ◆ COLOR: NATURAL/BLACK
- ◆ UNIT: mm

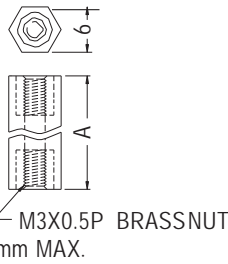

PART NO	A	PACKAGE
HPC-11.9	11.9	1000
HPC-15	15.0	

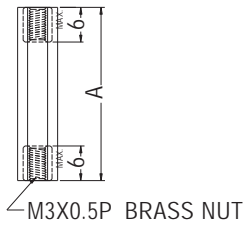

PART NO	A	PACKAGE
HPC-19	19.0	1000
HPC-30	30.0	
HPC-45	45.0	

THREADED SPACER



- ◆ MATERIAL: NYLON 66 (UL)
- ◆ FLAME CLASS: 94V-2/94V-0
- ◆ COLOR: NATURAL/BLACK
- ◆ UNIT: mm

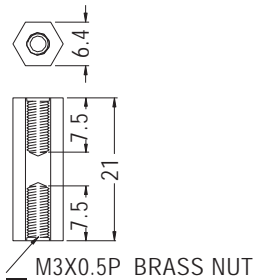

PART NO	PACKAGE
HPCA-21	1000

THREADED SPACER

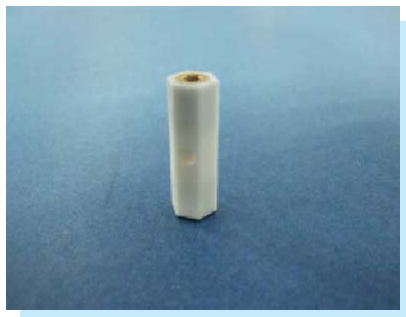

- ◆ MATERIAL: NYLON 66 (UL)
- ◆ FLAME CLASS: 94V-2/94V-0
- ◆ COLOR: NATURAL/BLACK
- ◆ UNIT: mm

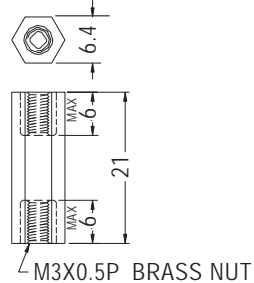

PART NO	PACKAGE
HPC-21	1000

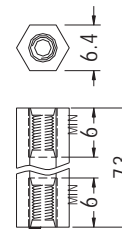

PART NO	PACKAGE
HPC-73	1000

THREADED SPACER



- ◆ MATERIAL: NYLON 66 (UL)
- ◆ FLAME CLASS: 94V-2/94V-0
- ◆ COLOR: NATURAL/BLACK
- ◆ UNIT: mm

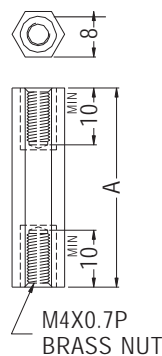

PART NO	A	PACKAGE
HPC4-35	35.0	1000
HPC4-40	40.0	

THREADED SPACER



- ◆ MATERIAL: NYLON 66 (UL)
- ◆ FLAME CLASS: 94V-2/94V-0
- ◆ COLOR: NATURAL/BLACK
- ◆ UNIT: mm

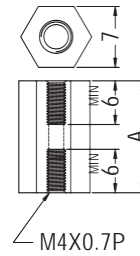
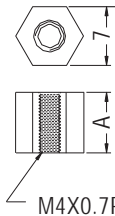

PARTNO	A	PACKAGE
HP4-6	6.0	1000
HP4-7	7.0	
HP4-8	8.0	
HP4-9	9.0	
HP4-10	10.0	
HP4-11	11.0	
HP4-12	12.0	
HP4-12.7	12.7	

PARTNO	A	PACKAGE
HP4-14	14.0	1000
HP4-16	16.0	
HP4-20	20.0	
HP4-25	25.0	
HP4-26	26.0	
HP4-30	30.0	
HP4-35	35.0	
HP4-40	40.0	
HP4-45	45.5	

THREADED SPACER

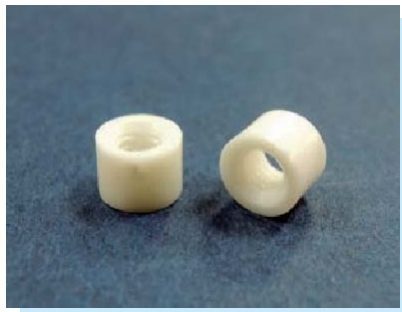

- ◆ MATERIAL: NYLON 66 (UL)
- ◆ FLAME CLASS: 94V-2/94V-0
- ◆ COLOR: NATURAL/WHITE/BLACK
- ◆ UNIT: mm

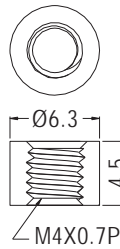

PARTNO	PACKAGE
HPP4-4.5	1000

THREADED SPACER



- ◆ MATERIAL: NYLON 66 (UL)
- ◆ FLAME CLASS: 94V-2/94V-0
- ◆ COLOR: NATURAL/BLACK
- ◆ UNIT: mm

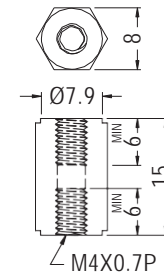
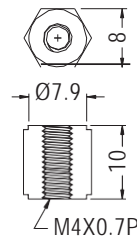

PARTNO	PACKAGE
HPR4-10	1000

PARTNO	PACKAGE
HPR4-15	1000

THREADED SPACER



- ◆ MATERIAL: NYLON 66 (UL)
- ◆ FLAME CLASS: 94V-2/94V-0
- ◆ COLOR: NATURAL/BLACK
- ◆ UNIT: mm

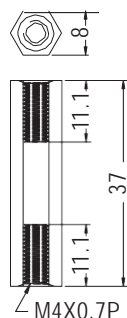

PARTNO	PACKAGE
HPL4-37	1000



THREADED SPACER



- ◆ MATERIAL: NYLON 66 (UL)
- ◆ FLAME CLASS: 94V-2/94V-0
- ◆ COLOR: NATURAL/BLACK
- ◆ UNIT: mm

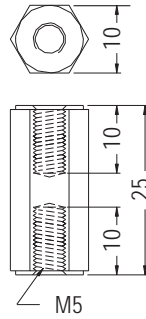

PART NO	PACKAGE
HPR5-25	1000

1

THREADED SPACER



- ◆ MATERIAL: NYLON 66 (UL)
- ◆ FLAME CLASS: 94V-2/94V-0
- ◆ COLOR: NATURAL/BLACK
- ◆ UNIT: mm

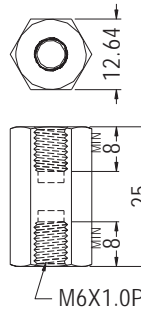

PART NO	PACKAGE
HP6-25	500

THREADED SPACER



- ◆ MATERIAL: PC (UL)
- ◆ FLAME CLASS: 94V-2
- ◆ COLOR: BLACK
- ◆ UNIT: mm

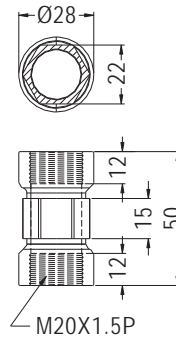

PART NO	PACKAGE
HP2050	1000

THREADED SPACER



- ◆ MATERIAL: NYLON 66 (UL)
- ◆ FLAME CLASS: 94V-2/94V-0
- ◆ COLOR: NATURAL/BLACK
- ◆ UNIT: mm

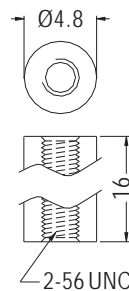

PART NO	PACKAGE
HP256-16	1000



THREADED SPACER



- ◆ MATERIAL: NYLON 66 (UL)
- ◆ FLAME CLASS: 94V-2/94V-0
- ◆ COLOR: NATURAL/BLACK
- ◆ UNIT: mm

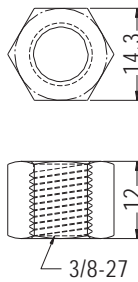

PART NO	PACKAGE
M-3/8-27	1000

THREADED SPACER



- ◆ MATERIAL: NYLON 66 (UL)
- ◆ FLAME CLASS: 94V-2/94V-0
- ◆ COLOR: NATURAL/BLACK
- ◆ UNIT: mm

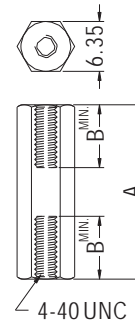
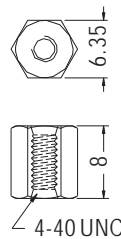

PART NO	PACKAGE
★ HP44L-8	1000

PART NO	A	B	PACKAGE
HP44L-22	22.2	9.0	1000
HP44L-23.8	23.8	6.4	
HP44L-25.4	25.4	9.0	
HP44L-28.6	28.6	6.4	

THREADED SPACER



- ◆ MATERIAL: NYLON 66 (UL)
- ◆ FLAME CLASS: 94V-2/94V-0
- ◆ COLOR: NATURAL/BLACK
- ◆ UNIT: mm

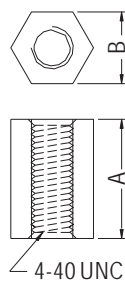

PART NO	A	B	PACKAGE
★ HP440-9.5	9.5	4.8	1000
HP440-7.9S	7.9	4.75	
HP440-15.9S	15.88	4.75	

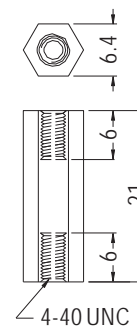
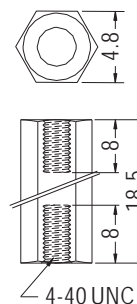

PART NO	PACKAGE
HP440-18	1000

PART NO	PACKAGE
HPC44-21	1000



THREADED SPACER



- ◆ MATERIAL: NYLON 66 (UL)
- ◆ FLAME CLASS: 94V-2/94V-0
- ◆ COLOR: NATURAL/BLACK
- ◆ UNIT: mm

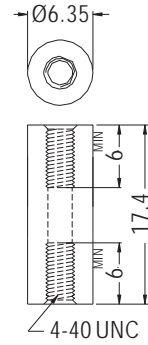
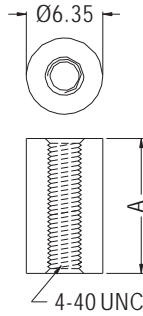

PART NO	A	PACKAGE
HPP440-6.35	6.35	1000
HPP440-11.2	11.2	

PART NO	PACKAGE
HPP440-17.4	1000

THREADED SPACER



- ◆ MATERIAL: NYLON 66 (UL)
- ◆ FLAME CLASS: 94V-2/94V-0
- ◆ COLOR: NATURAL/BLACK
- ◆ UNIT: mm

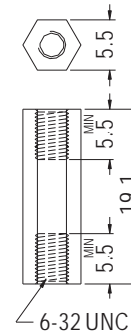
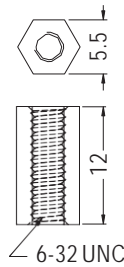

PART NO	PACKAGE
HPS632-12	1000

PART NO	PACKAGE
HPS632-19.1	1000

THREADED SPACER

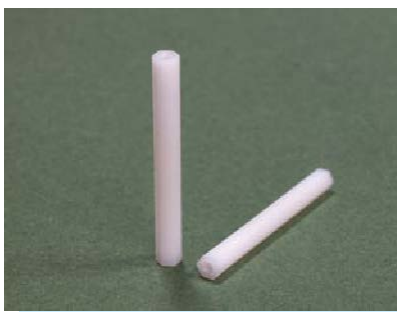

- ◆ MATERIAL: NYLON 66 (UL)
- ◆ FLAME CLASS: 94V-2/94V-0
- ◆ COLOR: NATURAL/BLACK
- ◆ UNIT: mm

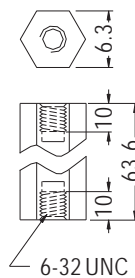

PART NO	PACKAGE
HP632-64	250

THREADED

SPACER



- ◆ MATERIAL: NYLON 66 (UL)
- ◆ FLAME CLASS: 94V-2/94V-0
- ◆ COLOR: NATURAL/BLACK
- ◆ UNIT: mm

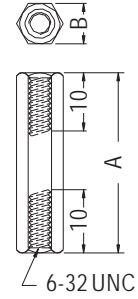
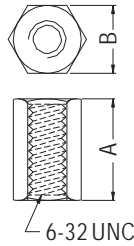

PART NO	A	B	PACKAGE
HP632-9.5	9.5	6.35	1000
HP632-12.7	12.7	6.35	
HP632-25.4	25.4	6.4	

PART NO	A	B	PACKAGE
HP632-28.5	28.5	6.35	1000
HP632-31.8	31.8	6.35	
HP632-38.1	38.1	6.35	

THREADED SPACER



- ◆ MATERIAL: NYLON 66 (UL)
- ◆ FLAME CLASS: 94V-2/94V-0
- ◆ COLOR: NATURAL/BLACK
- ◆ UNIT: mm

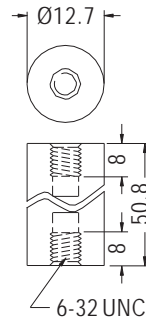
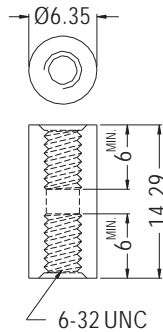

PART NO	PACKAGE
HPP632-14	1000

PART NO	PACKAGE
HPP632-51	200

THREADED SPACER



- ◆ MATERIAL: POM (UL)
- ◆ FLAME CLASS: 94HB
- ◆ COLOR: NATURAL
- ◆ UNIT: mm

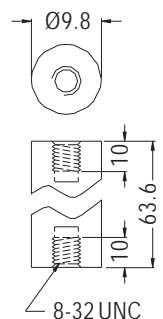

PART NO	PACKAGE
HPP10-64	250



THREADED SPACER

- ◆ MATERIAL: NYLON 66 (UL)
- ◆ FLAME CLASS: 94V-2/94V-0
- ◆ COLOR: NATURAL/BLACK
- ◆ UNIT: mm

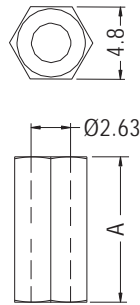

PART NO	A	PACKAGE
HP48-20	20.0	1000
HP48-32	32.0	

THREADED SPACER

- ◆ MATERIAL: NYLON 66 (UL)
- ◆ FLAME CLASS: 94V-2/94V-0
- ◆ COLOR: NATURAL/BLACK
- ◆ UNIT: mm

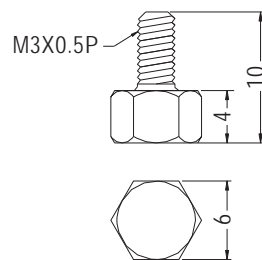
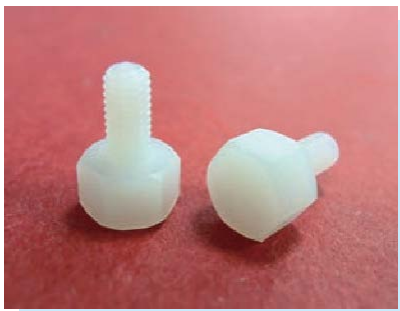

PART NO	PACKAGE
TPA-4	1000

THREADED SPACER

- ◆ MATERIAL: NYLON 66 (UL)
- ◆ FLAME CLASS: 94V-2/94V-0
- ◆ COLOR: NATURAL/BLACK
- ◆ UNIT: mm

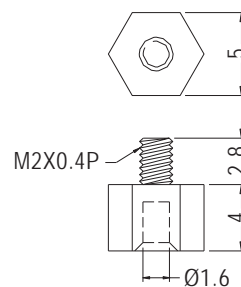

PART NO	PACKAGE
TP2L-4	1000

THREADED SPACER



- ◆ MATERIAL: NYLON 66 (UL)
- ◆ FLAME CLASS: 94V-2/94V-0
- ◆ COLOR: NATURAL/BLACK
- ◆ UNIT: mm

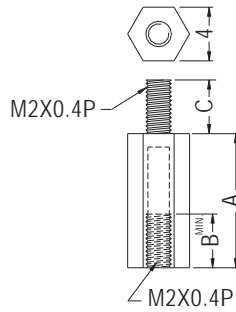

PARTNO	A	B	C	PACKAGE
TP2-5	5.0	3.0	5.0	1000
TP2-5.5	5.5	3.0		
TP2-6	6.0	4.0		
TP2-6.5	6.5	4.0		
TP2-7	7.0	4.0		
TP2-8	8.0	5.0		
TP2-10	10.0	5.0		
TP2-14	14.0	5.0		
TP2-15	15.0	5.0		
TP2-21	21.0	5.0		
TP2-28	28.0	5.0		

PARTNO	A	B	C	PACKAGE
TP2-5S	5.0	3.0	4.0	1000
TP2-6.5S	6.5	4.0		
TP2-8S	8.0	4.0		
TP2-10S	10.0	4.0		
TP2-15S	15.0	4.0		

THREADED SPACER



- ◆ MATERIAL: NYLON 66 (UL)
- ◆ FLAME CLASS: 94V-2/94V-0
- ◆ COLOR: NATURAL/BLACK
- ◆ UNIT: mm

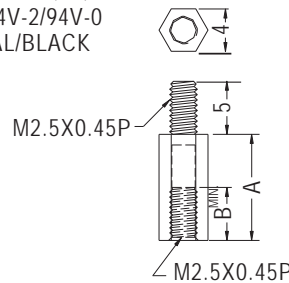

PARTNO	A	B	PACKAGE
TP2.5-5	5.0	3.0	1000
TP2.5-6	6.0	4.0	
TP2.5-7	7.0	5.0	
TP2.5-8	8.0	5.0	
TP2.5-9	9.0	5.0	
TP2.5-10	10.0	5.0	
TP2.5-11	11.0	5.0	
TP2.5-12	12.0	5.0	
TP2.5-13	13.0	5.0	
TP2.5-14	14.0	5.0	
TP2.5-15	15.0	5.0	
TP2.5-16	16.0	5.0	

PARTNO	A	B	PACKAGE
TP2.5-17	17.0	5.0	1000
TP2.5-18	18.0	5.0	
TP2.5-19	19.0	5.0	
TP2.5-20	20.0	5.0	
TP2.5-21	21.0	5.0	
TP2.5-22	22.0	5.0	
TP2.5-23	23.0	5.0	
TP2.5-24	24.0	5.0	
TP2.5-25	25.0	5.0	
TP2.5-26	26.0	5.0	
TP2.5-27	27.0	5.0	
TP2.5-28	28.0	5.0	

THREADED SPACER



- ◆ MATERIAL: NYLON 66 (UL)
- ◆ FLAME CLASS: 94V-2/94V-0
- ◆ COLOR: NATURAL/BLACK
- ◆ UNIT: mm

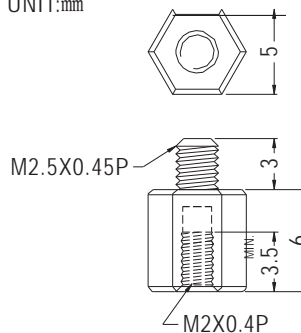

PARTNO	PACKAGE
TP2.5-2-6	1000



THREADED SPACER

- ◆ MATERIAL: NYLON 66 (UL)
- ◆ FLAME CLASS: 94V-2/94V-0
- ◆ COLOR: NATURAL/BLACK
- ◆ UNIT: mm

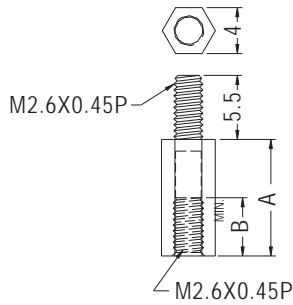
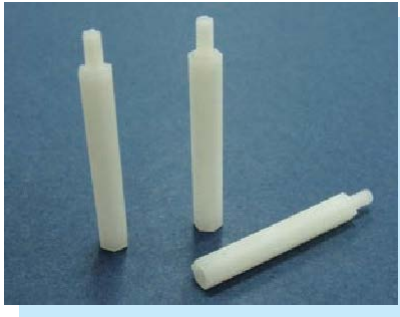

PARTNO	A	B	PACKAGE
TP2.6-4	4.0	2.0	1000
TP2.6-5	5.0	3.0	
TP2.6-6	6.0	4.0	
TP2.6-7	7.0	5.0	
TP2.6-8	8.0		
TP2.6-9	9.0		
TP2.6-10	10.0		
TP2.6-11	11.0		
TP2.6-12	12.0		
TP2.6-13	13.0		
TP2.6-14	14.0		
TP2.6-15	15.0		
TP2.6-16	16.0		

PARTNO	A	B	PACKAGE
TP2.6-17	17.0	5.5	1000
TP2.6-18	18.0		
TP2.6-19	19.0		
TP2.6-20	20.0		
TP2.6-21	21.0		
TP2.6-22	22.0		
TP2.6-23	23.0		
TP2.6-24	24.0		
TP2.6-25	25.0		
TP2.6-26	26.0		
TP2.6-27	27.0		
TP2.6-28	28.0		

THREADED SPACER

- ◆ MATERIAL: NYLON 66 (UL)
- ◆ FLAME CLASS: 94V-2/94V-0
- ◆ COLOR: NATURAL/BLACK
- ◆ UNIT: mm

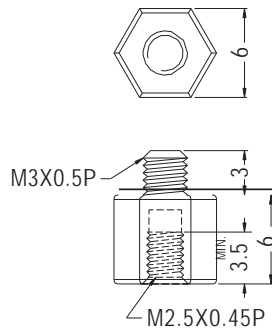

PART NO	PACKAGE
TP3-2.5-6	1000

THREADED SPACER

- ◆ MATERIAL: NYLON 66 (UL)
- ◆ FLAME CLASS: 94V-2/94V-0
- ◆ COLOR: NATURAL/BLACK
- ◆ UNIT: mm

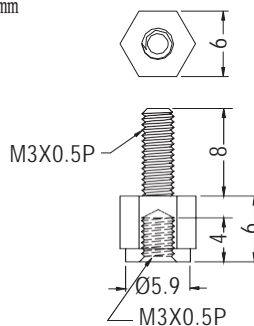

PART NO	PACKAGE
TP3-6L	1000



THREADED SPACER



- ◆ MATERIAL: NYLON 66 (UL)
- ◆ FLAME CLASS: 94V-2/94V-0
- ◆ COLOR: NATURAL/BLACK
- ◆ UNIT: mm

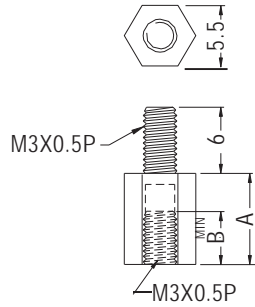

- ◆ MATERIAL: NYLON 66 (UL)
- ◆ FLAME CLASS: 94V-2/94V-0
- ◆ COLOR: NATURAL/BLACK/WHITE
- ◆ UNIT: mm

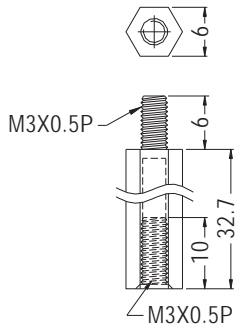

PART NO	PACKAGE
TP-32.7L	1000

PART NO	A	B	PACKAGE
TP-4	4.0	3.0	1000
TP-5	5.0	3.0	
TP-6	6.0	4.0	
TP-7	7.0	5.0	
TP-7.5	7.5	5.0	
TP-8	8.0	6.0	
TP-8.5	8.5	6.0	
TP-9	9.0	6.0	
TP-10	10.0	6.0	
TP-10.5	10.5	6.0	
TP-11	11.0	6.0	
TP-12A	12.0	6.0	
TP-12	12.7	6.0	

PART NO	A	B	PACKAGE
TP-13	13.0	6.0	1000
TP-14	14.0	6.0	
TP-15	15.0	6.0	
TP-15.5	15.5	6.0	
TP-16	16.0	6.0	
TP-16.5	16.5	6.0	
TP-17	17.0	6.0	
TP-18	18.0	6.0	
TP-18.5	18.5	6.0	
TP-19	19.0	6.0	
TP-20	20.0	8.0	
TP-21	21.0	6.0	
TP-22	22.0	6.0	
TP-24.5	24.5	6.0	
TP-25	25.0	6.0	
TP-27	27.0	6.0	
TP-28	28.0	6.0	
TP-28.5	28.5	6.0	
TP-30	30.0	8.0	
TP-33	33.0	6.0	
TP-34.5	34.5	6.0	
TP-35	35.0	6.0	
TP-36	36.0	6.0	
TP-40	40.0	6.0	
TP-45	45.0	6.0	
TP-53.5	53.5	6.0	
TP-55.5	55.5	8.0	

THREADED SPACER



- ◆ MATERIAL: NYLON 66 (UL)
- ◆ FLAME CLASS: 94V-2/94V-0
- ◆ COLOR: NATURAL/BLACK
- ◆ UNIT: mm

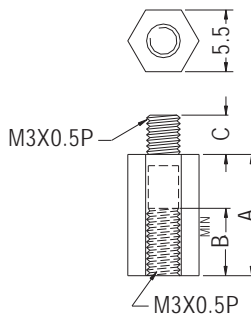

PART NO	A	B	C	PACKAGE
TP-5S	5.0	4.0	3.5	1000
TP-5SM	5.0	4.0	5.0	
TP-6S	6.0	4.0	5.0	
TP-7-4	7.0	5.0	4.0	
TP-9-4	9.0	6.0	4.0	
TP-10.8	10.8	6.0	3.5	
TP-11.2	11.2	6.0	3.5	
TP-16S	16.0	6.0	4.0	
TP-18S	18.0	6.0	5.0	
TP-20S	20.0	8.0	5.0	

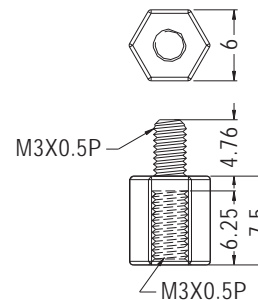
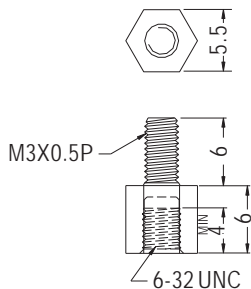

PART NO	PACKAGE
TPS632-6	1000

PART NO	PACKAGE
TP3-7.5	1000



THREADED SPACER



- ◆ MATERIAL: NYLON 66 (UL)
- ◆ FLAME CLASS: 94V-2/94V-0
- ◆ COLOR: NATURAL/BLACK
- ◆ UNIT: mm

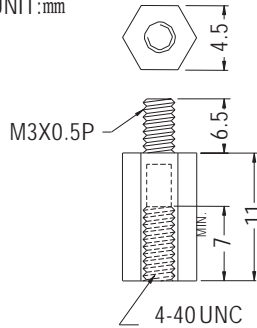

PART NO	PACKAGE
TPS44-11	1000

THREADED SPACER

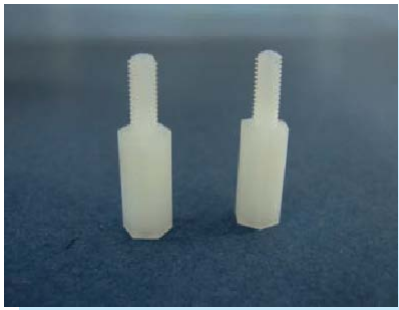

- ◆ MATERIAL: NYLON 66 (UL)
- ◆ FLAME CLASS: 94V-2/94V-0
- ◆ COLOR: NATURAL/BLACK
- ◆ UNIT: mm

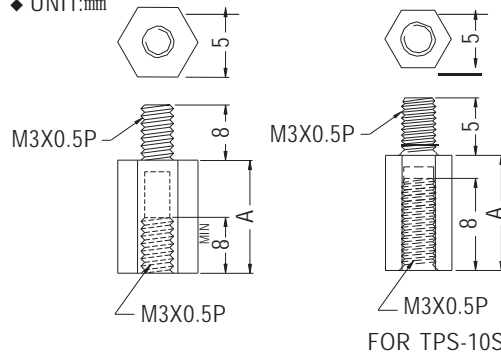

PART NO	A	PACKAGE
TPS-10	10.0	1000
TPS-10S	10.0	
TPS-12	12.0	
TPS-15	15.0	
TPS-18	18.0	
TPS-20	20.0	
TPS-25	25.0	

FOR TPS-10S

THREADED SPACER



- ◆ MATERIAL: NYLON 66 (UL)
- ◆ FLAME CLASS: 94V-2/94V-0
- ◆ COLOR: NATURAL/BLACK
- ◆ UNIT: mm

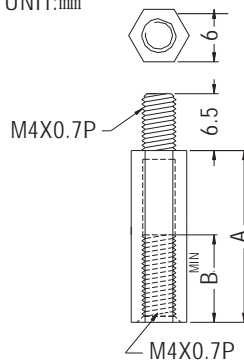

PART NO	A	B	PACKAGE
TPS4-13	13.0	6.0	1000
TPS4-30	30.0	10.0	
TPS4-55	55.0	10.0	

THREADED SPACER



- ◆ MATERIAL: NYLON 66 (UL)
- ◆ FLAME CLASS: 94V-2/94V-0
- ◆ COLOR: NATURAL/BLACK
- ◆ UNIT: mm

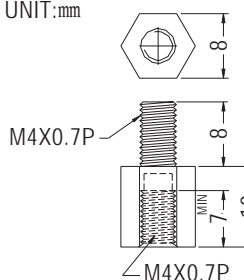

PART NO	PACKAGE
TP4-10L	1000

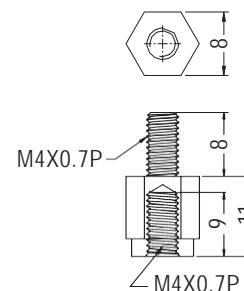

PART NO	PACKAGE
TP4-11R	1000



THREADED SPACER

- ◆ MATERIAL: NYLON 66 (UL)
- ◆ FLAME CLASS: 94V-2/94V-0
- ◆ COLOR: NATURAL/BLACK
- ◆ UNIT: mm

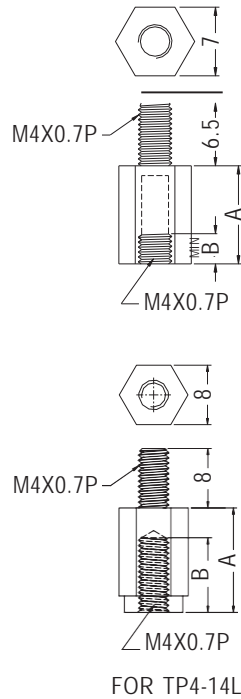

PART NO	A	B	PACKAGE
TP4-6	6.0	4.0	1000
TP4-8	8.0	6.0	
TP4-10	10.0	6.0	
TP4-12	12.0	6.0	
TP4-13	13.0	6.0	
TP4-14	14.0	6.0	
★ TP4-14L	14.0	10.0	
TP4-15	15.0	6.0	
TP4-16	16.0	7.0	
TP4-17	17.0	7.0	
TP4-19	19.0	7.0	
TP4-20	20.0	8.0	
TP4-25	25.0	8.0	
TP4-27	27.0	8.0	
TP4-30	30.0	8.0	
TP4-34	34.0	8.0	
TP4-35	35.0	8.0	
TP4-37	37.0	8.0	
TP4-40	40.0	8.0	
TP4-45	45.5	8.0	
TP4-57	57.0	8.0	

1

THREADED SPACER

- ◆ MATERIAL: NYLON 66 (UL)
- ◆ FLAME CLASS: 94V-2/94V-0
- ◆ COLOR: NATURAL/BLACK
- ◆ UNIT: mm

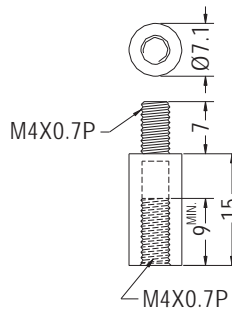

PART NO	PACKAGE
TPR4-15	1000

THREADED SPACER

- ◆ MATERIAL: NYLON 66 (UL)
- ◆ FLAME CLASS: 94V-2/94V-0
- ◆ COLOR: NATURAL/BLACK
- ◆ UNIT: mm

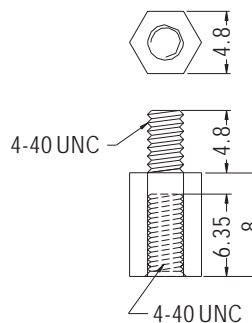

PART NO	PACKAGE
TP440-8S	1000



THREADED SPACER



- ◆ MATERIAL: NYLON 66 (UL)
- ◆ FLAME CLASS: 94V-2/94V-0
- ◆ COLOR: NATURAL/BLACK
- ◆ UNIT: mm

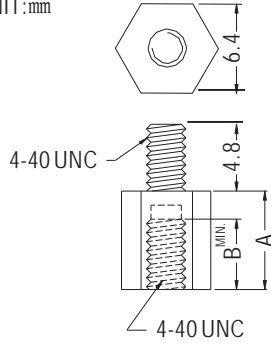

PARTNO	A	B	PACKAGE
TP440-6.4	6.4	4.0	1000
TP440-6.4-4.8	6.4	4.8	
TP440-7	7.0	4.0	
TP440-9.5	9.5	6.0	
TP440-12.7	12.7	6.0	
TP440-15.9	15.9	6.0	
TP440-19.1	19.1	6.0	
TP440-28.7	28.7	6.0	

THREADED SPACER



- ◆ MATERIAL: NYLON 66 (UL)
- ◆ FLAME CLASS: 94V-2/94V-0
- ◆ COLOR: NATURAL/BLACK
- ◆ UNIT: mm

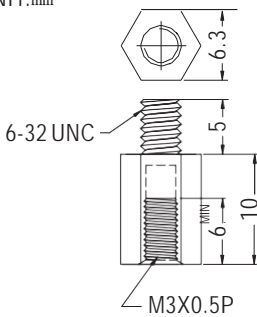

PARTNO	PACKAGE
TP632-M310	1000

THREADED SPACER



- ◆ MATERIAL: NYLON 66 (UL)
- ◆ FLAME CLASS: 94V-2/94V-0
- ◆ COLOR: NATURAL/BLACK
- ◆ UNIT: mm

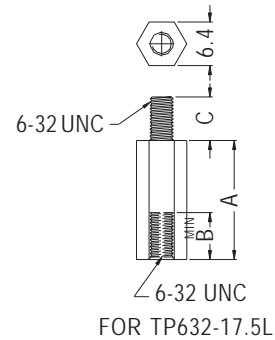
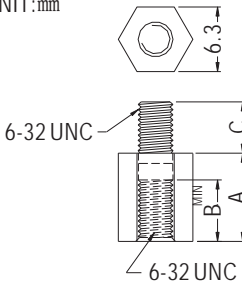

PARTNO	A	B	C	PACKAGE	
TP632-5	5.0	3.0	6.0	1000	
TP632-5.5	5.5	3.5			
TP632-6	6.0	4.0			
TP632-6.3	6.3	4.0			
TP632-8	8.0	6.0			
TP632-9	9.0	6.0			
TP632-10	10.0	6.0			
TP632-11	11.0	6.0			
TP632-12	12.0	6.0			
TP632-12.7	12.7	6.0			
TP632-15.9	15.9	6.0			
TP632-17.5L	17.5	6.4			6.4
TP632-19.1	19.1	6.0			6.0
TP632-25.4	25.4	6.0			
TP632-28.6	28.6	9.5			
TP632-31.8	31.8	6.0			
TP632-51	51.0	6.0			

PARTNO	A	B	C	PACKAGE
TP632-5S	5.0	3.0	5.0	1000
TP632-5.5S	5.5	3.5		
TP632-6S	6.0	4.0		
TP632-6.3S	6.3	4.0		
TP632-8S	8.0	6.0		
TP632-9S	9.0	6.0		
TP632-10S	10.0	6.0		
TP632-11S	11.0	6.0		
TP632-12S	12.0	6.0		
TP632-12.7S	12.7	6.0		
TP632-15.9S	15.9	6.0		
TP632-19.1S	19.1	6.0		
TP632-25.4S	25.4	6.0		
TP632-31.8S	31.8	6.0		



THREADED SPACER

- ◆ MATERIAL: NYLON 66 (UL)
- ◆ FLAME CLASS: 94V-2/94V-0
- ◆ COLOR: NATURAL/BLACK
- ◆ UNIT: mm

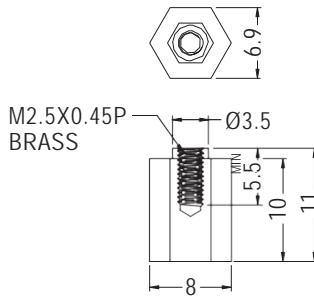

PART NO	PACKAGE
HPB2.5-10	1000

THREADED SPACER

- ◆ MATERIAL: NYLON 66 (UL)
- ◆ FLAME CLASS: 94V-2/94V-0
- ◆ COLOR: NATURAL/BLACK
- ◆ UNIT: mm

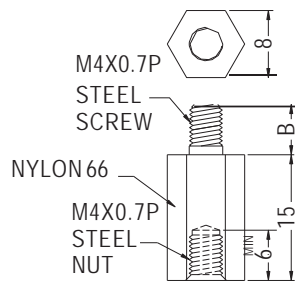

PART NO	B	PACKAGE
MTPA4-15	6.0	1000
★ MTPA4-15L	8.0	

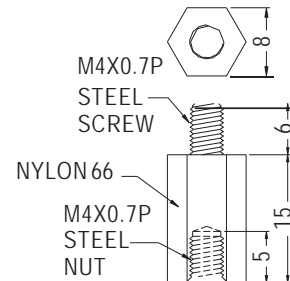

PART NO	PACKAGE
★ MTPA4-15-1	1000

THREADED SPACER

- ◆ MATERIAL: NYLON 66 (UL)
- ◆ FLAME CLASS: 94V-2/94V-0
- ◆ COLOR: NATURAL/BLACK
- ◆ UNIT: mm

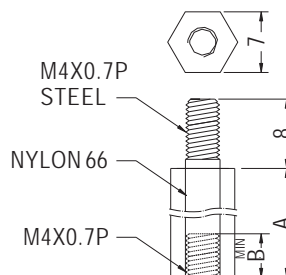

PART NO	A	B	PACKAGE
MTPC4-20	20.0	10.0	1000
MTPC4-57	57.0	10.0	



THREADED SPACER



- ◆ MATERIAL: NYLON 66 (UL)
- ◆ FLAME CLASS: 94V-2/94V-0
- ◆ COLOR: NATURAL/BLACK
- ◆ UNIT: mm

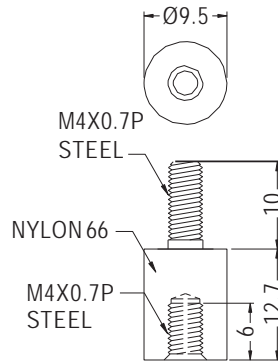

PART NO	PACKAGE
MTP4-12.7	1000

SILICON SPACER



- ◆ TERMINAL MAT'L: STEEL
- ◆ FLAME CLASS: SILICON RUBBER
- ◆ COLOR: GRAY
- ◆ UNIT: mm

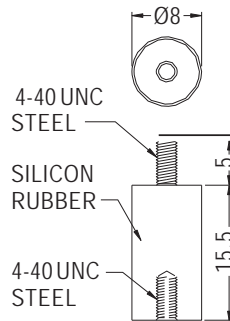

PART NO	PACKAGE
SITP-15.5	1000

THREADED SPACER



- ◆ MATERIAL: NYLON 66 (UL)
- ◆ FLAME CLASS: 94V-2/94V-0
- ◆ COLOR: NATURAL/BLACK
- ◆ UNIT: mm

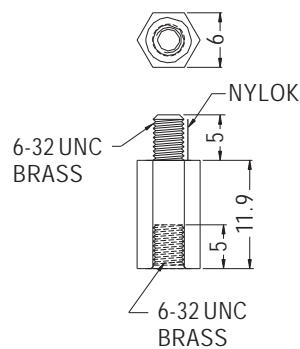

PART NO	PACKAGE
MTPD632-11.9	1000



THREADED SPACER

- ◆ MATERIAL:BRASS
- ◆ UNIT:mm

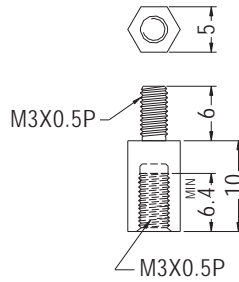

PART NO	PACKAGE
TP-10BA	1000

THREADED SPACER

- ◆ MATERIAL:STEEL/SUS
- ◆ UNIT:mm

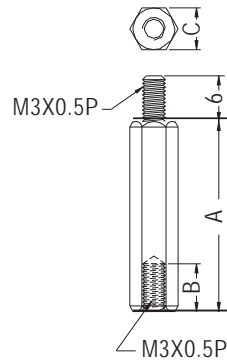

PART NO	A	B	C	MATERIAL	PACKAGE
TP-25ST	25.0	6.0	5.0	STEEL	500
TP-30SUS	30.0				
TP-18SUS	18.0	8.0	5.5	SUS	
TP-55SUS	54.9				

THREADED SPACER

- ◆ MATERIAL:STEEL
- ◆ UNIT:mm

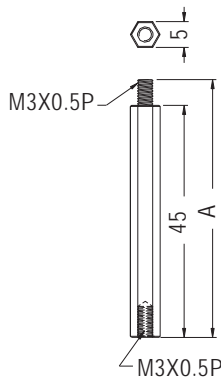

PART NO	A	PACKAGE
TP3-45ST	51.0	500
TP3-45LST	52.0	

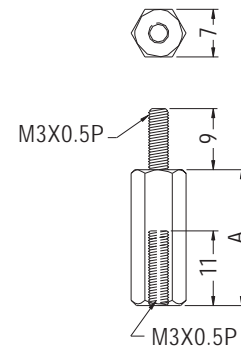

PART NO	A	PACKAGE
TPB3-20NI	20.0	500
TPB3-40NI	40.0	

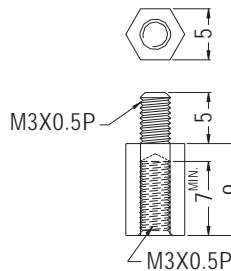

PART NO	PACKAGE
TP3-9ST	1000

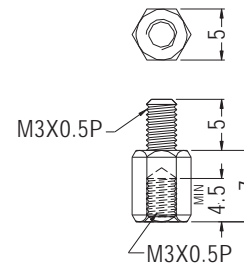

PART NO	PACKAGE
TPS3-7ST	1000



THREADED SPACER

- ◆ MATERIAL:SUS
- ◆ UNIT:mm

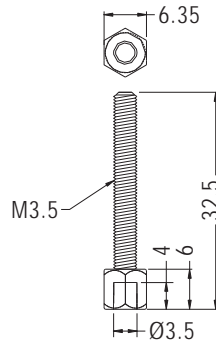

PART NO	PACKAGE
TP-6ST	500

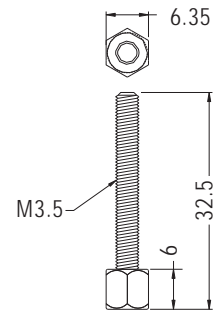

PART NO	PACKAGE
TP-6ST-1	500

THREADED SPACER

- ◆ MATERIAL:BRASS
- ◆ UNIT:mm

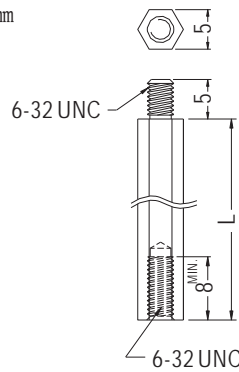

PART NO	L	PACKAGE
TP632-19.05BA	19.05	500
TP632-25.4BA	25.4	

THREADED SPACER



- ◆ MATERIAL:NYLON 66 (UL)
- ◆ FLAME CLASS:94V-2/94V-0
- ◆ COLOR:NATURAL/BLACK
- ◆ UNIT:mm

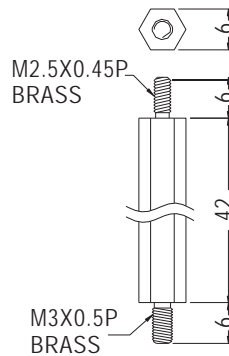

PART NO	PACKAGE
TPIM2.5-3-42	500

THREADED SPACER

- ◆ MATERIAL:NYLON 6
- ◆ COLOR:NATURAL
- ◆ UNIT:mm

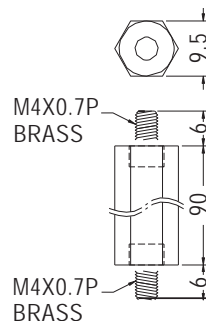

PART NO	PACKAGE
TPIM4-90	500



THREADED SPACER



- ◆ MATERIAL: NYLON 66 (UL)
- ◆ FLAME CLASS: 94V-2/94V-0
- ◆ COLOR: NATURAL/BLACK
- ◆ UNIT: mm

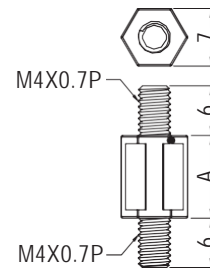
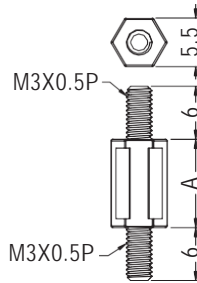

PARTNO	A	PACKAGE
HPI3-5	5.0	1000
HPI3-10	10.0	
HPI3-15	15.0	

PARTNO	A	PACKAGE
HPI4-5	5.0	1000
HPI4-10	10.0	
HPI4-15	15.0	
HPI4-19	19.0	

THREADED SPACER

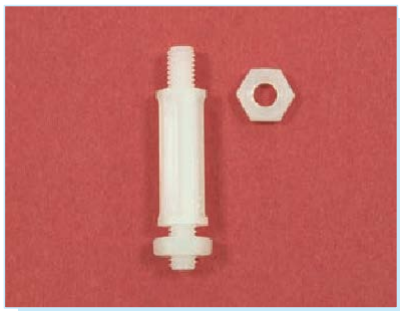

- ◆ MATERIAL: NYLON 66 (UL)
- ◆ FLAME CLASS: 94V-2/94V-0
- ◆ COLOR: NATURAL/BLACK
- ◆ UNIT: mm

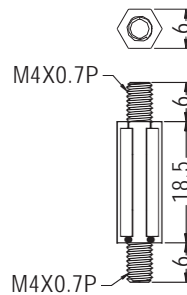

PARTNO	PACKAGE
HPIB4-18.5	1000

THREADED SPACER



- ◆ MATERIAL: NYLON 66 (UL)
- ◆ FLAME CLASS: 94V-2/94V-0
- ◆ COLOR: NATURAL/BLACK
- ◆ UNIT: mm

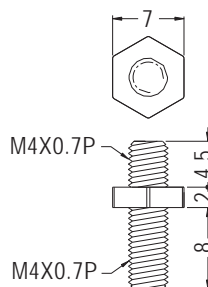

PARTNO	PACKAGE
HPIA4-2	1000

SPACER SUPPORT

- ◆ MATERIAL: NYLON 66 (UL)
- ◆ FLAME CLASS: 94V-2/94V-0
- ◆ COLOR: NATURAL/BLACK
- ◆ UNIT: mm



P.C.B Ø3.0
THICKNESS 1.6

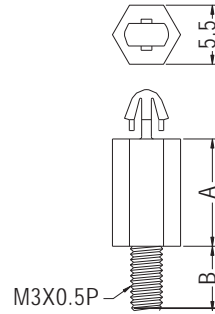

PART NO	A	B	PACKAGE
SCBA-3	3.0	6.3	1000
★ SCBA-3S	3.0	3.0	
SCBA-4	4.0	6.3	
SCBA-5	5.0		
SCBA-6	6.0		
SCBA-6S	6.0	4.5	
SCBA-7	7.0	6.3	
SCBA-8	8.0		
SCBA-9	9.0		
SCBA-10	10.0		
SCBA-11	11.0		
SCBA-12	12.0		
SCBA-13	13.0		
SCBA-14	14.0		
SCBA-15	15.0		
SCBA-16	16.0		



SPACER SUPPORT



- ◆ MATERIAL: NYLON 66 (UL)
- ◆ FLAME CLASS: 94V-2/94V-0
- ◆ COLOR: WHITE/BLACK
- ◆ UNIT: mm



P.C.B Ø3.5
THICKNESS 1.6

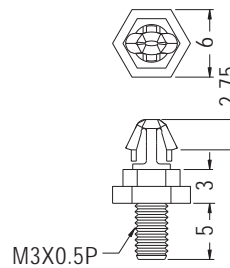

PART NO	PACKAGE
SCBB-3	1000

SPACER SUPPORT

- ◆ MATERIAL: NYLON 66 (UL)
- ◆ FLAME CLASS: 94V-2/94V-0
- ◆ COLOR: NATURAL/BLACK
- ◆ UNIT: mm



P.C.B Ø2.5
THICKNESS 1.6

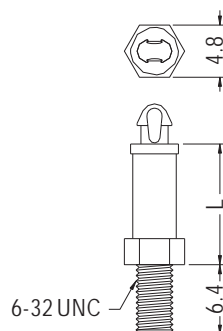

PART NO	L	PACKAGE
SCBS632-3.2	3.2	1000
SCBS632-4.8	4.8	
SCBS632-6.4	6.4	
SCBS632-7.9	7.9	
SCBS632-9.5	9.5	
SCBS632-11.1	11.1	
SCBS632-12.7	12.7	
SCBS632-14.3	14.3	
SCBS632-15.9	15.9	



SPACER SUPPORT



- ◆ MATERIAL: NYLON 66 (UL)
- ◆ FLAME CLASS: 94V-2/94V-0
- ◆ COLOR: NATURAL/BLACK
- ◆ UNIT: mm

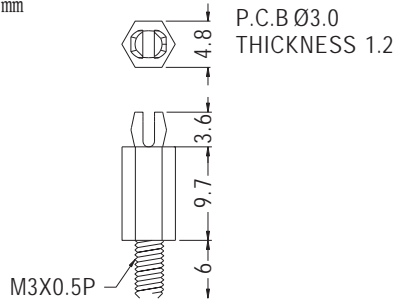

PARTNO	PACKAGE
MSPA3-9.7	1000

SPACER SUPPORT



- ◆ MATERIAL: NYLON 66 (UL)
- ◆ FLAME CLASS: 94V-2/94V-0
- ◆ COLOR: NATURAL/BLACK
- ◆ UNIT: mm

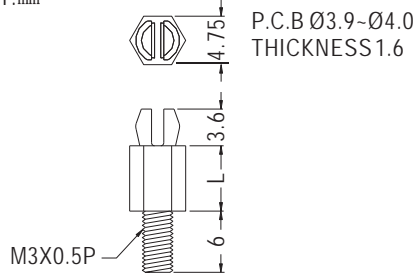

PARTNO	L	PACKAGE
MSPG3-3.2	3.2	1000
MSPG3-4.8	4.8	
MSPG3-6.4	6.4	
MSPG3-9.5	9.5	
MSPG3-12.7	12.7	
MSPG3-15.9	15.9	
MSPG3-19.1	19.1	
MSPG3-22.2	22.2	

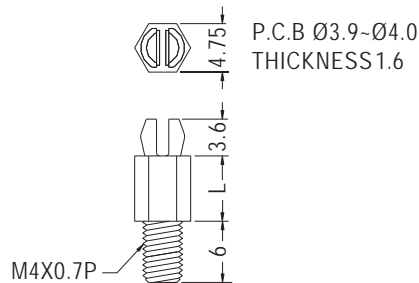

PARTNO	L	PACKAGE
MSPG4-3.2	3.2	1000
MSPG4-4.8	4.8	
MSPG4-6.4	6.4	
MSPG4-9.5	9.5	
MSPG4-12.7	12.7	
MSPG4-15.9	15.9	
MSPG4-19.1	19.1	
MSPG4-22.2	22.2	

SPACER SUPPORT



- ◆ MATERIAL: NYLON 66 (UL)
- ◆ FLAME CLASS: 94V-2/94V-0
- ◆ COLOR: NATURAL/BLACK/GRAY
- ◆ UNIT: mm

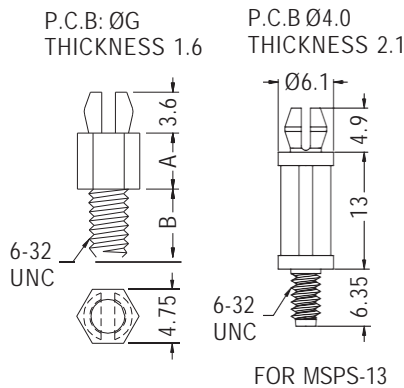

PARTNO	A	B	G	PACKAGE
MSPS-2S	2.0	3.0	4.0	2000
MSPS-3	3.2	6.0		
MSPS-5	4.8	6.0	3.9-4.0	1000
MSPS-6	6.4	6.0		
MSPS-12.7	12.7	6.0		
MSPS-13	15.9	6.0	4.0	
MSPS-15.9	15.9	6.0		
MSPS-19.1	19.1	6.0	3.9-4.0	
MSPS-22.2	22.2	6.0		



SPACER SUPPORT

- ◆ MATERIAL: NYLON 66 (UL)
- ◆ FLAME CLASS: 94V-2/94V-0
- ◆ COLOR: NATURAL/BLACK
- ◆ UNIT: mm



P.C.B Ø4.0
THICKNESS 1.2-1.7

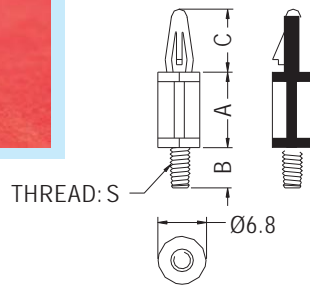

PARTNO	A	B	C	S	PACKAGE
SCB-6	6.3	7.8	10.0	6-32 UNC	1000
SCB-10	9.5	7.8	10.0		
SCB-12	12.7	7.8	10.0		
SCB-15	15.9	7.8	10.0		
SCB-15A	15.9	4.8	10.0		

P.C.B Ø4.0
THICKNESS 1.2-1.7

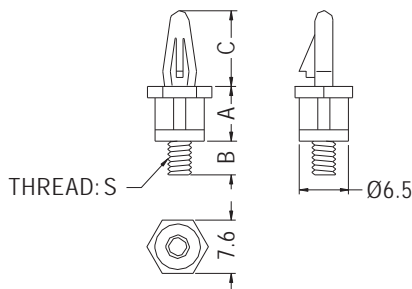

PARTNO	A	B	C	S	PACKAGE
SCB-8.5S	8.5	4.5	10.0	6-32 UNC	1000
SCB-10SA	10.0	4.5	10.0		

P.C.B Ø4.0
THICKNESS 1.2-1.7

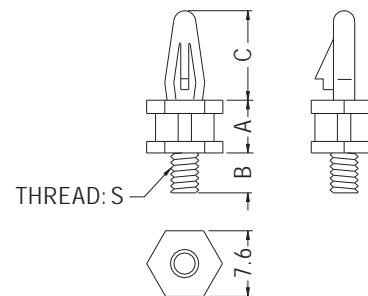

PARTNO	A	B	C	S	PACKAGE
SCB-6SM3	6.3	4.8	10.0	M3X0.5P	1000
SCB-6S	6.3	4.8	10.0	6-32 UNC	
SCB-8S	8.0	4.5	10.0		
SCB-10S	10.0	4.5	10.0		

SPACER SUPPORT

- ◆ MATERIAL: NYLON 66 (UL)
- ◆ FLAME CLASS: 94V-2/94V-0
- ◆ COLOR: NATURAL/BLACK
- ◆ UNIT: mm



P.C.B Ø4.0
THICKNESS: E

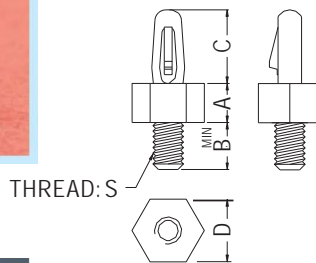

FOR SCB4-5

P.C.B Ø4.0
THICKNESS: E

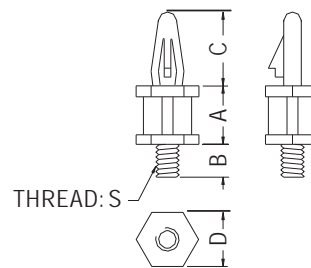

FOR SCB4-6, SCB4-6A
SCB4-16

P.C.B Ø4.0
THICKNESS: E

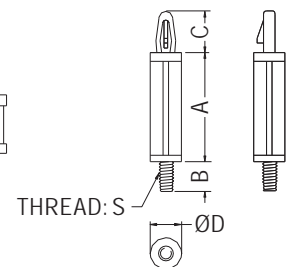

FOR SCB4-23.8,
SCB4-30



PARTNO	A	B	C	D	E	S	PACKAGE
SCB4-5	5.0	6.0	9.4	8.0	1.6	M4X0.7P	1000
SCB4-6	6.3	4.8	10.7	7.6	1.2~1.7		
SCB4-6A	6.3	6.4	10.7	7.6	1.2~1.7		
SCB4-16	15.9	6.4	10.0	8.0	1.6~1.8		
SCB4-23.8	23.8	6.35	9.0	6.8	1.6		
★ SCB4-30	30.0	6.35	9.0	6.8	1.6		



SPACER SUPPORT

NEW

- ◆ MATERIAL: NYLON 66 (UL)
- ◆ FLAME CLASS: 94V-2/94V-0
- ◆ COLOR: NATURAL/BLACK/WHITE
- ◆ UNIT: mm

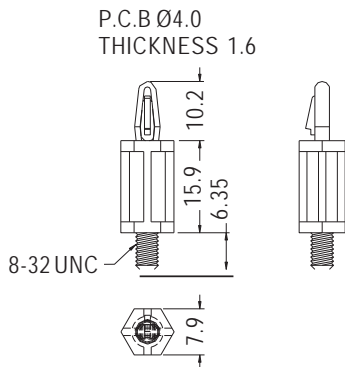

PART NO	PACKAGE
SCB832-15.9	1000

1

SPACER SUPPORT

- ◆ MATERIAL: NYLON 66 (UL)
- ◆ FLAME CLASS: 94V-2/94V-0
- ◆ COLOR: NATURAL/BLACK
- ◆ UNIT: mm

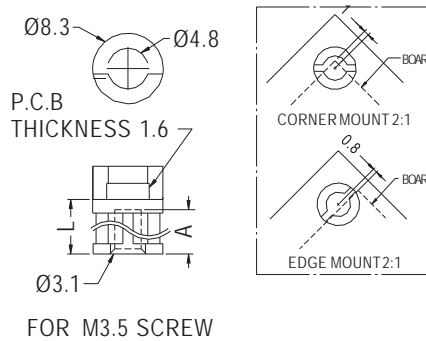
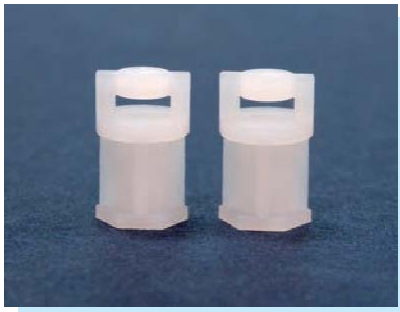

PART NO	A	L	PACKAGE
TCEH-6.4	5.2	6.4	1000
TCEH-9.5	7.9	9.5	
TCEH-12.7	7.9	12.7	
TCEH-15.9	7.9	15.9	

SPACER SUPPORT

- ◆ MATERIAL: NYLON 66 (UL)
- ◆ FLAME CLASS: 94V-2/94V-0
- ◆ COLOR: NATURAL/BLACK
- ◆ UNIT: mm

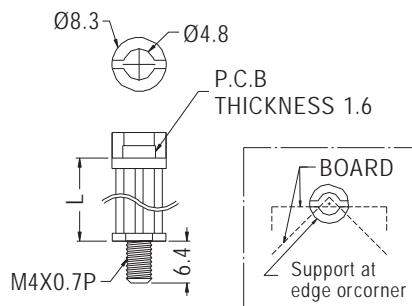

PART NO	L	PACKAGE
TCEP4-6.4	6.4	1000
TCEP4-9.5	9.5	
TCEP4-12.7	12.7	
TCEP4-15.9	15.9	



SPACER SUPPORT



- ◆ MATERIAL:PC(UL)
- ◆ FLAME CLASS:94V-2/94V-0
- ◆ COLOR:WHITE
- ◆ UNIT:mm

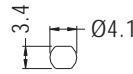
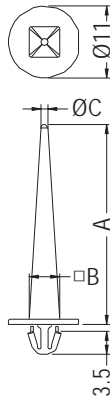

MOUNTING HOLE
THICKNESS:D

PART NO	A	B	C	D	PACKAGE
MCFG-3010	30.5	4.65	0.8	1.0	1000
MCFG-35810	35.8	4.65	1.05	1.05	

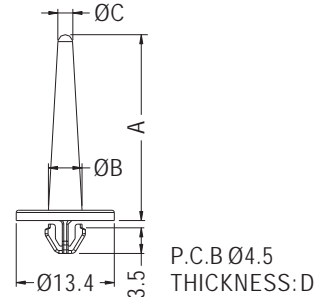
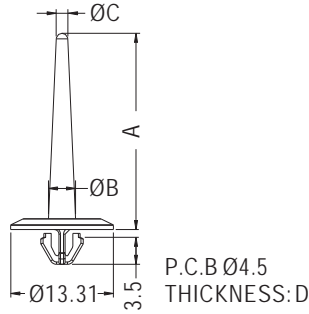

PART NO	A	B	C	D	PACKAGE
MCFA-2508	25.4	3.5	1.5	0.6~0.8	500
MCFA-2511	25.4	3.5	1.5	0.8~1.1	

PART NO	A	B	C	D	PACKAGE
MCFC-2508	25.4	4.6	2.0	0.6~0.8	1000

- ◆ MATERIAL:PC
- ◆ COLOR:NATURAL/WHITE
- ◆ UNIT:mm

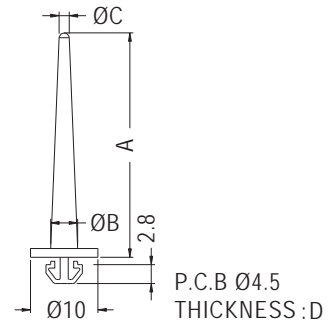
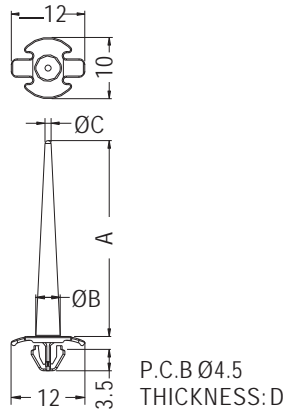

PART NO	A	B	C	D	PACKAGE
★ MCFD-2810	28.0	4.0	1.0	0.8~1.0	1000
MCFD-3210	32.0	4.0	1.0	0.8~1.0	

PART NO	A	B	C	D	PACKAGE
★ MCFL-3310	33.3	4.0	1.5	1.0	1000

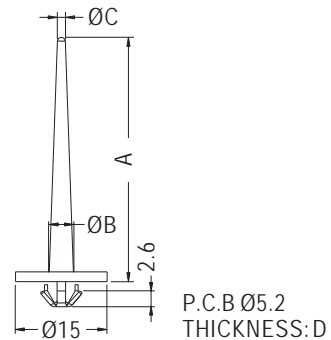
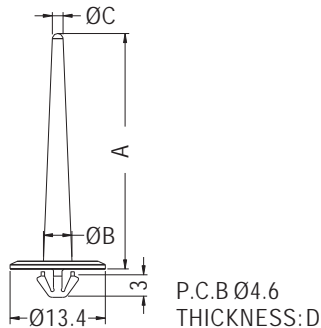

PART NO	A	B	C	D	PACKAGE
MCF-3305	33.1	4.0	1.5	0.6	500
MCF-3308	33.1	4.0	1.5	0.5~0.8	

PART NO	A	B	C	D	PACKAGE
MCF-2310	23.5	4.5	1.6	0.8~1.0	500
MCF-4213	40.0	3.95	1.3	1.0~1.3	



SPACERSUPPORT



- ◆ MATERIAL:PC (UL)
- ◆ FLAME CLASS:94V-2/94V-0
- ◆ COLOR:WHITE
- ◆ UNIT:mm

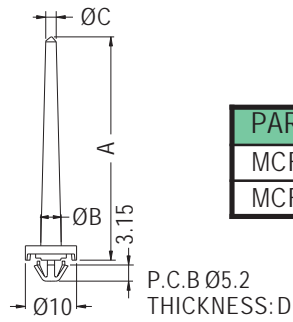

PART NO	A	B	C	D	PACKAGE
MCF-428	42.6	4.0	1.05	0.6-0.8	500
MCF-2908	29.0	4.0	1.05	0.6-0.8	

SPACERSUPPORT



- ◆ MATERIAL:PC (UL)
- ◆ FLAME CLASS:94V-2
- ◆ COLOR:NATURAL/TRANSPARENT
- ◆ UNIT:mm

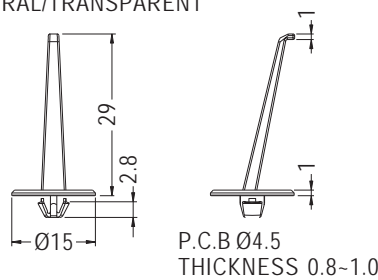

PART NO	PACKAGE
MCF-1	1000

SPACERSUPPORT

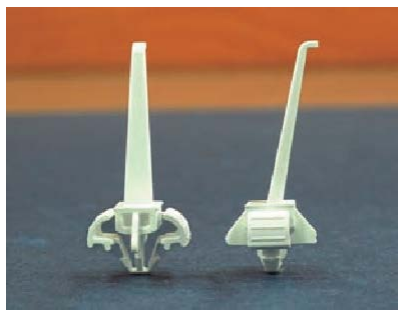

- ◆ MATERIAL:PC (UL)
- ◆ FLAME CLASS:94V-0
- ◆ COLOR:NATURAL/WHITE TRANSPARENT
- ◆ UNIT:mm

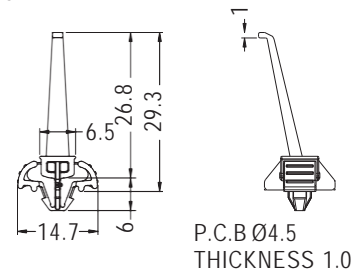

PART NO	PACKAGE
MCFF-5	1000

SPACERSUPPORT



- ◆ MATERIAL:PC (UL)
- ◆ FLAME CLASS:94V-0
- ◆ COLOR:WHITE
- ◆ UNIT:mm

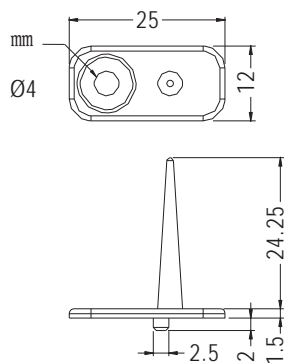

PART NO	PACKAGE
MCFJ-1	1000

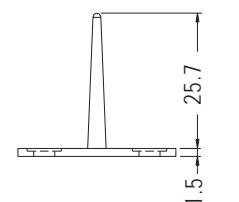
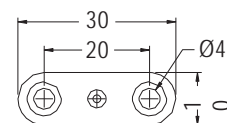

MOUNTING HOLE Ø5.0
THICKNESS 0.6-0.8

PART NO	PACKAGE
★ MCFJ-2	1000



- ◆ MATERIAL: NYLON 66 (UL)
- ◆ FLAME CLASS: 94V-2/94V-0
- ◆ COLOR: NATURAL/BLACK/GREEN/BLUE
- ◆ UNIT: mm

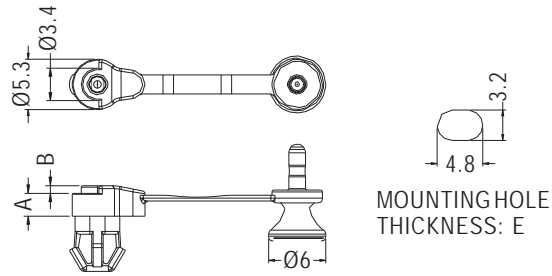

PART NO	A	B	E	PACKAGE
★ ULCO2.4-3.1	2.4	0.8	2.95	1000
ULCO2.5-1.6	2.5	0.8	1.6	
★ ULCO2.5-2.2	2.5	0.8	2.2	

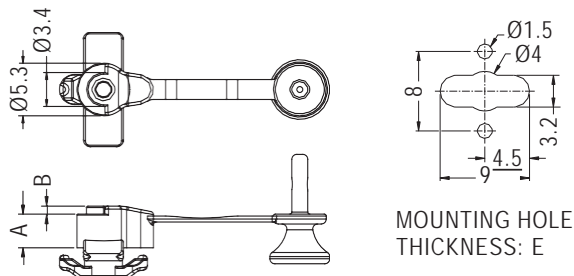

PART NO	A	B	E	PACKAGE
ULCN1.7-2.4	1.7	0.8	2.1~2.4	1000
★ ULCN2.2-1.2	2.2	0.8	1.6	
ULCN3.4-0.8	3.4	0.8	0.8	
★ ULCN3.4-2.1	3.4	0.8	2.13	
★ ULCN6.3-1.6	6.3	0.8	1.6	

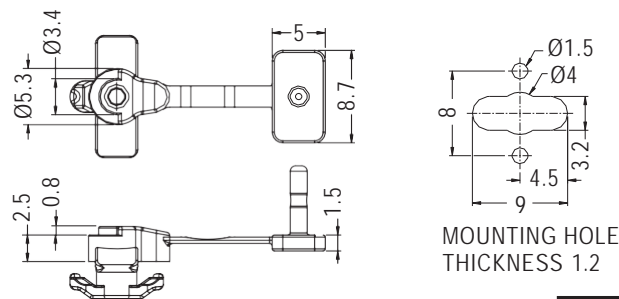

PART NO	PACKAGE
ULCN2.5-1.2	1000

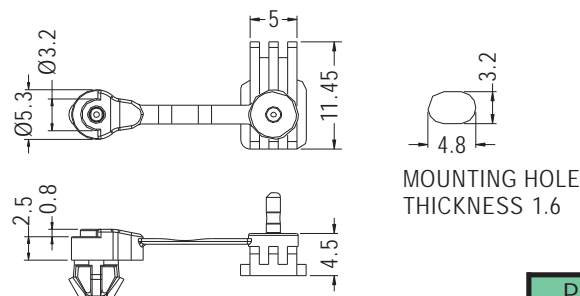

PART NO	PACKAGE
ULCW2.5-1.6	1000



- ◆ MATERIAL: NYLON 66 (UL)
- ◆ FLAME CLASS: 94V-2/94V-0
- ◆ COLOR: NATURAL/BLACK/GREEN/BLUE
- ◆ UNIT: mm

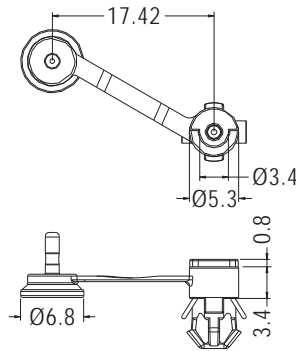
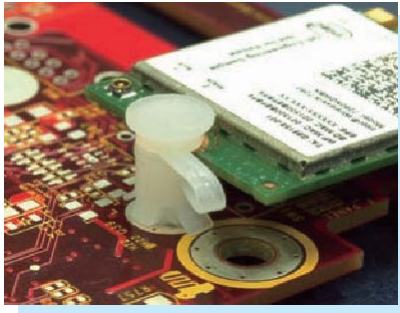

MOUNTING HOLE THICKNESS 1.6

PART NO	PACKAGE
ULCOA5-1.6	1000

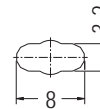
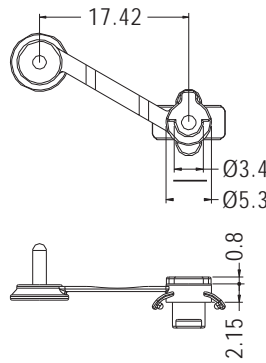

MOUNTING HOLE THICKNESS 1.6-1.8

PART NO	PACKAGE
★ ULCNA2.5-1.8	1000

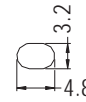
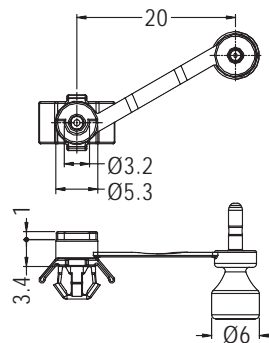

MOUNTING HOLE THICKNESS 1.6

PART NO	PACKAGE
ULCOB3.4-1.6	1000

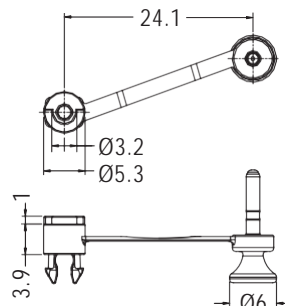

MOUNTING HOLE THICKNESS 1.6

PART NO	PACKAGE
ULCY3.9-1.6	1000



SPACER SUPPORT

NEW



- ◆ MATERIAL: NYLON 66 (UL)
- ◆ FLAME CLASS: 94V-2/94V-0
- ◆ COLOR: NATURAL/BLACK
- ◆ UNIT: mm

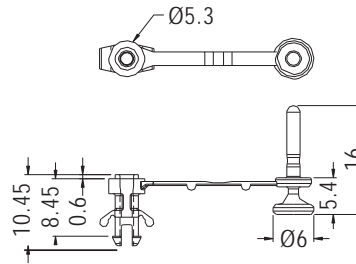

MOUNTING HOLE Ø3.5
THICKNESS 1.6-2.2

PART NO	PACKAGE
ULCOC-1	1000

1

SPACER SUPPORT

NEW



- ◆ MATERIAL: NYLON 66 (UL)
- ◆ FLAME CLASS: 94V-2/94V-0
- ◆ COLOR: NATURAL/BLACK/BLUE
- ◆ UNIT: mm

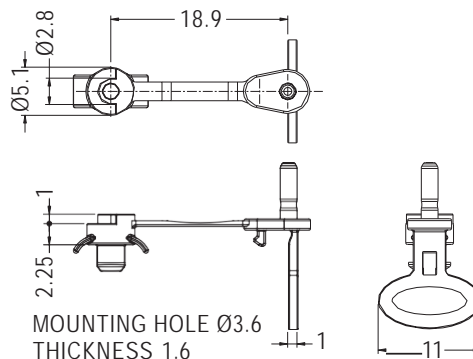

MOUNTING HOLE Ø3.6
THICKNESS 1.6

PART NO	PACKAGE
ULCOC2.2-1.6	1000

SPACER SUPPORT

NEW



- ◆ MATERIAL: NYLON 66 (UL)
- ◆ FLAME CLASS: 94V-2/94V-0
- ◆ COLOR: NATURAL/BLACK/BLUE
- ◆ UNIT: mm

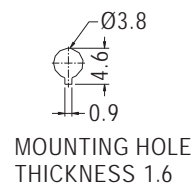
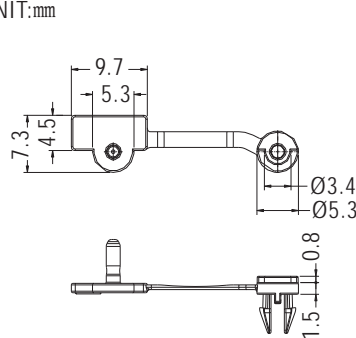

MOUNTING HOLE
THICKNESS 1.6

PART NO	PACKAGE
ULCOD1.5-1.6	1000

SPACERSUPPORT



- ◆ MATERIAL: PA66 (UL)
- ◆ SPRING MATERIAL: SWPB
- ◆ FLAME CLASS: 94V-0
- ◆ COLOR: BLACK
- ◆ UNIT: mm

NEW

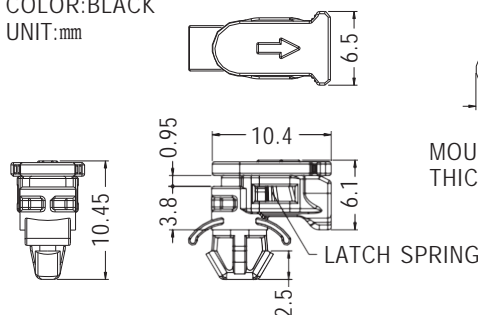

MOUNTING HOLE
THICKNESS 1.6

PART NO	PACKAGE
ULCOF-2F	1000



SPACER SUPPORT



- ◆ BODY MATERIAL:ABS(UL)
- ◆ FLAME CLASS:94HB
- ◆ COLOR:NATURAL
- ◆ UNIT:mm

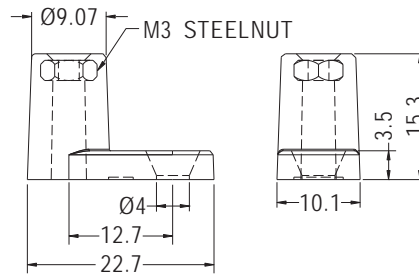

PART NO	PACKAGE
LLCB3-15	1000

1

SPACER SUPPORT

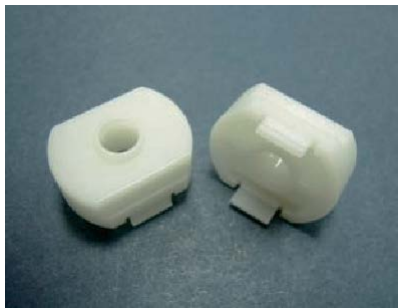

- ◆ MATERIAL:NYLON 66 (UL)
- ◆ FLAME CLASS:94V-2/94V-0
- ◆ COLOR:NATURAL/BLACK
- ◆ UNIT:mm

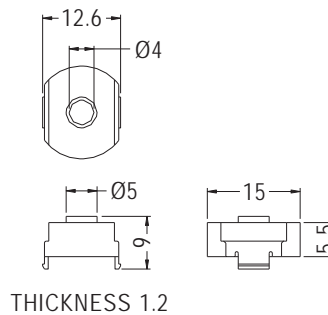

PART NO	PACKAGE
DDMC-5.5	1000

ROUND SPACER



- ◆ MATERIAL:NYLON 6(UL)
- ◆ FLAME CLASS:94V-2
- ◆ COLOR:BLACK
- ◆ UNIT:mm

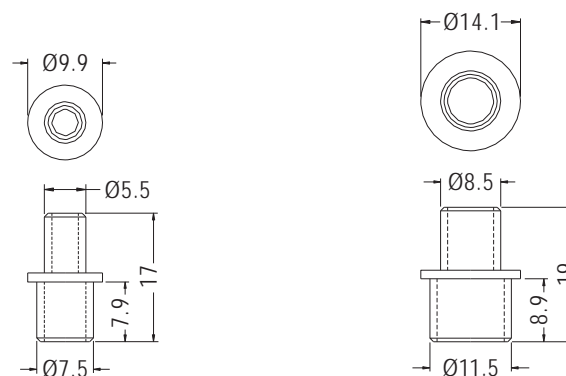

PART NO	PACKAGE
BPLT-9	1000

PART NO	PACKAGE
BPLT-13	1000

